

# **NATIONAL SCHOOL TRANSPORTATION SPECIFICATIONS and PROCEDURES**

**2005 Revised Edition**

**Adopted by:**

**THE FOURTEENTH NATIONAL CONGRESS ON  
SCHOOL TRANSPORTATION**

**Central Missouri State University  
Warrensburg, Missouri  
May 15-19, 2005**

**Co-Sponsored by:**

**National Association of State Directors of Pupil Transportation Services  
National Association for Pupil Transportation  
National School Transportation Association  
School Transportation Section, National Safety Council  
School Bus Manufacturers Technical Council  
Missouri Safety Center, Central Missouri State University**

**This publication is available from:**

**Missouri Safety Center  
Central Missouri State University  
Humphreys Suite 201  
Warrensburg, MO 64093  
Phone: (660) 543-4830  
Fax: (660) 543-4482**



# CONTENTS

Foreword.....	1
About this Document and Guiding Principles .....	4
Intended Use .....	5
Interpretations and Information; Interim Committee.....	6
School Bus Types.....	7
Bus Chassis Specifications.....	9
Air Cleaner.....	11
Axles .....	11
Brakes: General.....	11
Brakes: Hydraulic .....	12
Brakes: Air .....	12
Bumper: Front.....	12
Certification.....	13
Clutch.....	13
Color .....	14
Drive Shaft.....	14
Electrical System .....	14
Engine Fire Extinguisher .....	16
Exhaust System.....	16
Fenders: Front-Type C Vehicles.....	17
Frame .....	17
Fuel System.....	17
Governor .....	18
Heating System, Provision For .....	18
Horn .....	18
Instruments and Instrument Panel.....	18
Oil Filter.....	20
Openings .....	20
Passenger Load .....	20
Retarder System (Optional Equipment).....	20
Road Speed Control .....	20
Shock Absorbers .....	20
Steering Gear .....	21
Suspension Systems .....	21
Throttle.....	21
Tires and Rims .....	21
Transmission .....	22
Turning Radius.....	22
Undercoating.....	22

Bus Body Specifications .....	23
Aisle .....	25
Back-up Warning Alarm .....	25
Battery .....	25
Bumper: Front .....	25
Bumper: Rear .....	25
Ceiling .....	26
Certification .....	26
Chains (Tire) .....	26
Color .....	26
Communications Systems .....	26
Construction .....	27
Crossing Control Arm (Optional) .....	27
Defrosters .....	28
Doors .....	28
Emergency Exits .....	29
Emergency Equipment .....	30
Fire Suppression Systems (Optional) .....	31
Floors .....	32
Handrails .....	32
Heating and Air Conditioning Systems .....	32
Hinges .....	35
Identification .....	35
Inside Height .....	36
Insulation (Optional) .....	36
Interior .....	37
Lamps and Signals .....	37
Metal Treatment .....	39
Mirrors .....	40
Mounting .....	40
Overall Length .....	40
Overall Width .....	40
Public Address System .....	40
Retroreflective Material .....	40
Rub Rails .....	41
Seats and Restraining Barriers .....	42
Side Skirts .....	44
Steering Wheel .....	44
Steps .....	44
Step Treads .....	44
Stirrup Steps .....	45
Stop Signal Arm .....	45
Storage Compartment (Optional) .....	45
Sun Shield .....	45
Tailpipe .....	45

Towing Attachment Points.....	46
Traction Assisting Devices (Optional).....	46
Trash Container and Holding Device (Optional).....	47
Undercoating.....	47
Ventilation.....	47
Wheelhousing.....	48
Windows.....	48
Windshield Washers.....	48
Windshield Wipers.....	48
Wiring.....	48
 Specially Equipped School Bus Specifications.....	 51
Introduction.....	53
Definition.....	53
General Requirements.....	54
Aisles.....	54
Glazing.....	54
Identification.....	54
Passenger Capacity Rating.....	54
Power Lifts and Ramps.....	55
Regular Service Entrance.....	58
Restraining Devices.....	58
Seating Arrangements.....	58
Securement and Restraint System for Wheelchairs and Wheelchair-seated Occupants....	59
Special Light.....	60
Special Service Entrance.....	60
Special Service Entrance Doors.....	61
Support Equipment and Accessories.....	62
Technology and Equipment, New.....	63
 Alternative Fuels.....	 65
Introduction.....	67
General Requirements.....	67
Characteristics of Alternative Fuels.....	69
 Operations.....	 83
Introduction.....	85
School Travel Choices.....	85
School Bus Use.....	85
Buses Other Than School Buses.....	86
State Administration.....	86
Local School District Administration.....	89
Responsibilities.....	93

Operational Procedures .....	99
Training of Bus Drivers .....	121
Training of Bus Attendants .....	124
Training of Maintenance and Service Personnel .....	126
Routing and Scheduling.....	127
Maintenance of Equipment.....	132
Emergency and Rescue Procedures .....	133
Evaluation of the Student Transportation System.....	135
School Site Selection and Facility Planning.....	137
School Transportation Security and Emergency Preparedness.....	139
Transportation for Students with Disabilities and Special Health Care Needs.....	149
Laws Affecting Transportation for Students with Disabilities.....	151
Individualized Education Program (IEP).....	153
Individualized Family Service Plan (IFSP) – Process .....	153
Guidelines .....	154
Confidentiality.....	162
Development.....	162
Emergency Evacuation of Students with Disabilities.....	163
Extended School Year.....	163
Infants / Toddlers and Pre-school Children.....	165
Introduction.....	167
Transportation Services for Infants and Toddlers with Disabilities.....	168
Transportation Services for Pre-school Children with Disabilities .....	168
Head Start.....	170
Guidelines for Infants, Toddlers and Pre-School Children.....	170
School Bus Inspection.....	189
History.....	191
State Inspection Program .....	191
Inspection Procedure.....	191
The Criteria .....	191
School Bus Recommended Out-of-Service Criteria .....	192
Attachment 1 – Brake Adjustment Specifications .....	298
Attachment 2 – Steering Wheel Free Play.....	200
Attachment 3 – Inspection Methods .....	201

## APPENDICES

Appendix A – Terms and Definitions.....	211
Introduction.....	213
Appendix B – School Bus Chassis and Body.....	239
National School Bus Yellow.....	241
Bus Body Heating System Test.....	241
Placement of Retroreflective Markings and White Roof.....	251
Placement of Retroreflective Markings (front and back view).....	252
Noise Test Procedure.....	253
Retroreflective Sheeting Daytime Color Specification.....	254
School Bus Seat Upholstery Fire Block Test.....	254
Appendix C – Alternative Fuels.....	257
Bibliography.....	259
Glossary of Alternative Fuels.....	260
Alternative Fuels Comparison Chart.....	263
Appendix D – School Bus Operations.....	265
Highway Safety Program Guideline #17.....	267
School Bus Driver Application.....	272
Actions to be Taken During and Following the Observations of School Bus Routes.....	274
Guidelines for En Route Emergency Bus Evacuation Procedures.....	275
Sample Crash Reporting Form.....	278
Planning School Sites for School Bus Safety.....	285
Identification and Evaluation of School Bus Route and Hazard Marking Systems.....	287
Checklist for Identifying Potential School Bus Route Fixed Driving Hazards.....	297
Policies and Procedures for Student Management.....	301
Evaluation Checklist for School Bus Driveways in the Vicinity of the School.....	302
Student Rules.....	304
Bus Conduct Report.....	305
How to Cross the Road Safely (When Leaving the Bus).....	306
How to Cross the Road Safely (When Boarding the Bus).....	307
Recommended Procedures for School Bus Drivers at Railroad Grade Crossings.....	308
Trip Request Form.....	310
Instructions for Conducting Emergency Exit Drills.....	311
Evacuation Procedures for Activity Trips and Field Trips.....	314
Operational Guidelines for the Use of Buses Other Than School Buses.....	315
Activity Bus Use for School Activity Trips.....	321
School Bus Danger Zone.....	327
Sample Job Descriptions and Hiring New Employees.....	328

Appendix E – Transportation for Students with Disabilities and Special Health Care Needs .....	343
Special Education Department Forms .....	345
Consent for Disclosure of Medical Information and Records .....	345
Request for Medical Verification of Health Status and Needs.....	346
Medical Procedure Authorization .....	347
Student Transportation Card – Students with Disabilities .....	348
Transportation Service Requirements for Passengers with Health Concerns.....	350
Transportation Checklist.....	353
Transporting Oxygen in School Buses.....	355
Procedure for Lifting Passengers.....	356
Characteristics of Disabilities as Defined by IDEA.....	358
Sample Continuum of Transportation Services for Students with Disabilities.....	361
IDEA-Part B Final Regulations – Discipline Procedures.....	362
Resources .....	365
Appendix F – Infants, Toddlers and Pre-Schoolers .....	383
Definitions: Infants, Toddlers and Pre-school Children.....	385
Laws: Transportation of Infants, Toddlers and Pre-school Children .....	385
Definitions: Infants and Toddlers under the Individuals with Disabilities Education Act ....	388
National Highway Traffic Safety Administration Guidelines.....	390
Appendix G – Resolutions.....	395
Resolution No. 1: Driver Seat Integrated Lap/Shoulder Belts.....	397
Resolution No. 2: Seat Back Height .....	398
Resolution No. 3: Rub Rails .....	399
Resolution No. 4: Definition of School Bus .....	400
Resolution No. 5: Wheelchair WC-19 Data Collection.....	402
Resolution No. 6: Underride on School Buses .....	403
Resolution No. 7: Encouraging and Chronicling Innovation in School Transportation ..	404
Resolution No. 8: Engine Compartment Fire Protection.....	405
Resolution No. 9: School Bus Security.....	406
Resolution No. 10: Lap/Shoulder Belts in School Buses having a GVWR of 10,000 Pounds or Less .....	407
Resolution No. 11: Hours of Service .....	408
Committees .....	409
Roster of Delegates and Alternates.....	415
Roster of Attendance.....	423



## FOREWORD

The 2005 National Congress on School Transportation was the latest in a series beginning in 1939 and continuing in 1945, 1948, 1951, 1954, 1959, 1964, 1970, 1980, 1985, 1990, 1995 and 2000. All congresses (referred to as “conferences” before 2005) have been made up of official representatives of state departments of education, public safety, motor vehicles, and police or other state agencies having state-wide responsibilities for the administration of student transportation; local school district personnel; contract operators; advisors from industry; and representatives from other interested professional organizations and groups. Each conference has resulted in one or more publications that contain the recommendations of that particular conference.

The recommendation of specifications and procedures for school buses and their operation has been a major purpose of all conferences. The 1939 Conference was called for this sole purpose and formulated a set of recommended standards for school buses of 20 or more passengers. The 1945 Conference revised the 1939 recommendations and added standards for small vehicles of 10 to 18 passengers. Both standards were further revised by the 1948 Conference. There were additional revisions in 1959, and the 1964 Conference added standards for school buses to be used in transporting students with disabilities. In addition to revising standards for larger vehicles, the 1970 Conference refined the standards for school buses designed to transport fewer than 24 passengers.

Other major issues in student transportation have received attention at these national conferences. On several occasions, recommendations concerned primarily with overtaking and passing of school buses were transmitted to the National Committee on Uniform Traffic Laws and Ordinances for consideration in connection with revisions of the Uniform Vehicle Code. The 1948 Conference made recommendations on uniform records and reports for student transportation. The major purpose of the 1948 Conference was the formulation of recommendations related to standards and training programs for school bus drivers. These recommendations were revised by the 1959 Conference, and a new publication on the topic was issued. The 1954 Conference gave considerable time to the discussion of the extended use of school buses in the school program. The 1970 Conference also adopted standards for school bus operation (issued in a separate report).

The 1980 Conference updated the standards for school bus chassis and bodies, rewrote the complete standards for the specially equipped school bus, and included definitions for Types A, B, C and D buses. One of the major tasks of the 1980 Conference was to revise the standards to remove any conflicts with superseding federal regulations, many of which were mandated by sections of the Motor Vehicle and School Bus Safety Amendments of 1974 (Public Law 93-492).

The 1985 Conference updated the standards for school bus chassis, bodies, special education and operations procedures. A major project was completed in the adoption of a uniform school bus accident reporting form. This form was designed to standardize school bus accident data reporting throughout the school transportation industry. Major issues such as safety inside the vehicle, loading and unloading, emergency procedures and special education were discussed with appropriate resolutions passed for future research and implementation.

The 1990 Conference removed the word *minimum* from the title of the conference publication. The format of the conference publication was reorganized into two parts, Standards for School Buses and Standards for Operations. All sub-parts, such as accident reporting and special education transportation, were incorporated into the section on the school bus or the section on operations.

A major change was incorporated into the procedures for the 1990 Conference. Any mandatory standard could be recommended for a special vote for forwarding action to the appropriate federal agency with a request for rulemaking. This rulemaking request would be an attempt to have the standard adopted at the conference become a federally mandated requirement. For this forwarding action to be approved, any such item had to receive two-thirds affirmative vote. The delegation approved forwarding action on standards for mirrors, emergency exits, accident reporting and special education transportation. This procedural change was carried forward for the 1995 Conference.

The 1995 Conference was the first to begin to address the expanded role of student transportation as prescribed in the revised Highway Safety Program Guideline #17 - Pupil Transportation Safety. The revised guidelines became effective May 29, 1991, and this was the first conference convened since its adoption. Transportation of pre-kindergarten age students, including infants and toddlers, was addressed for the first time. A comprehensive section dealing with the use of alternative fuels in school bus operations was discussed and included in the publication. A new section, Terms and Definitions, was added to the appendices to promote consistency throughout the industry and consolidate into one resource the acronyms, abbreviations and standard terms used in the industry. It provided easy access to definitions of terms used or referenced within the document.

The 2000 Conference included significant discussion of the purpose and intended use of the document, which had been known in previous conferences as the "National Standards for School Transportation." Leading up to the 2000 Conference, arguments were made for retention in the title of the term *Standards* or adoption of the new term *Guidelines*. These deliberations were an attempt to accurately describe the document to state and local transportation providers, industry suppliers, governmental oversight agencies, representatives of the legal profession and other users. The new title approved by the delegates was the "National School Transportation Specifications and Procedures." A significant majority of the delegates believed that title described the actual contents and intended use of the document more precisely. The Introduction was expanded to explain clearly that the National School Transportation Specifications and Procedures comprises recommendations of the delegates to the states and other potential users of the document. It also clarified that these entities may choose, under their respective regulatory authorities, to adopt all or part of the specifications and procedures into laws or regulations.

Other significant changes or additions adopted by the 2000 Conference delegates included: a new side intrusion test for school bus bodies; a strong recommendation to states to require the use of school buses or buses having equivalent crash protection for all student transportation; reorganization of the operations sections into a more user-friendly format; sanctioning of the recent federal guidelines for seating of pre-school age students; conformance of the procedures for transportation of students with disabilities with updated federal regulations; and, a new section on school bus inspection.

In 2005 the delegates changed the name of the conference to the National Congress on School Transportation to describe more accurately the longstanding nature of the proceedings, involving deliberation and decision-making following parliamentary procedure. Significant changes or additions adopted by the 2005 Congress delegates included: a request to the School Bus Manufacturers Technical Council (SBMTC) to develop specifications for the fire-blocking performance of school bus chassis firewalls; clarification of the allowance for either black or yellow trim coloration on school bus bodies; augmentation of the recently updated Federal Motor Vehicle Safety Standard 217 emergency exit requirements to include additional roof hatches; accommodation

of the new Multifunction School Activity Bus sub-category of school buses; a recommendation to require “high-back” passenger seats in all large school buses as a further improvement to school bus passenger crash protection; a recommendation to require noise canceling switches for use by school bus operators during railroad crossings; a recommendation, based on research findings, to prohibit the installation of two-point lap belts in large school buses, except to secure child safety restraint systems; elimination of requirements that were duplicative of recent federal and Society of Automotive Engineers (SAE) standards for specially equipped school buses; new operational procedures calling for reduced school bus engine idling, use of two-way communications systems, and required post-trip checks of buses by drivers for unattended children; addition of new sections on School Transportation Security and School Activity Transportation; and, updating of the sections on Transportation for Students with Disabilities and Special Health Care Needs, and Infants, Toddlers, and Pre-school Children to conform to recent federal reauthorizations.

On a sad note, the Congress Steering Committee and the New Jersey delegation lost one of their own on May 19, 2005. Dennis Hammell died during the congress of an apparent heart attack. Mr. Hammell, president of the Lafayette, New Jersey-based Village Bus Company, had recently sold the company to First Student, Inc. A board member of the National School Transportation Association (NSTA), he also represented NSTA on the NCST Steering Committee through three congresses. He was the Chief of the Sparta Township Fire Department and was active in music education in his community and through the Rowan University Foundation. The congress will miss Dennis’s friendship and his spirited contributions to the important work of the congresses.

With the enactment in 1966 of the National Traffic and Motor Vehicle Safety Act, the federal government was given responsibility for developing and promulgating motor vehicle safety standards for motor vehicles sold in the United States. These Federal Motor Vehicle Safety Standards (FMVSS) are continually evaluated and revised, as needed. Such standards in their present form, or as subsequently amended, will void any action taken during the 2005 Congress wherever there is a conflict. Whenever specifications and procedures adopted by the 2005 Congress go beyond, or are in addition to the FMVSS, they remain valid.

The structure for the 2005 Congress and its operating guidelines were carried out by the Steering Committee. Funding for the congress was shared solely by each individual participant of the Steering Committee, the writing committees and all delegates at the congress.

Charles F. Hood

General Congress Chairperson

## **ABOUT THIS DOCUMENT**

Certain objectives and guiding principles have a vital role in the development of the specifications for school buses and procedures for their operation. These objectives and guiding principles have been reaffirmed and emphasized at the National Congresses (formerly Conferences) since 1939. The major objectives, safety, security and efficiency, along with the guiding principles stated herein, have served as guideposts for making decisions regarding the specifications and procedures and in arriving at sound and common agreement.

Adequate state and federal regulations governing school bus specifications and operation provide the key ingredients for the safe, secure and efficient transportation of students. Safety and security include all factors relating to school bus equipment, performance specifications and operational procedures that may directly or indirectly affect the safety, security and welfare of students transported. Efficiency includes the management of specifications, procurement and maintenance of school buses, the operational practices and procedures of staff consistent with the safety and welfare of students and the effective use of financial resources.

### **GUIDING PRINCIPLES**

A. Federal standards and state specifications for school buses and procedures for their operation should:

1. Be consistent with the objectives of safety, security and efficiency;
2. Ensure the construction and use of safe buses;
3. Reduce conflicting specifications and procedures among states, wherever possible; and
4. Specify exact dimensions, where necessary, to increase the quality and efficiency of manufacture.

B. Any adaptation of these national specifications and procedures should be made by states only in order to adjust to local needs and only when such adaptations do not:

1. Conflict with Federal Motor Vehicle Safety Standards (FMVSS);
2. Conflict with the National Highway Traffic Safety Administration's Highway Safety Guideline #17 - Pupil Transportation Safety; and
3. Unduly increase operation or production costs.

C. State specifications for school buses and operational procedures should be written in terms of the performance desired, thus assuring that the resulting state regulations are enforceable.

D. Provisions should be made within each state for periodic review and revision of its specifications for school buses and procedures for their operation.

E. State specifications for school buses and procedures for their operation should allow for state approval of the use of new inventions and improvements that are consistent with safety, security and efficiency.

F. State specifications for school buses should provide for a degree of flexibility (consistent with safety, security and efficiency) to accommodate the various manufacturers.

G. State specifications for school buses should recognize that the actual design of school buses is a responsibility of the manufacturers.

H. The current National School Transportation Specifications and Procedures comprises recommendations to the states. Revisions of these specifications and procedures are made only when evidence indicates that such revisions are needed.

## **INTENDED USE**

These specifications for school buses and procedures for operation are available for states to consider when establishing their standards, specifications, recommendations and guidelines. As a general rule, state legislatures should confer upon the appropriate state agency or regulatory body the general responsibility for setting up state-wide rules and regulations regarding the specifications for school bus chassis, bodies and equipment and the procedures for school transportation operations.

The specifications and procedures for school transportation appearing in this report represent the official actions of the delegates to the 14th National Congress on School Transportation and comprise recommendations to regulatory authorities or other parties. Except for restatements of federal standards, laws and rules that may be contained herein, these recommendations are not regulatory until they are officially adopted by the appropriate state regulatory authority to become legally effective within that state. It should be noted that some items in this report are informational only and do not constitute “recommendations” of the delegates.

In considering these specifications and procedures for adoption into state regulations, each portion or individual content item should be reviewed by the state to determine its applicability, as recommended by the delegates. The following terms are used throughout this document to define the recommended applicability within states adopting these specifications and procedures:

A. *SHALL* - a mandatory condition. Where certain school bus designs, equipment or operations are described with the *shall* stipulation, it is mandatory that all school buses and all school bus operations meet those requirements, as written.

Note: The word *shall* also is used when referring to items that are already adopted into federal laws, standards or regulations.

B. *SHOULD* - an advisory condition. Where certain school bus designs, equipment or operations are described with the word *should*, such items are considered to be advisable usage. In other words, the item is recommended, but not mandatory, for all school buses or all school bus operations.

C. *MAY* - a permissive condition. Where certain school bus designs, equipment or operations are described with the word *may*, such items are considered for possible

usage. However, there is no intent that the item be required for all school buses or all school bus operations.

Recognizing that many of these specifications and procedures (those using the above definition of *shall*) are recommended as requirements and will become requirements when they are adopted into regulations by individual states, the principles and guidelines for the intended use of this report are consistent with the following “Statement of Understanding” adopted by the Steering Committee of the National Congress on School Transportation (for inclusion herein). In the context of this overall report, the following statement reminds persons using the report that until these specifications and procedures are adopted into state regulations, either by reference or directly, adherence to their provisions is voluntary:

The purpose of this publication is to serve as a basis for the separate states to establish specifications, rules and/or regulations for school transportation within those states. This publication is representative of the consensus of professional practitioners from the states represented at the National Congress on School Transportation. Its emphasis on practices, procedures and performance encompasses school transportation in total and includes guidelines for school buses and school bus operations. The material contained herein will provide useful guidance for school transportation specialists in each state; however, it does not establish specifications or standards for any state. Use of this publication in part or in its entirety is completely voluntary.

The vehicle specifications contained herein are intended to apply primarily to new vehicles, including all types of school buses, as defined in the section entitled “Definitions, School Bus (Type A-1, Type A-2, Type B-1, Type B-2, Type C and Type D).” It should be noted that vehicles with a capacity of ten (10) or fewer persons, including the driver, cannot be certified as school buses under federal regulations.

States should allow sufficient lead time between publication of their specifications and the effective date. The effective date should be expressed: “These specifications apply respectively to school bus chassis and bodies placed in production on or after (month, day, year).”

## **INTERPRETATIONS AND INFORMATION**

Requests for interpretation of these specifications and procedures should be mailed to the chairman of the Interpretations Committee, addressed as follows: Charles F. Hood, Florida Department of Education, 325 West Gaines Street, Suite 1134, Tallahassee, Florida 32399-0400. Complete information on the National Congress on School Transportation is available at [www.NCSTOnline.org](http://www.NCSTOnline.org). Interested parties are encouraged to visit the website for the most current information on all aspects of the 2005 14<sup>th</sup> NCST, the next NCST, and for any published interpretations to these National School Transportation Specifications and Procedures.

## **INTERIM COMMITTEE**

The Interim Committee succeeds the Congress Steering Committee between congresses. Requests for modifications of the specifications and procedures and development of new ones should be directed to the chairman of the Interim Committee, addressed as follows: Mr. Pete Baxter, Director, Division of School Traffic Safety and Emergency Planning, Indiana Department of Education, Room 229 State House, Indianapolis, Indiana 46204-2798.

# SCHOOL BUS TYPES

**Type A:** A Type A school bus is a conversion bus constructed utilizing a cutaway front section vehicle with a left side driver's door. This definition includes two classifications: Type A-1, with a Gross Vehicle Weight Rating (GVWR) of 14,500 pounds or less; and Type A-2, with a GVWR greater than 14,500 pounds and less than or equal to 21,500 pounds.



Type A-1

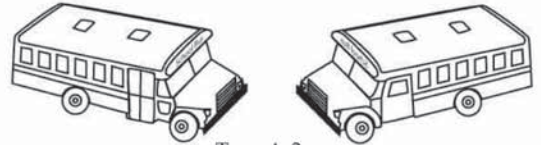

Type A-2

**Type B:** A Type B school bus is constructed utilizing a stripped chassis. The entrance door is behind the front wheels. This definition includes two classifications: Type B-1, with a GVWR of 10,000 pounds or less, and Type B-2, with a GVWR greater than 10,000 pounds.

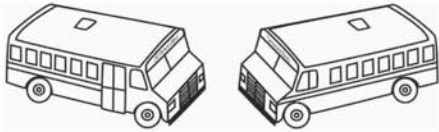

Type B

**Type C:** A Type C school bus is constructed utilizing a chassis with a hood and front fender assembly. The entrance door is behind the front wheels—also known as a conventional style school bus. This type also includes the cutaway truck chassis or truck chassis with cab with or without a left side door and with a GVWR greater than 21,500 pounds.

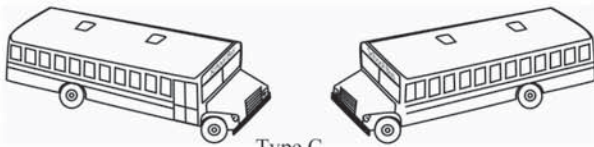

Type C  
Conventional

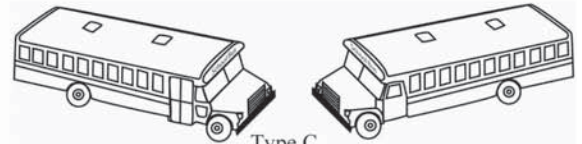

Type C  
Cutaway

**Type D:** A Type D school bus is constructed utilizing a stripped chassis. The entrance door is ahead of the front wheels—also known as a rear engine or front engine transit style school bus.

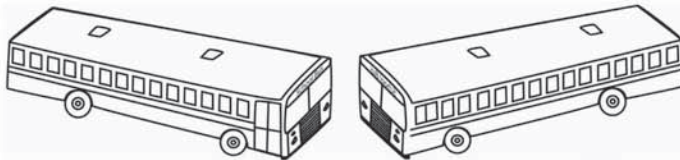

Type D

## INTRODUCTION TO SCHOOL BUS SPECIFICATIONS

This portion of the report is divided into four sections: Chassis Specifications, Body Specifications, Specifications for Specially Equipped School Buses and Specifications for Alternative Fuel School Buses. If these specifications are adopted by a state or states, special attention must be given to them by the chassis and the body manufacturer, as appropriate or necessary.

Every attempt has been made by the Writing Committees, the Congress itself and the Editing Committee to eliminate conflicts between these specifications and federal regulations. Should conflicts be found to exist or arise through new federal regulations or legally binding interpretations of those regulations, they should be brought to the attention of the Interpretations Committee, who, in turn, will report them to the Interim Committee.

For new vehicles, it is the responsibility of the vehicle manufacturer to certify compliance with applicable federal standards by installing a certification plate or label in the driver's area on each vehicle. However, as the vehicle is maintained over its useful life, it is the responsibility of those who supervise and perform work on the vehicle to assure ongoing compliance with all applicable federal and state standards and specifications, as well to coordinate recalls. For this reason, maintenance personnel training, quality components, quality workmanship and thorough maintenance records are essential.

Finally, in order to ensure that specifications are being met by manufacturers, states are urged to adopt and carry out effective pre-delivery inspection programs.



# **BUS CHASSIS SPECIFICATIONS**



## BUS CHASSIS SPECIFICATIONS

### AIR CLEANER

- A. A dry element air cleaner shall be provided.
- B. All diesel engine air filters shall include a latch-type restriction indicator that retains the maximum restriction developed during operation of the engine. The indicator should include a reset control so the indicator can be returned to zero when desired.

### AXLES

The front and rear axle and suspension systems shall have a gross axle weight rating (GAWR) at ground commensurate with the respective front and rear weight loads of the bus loaded to the rated passenger capacity.

### BRAKES: GENERAL

- A. The chassis brake system shall conform to the provisions of FMVSS Nos. 105, *Hydraulic and Electric Brake Systems*, 106, *Brake Hoses*, and 121, *Air Brake Systems*, as applicable.
- B. The anti-lock brake system (ABS), provided in accordance with FMVSS No. 105, *Hydraulic and Electric Brake Systems* or No. 121, *Air Brake Systems*, shall provide wheel speed sensors for each front wheel and for each wheel on at least one rear axle. The system shall provide anti-lock braking performance for each wheel equipped with sensors (Four Channel System).
- C. All brake systems shall be designed to permit visual inspection of brake lining wear without removal of any chassis component(s).
- D. The brake lines, booster-assist lines, and control cables shall be protected from excessive heat, vibration and corrosion and installed in a manner that prevents chafing.
- E. The parking brake system for either air or hydraulic service brake systems may be of a power-assisted design. The power parking brake actuator should be a device located on the instrument panel within reach of seated a 5th percentile female driver. As an option, the parking brake may be set by placing the automatic transmission shift control mechanism in the “park” position.
- F. The power-operated parking brake system may be interlocked to the engine key switch. Once the parking brake has been set and the ignition switch turned to the “off” position, the parking brake cannot be released until the key switch is turned back to the “on” position.

## **BRAKES: HYDRAULIC**

Buses using a hydraulic-assist brake shall be equipped with audible and visible warning signals that provide a continuous warning to the driver indicating a loss of fluid flow from the primary source or a failure of the back-up pump system.

## **BRAKES: AIR**

- A. The air pressure supply system shall include a desiccant-type air dryer installed according to the manufacturer's recommendations. The air pressure storage tank system may incorporate an automatic drain valve.
- B. The chassis manufacturer shall provide an accessory outlet for air-operated systems installed by the body manufacturer. This outlet shall include a pressure protection valve to prevent loss of air pressure in the service brake reservoir.
- C. For air brake systems, an air pressure gauge shall be provided in the instrument panel capable of complying with Commercial Driver's License (CDL) pre-trip inspection requirements.
- D. Air brake-equipped buses may be equipped with a service brake interlock. If equipped with a service brake interlock, the parking brake cannot be released until the brake pedal is depressed.
- E. Air brake systems shall include a system for anti-compounding of the service brakes and parking brakes.
- F. Air brakes shall have both a visible and audible warning device whenever the air pressure falls below the level where warnings are required under FMVSS No. 121, *Air Brake Systems*.

## **BUMPER: FRONT**

- A. School buses shall be equipped with a front bumper. The front bumper shall be furnished by the chassis manufacturer for all school bus types unless there is a specific alternate agreement between the chassis manufacturer and body manufacturer.
- B. The front bumper on buses of Type A-2 (with GVWR greater than 14,500 pounds), Type B, Type C, and Type D shall be equivalent in strength and durability to pressed steel channel at least 3/16 inches thick and not less than 8 inches wide (high). It shall extend beyond the forward-most part of the body, grille, hood and fenders and shall extend to the outer edges of the fenders at the bumper's top line.

Type A buses having a GVWR of 14,500 pounds or less may be equipped with an OEM-supplied front bumper. The front bumper shall be of sufficient strength to permit being pushed by another vehicle on a smooth surface with a 5 degree, (8.7 percent) grade, without permanent distortion. The contact point on the front bumper is intended to be between the frame rails, with as wide a contact area as possible. If the front bumper is used for lifting, the contact points shall be under the bumper attachments to the frame rail brackets unless the manufacturer specifies different lifting points in the owner's manual. Contact and lifting pressures should be applied simultaneously at both lifting points.

- C. The front bumper, except breakaway bumper ends, shall be of sufficient strength to permit pushing a vehicle of equal gross vehicle weight, per Section B, without permanent distortion to the bumper, chassis or body.
- D. Tow eyes or hooks shall be furnished and attached so they do not project beyond the front bumper. Tow eyes or hooks attached to the chassis frame shall be furnished by the chassis manufacturer. This installation shall be in accordance with the chassis manufacturer's specifications. Tow hooks or eyes shall have an individual strength rating of 13,500 pounds each, for a combined rating of 27,000 pounds. For pulling and lifting purposes, tow hooks are meant to be used simultaneously. For pulling, angularity applied to the tow hooks will decrease the capacities of the tow hooks.

**Note:** Type A buses are exempt from this requirement for front tow hooks or eyes due to built-in crush zones. Rear tow eyes or hooks are addressed in BUS BODY SPECIFICATIONS under Towing Attachment Points.

- E. The bumper shall be designed or reinforced so that it will not deform when the bus is lifted by a chain that is passed under the bumper (or through the bumper if holes are provided for this purpose) and attached to both tow hooks/eyes. For the purpose of meeting this specification, the bus shall be empty and positioned on a level, hard surface and both tow hooks/eyes shall share the load equally.

## **CERTIFICATION**

Upon request of the state agency having student transportation jurisdiction, the chassis manufacturer shall certify that its product meets the state's minimum standards on items not covered by the FMVSS certification requirements of 49 CFR, Part 567.

## **CLUTCH**

- A. Clutch torque capacity shall be equal to or greater than the engine torque output.
- B. A starter interlock shall be installed to prevent actuation of the starter if the clutch pedal is not depressed.

## **COLOR**

- A. The chassis, including wheels and front bumper, shall be black. Body, cowl, hood and fenders shall be in National School Bus Yellow (NSBY). The flat top surface of the hood may be non-reflective black or NSBY. (See APPENDIX B.)
- B. If used, demountable rims may be silver, gray, white, yellow or black, (as received from the wheel manufacturer).
- C. Multi-Function School Activity Buses (MFSABs) shall be exempt from these requirements.

## **DRIVE SHAFT**

The drive shaft shall be protected by a metal guard or guards around the circumference of the drive shaft to reduce the possibility of its whipping through the floor or dropping to the ground, if broken.

## **ELECTRICAL SYSTEM**

- A. Battery
  - 1. The storage batteries shall have minimum cold cranking capacity rating (cold cranking amps) equal to the cranking current required for 30 seconds at 0 degrees Fahrenheit and a minimum reserve capacity rating of 120 minutes at 25 amps. Higher capacities may be required, depending upon optional equipment and local environmental conditions.
  - 2. Since all batteries are to be secured in a sliding tray in the body, chassis manufacturers shall mount the battery temporarily on the chassis frame, except that van conversion or cutaway front-section chassis may be secured in accordance with the manufacturer's standard configuration. In these cases, the final location of the battery and the appropriate cable lengths shall be agreed upon mutually by the chassis and body manufacturers. However, in all cases the battery cable provided with the chassis shall have sufficient length to allow some slack, and be of sufficient gauge to carry the required amperage.
- B. Alternator
  - 1. All Type A-2 and Type B buses with a GVWR of 15,000 pounds or less shall have a minimum 130-amp alternator.
  - 2. Type A-2 and Type B buses over 15,000 pounds GVWR and all Type C and Type D buses shall be equipped with a heavy-duty truck or bus-type alternator meeting SAE J180, *Electrical Charging Systems for Construction and Industrial Machinery*, having a minimum output rating

of 130 amps or higher, and should produce a minimum current output of 50 percent of the rating at engine idle speed.

3. Buses equipped with an electrically powered wheelchair lift, air conditioning or other accessories may be equipped with a device that monitors the electrical system voltage and advances the engine idle speed when the voltage drops to, or below, a pre-set level.
4. A belt driven alternator shall be capable of handling the rated capacity of the alternator with no detrimental effect on any other driven components. (For estimating required alternator capacity, see School Bus Manufacturers Technical Council's publication, "School Bus Technical Reference," available at <http://www.nasdpts.org>.)
5. A direct-drive alternator is permissible in lieu of a belt-driven alternator.

C. Electrical Components

1. Materials in all electrical components shall contain no mercury.

D. Wiring

1. All wiring shall conform to current applicable recommended practices of the Society of Automotive Engineers (SAE). All wiring shall use color and at least one other method for identification. The other method shall be either a number code or name code, and each chassis shall be delivered with a wiring diagram that illustrates the wiring of the chassis.
2. The chassis manufacturer of an incomplete vehicle shall install a readily accessible terminal strip or connector on the body side of the cowl or in an accessible location in the engine compartment of vehicles designed without a cowl. The strip or connector shall contain the following terminals for the body connections:
  - a. Main 100-amp body circuit;
  - b. Tail lamps;
  - c. Right turn signal;
  - d. Left turn signal;
  - e. Stop lamps;
  - f. Back-up lamps; and
  - g. Instrument panel lamps (rheostat controlled by headlamp switch).

- E. Circuits
  - 1. An appropriate identifying diagram (color plus a name or number code) for all chassis electrical circuits shall be provided to the body manufacturer for distribution to the end user.
  - 2. Wiring for the headlamp system must be separate from the electronic controlled body solenoid/module.

F. Daytime Running Lamps (DRL)

A daytime running lamps system shall be provided.

### **ENGINE FIRE EXTINGUISHER**

The chassis manufacturer may provide an automatic fire extinguisher system in the engine compartment.

### **EXHAUST SYSTEM**

- A. The exhaust pipe, muffler and tailpipe shall be outside the bus body compartment and shall be attached to the chassis so any other chassis component is not damaged.
- B. The tailpipe shall be constructed of a corrosion-resistant tubing material at least equal in strength and durability to 16-gauge steel tubing of equal diameter.
- C. Chassis manufacturers shall furnish an exhaust system with a tailpipe of sufficient length to exit at the rear of the bus or at the left side of the bus body no more than 18 inches forward of the front edge of the rear wheel house opening. If designed to exit at the rear of the bus, the tailpipe shall extend at least five inches beyond the end of the chassis frame. If designed to exit at the side of the bus, the tailpipe shall extend at least 48.5 inches (51.5 inches if the body is to be 102 inches wide) outboard from the chassis centerline.
  - 1. On Types C and D vehicles, the tailpipe shall not exit beneath a fuel fill or emergency door exit.
  - 2. Types A and B chassis may be furnished with the manufacturer's standard tailpipe configuration. (See also BUS BODY SPECIFICATIONS: Tailpipe.)
- D. The exhaust system on a chassis shall be adequately insulated from the fuel system.
- E. The muffler shall be constructed of corrosion-resistant material.



## **FENDERS: FRONT TYPE C VEHICLES**

- A. When measured at the fender line, the total spread of the outer edges of front fenders shall exceed the total spread of front tires when front wheels are in a straight-ahead position.
- B. Front fenders shall be properly braced and shall not require attachment to any part of the body.

## **FRAME**

- A. Frame lengths shall be established in accordance with the design criteria for the complete vehicle.
- B. Making holes in top or bottom flanges or side units of the frame and welding to the frame shall not be permitted except as provided or accepted by the chassis manufacturer.
- C. Frames shall not be modified for the purpose of extending the wheel base.
- D. Any secondary manufacturer that modifies the original chassis frame shall provide a warranty at least equal to the warranty offered by the original equipment manufacturer (OEM), and shall certify that the modification and other parts or equipment affected by the modification shall be free from defects in material and workmanship under normal use and service intended by the OEM.

## **FUEL SYSTEM**

- A. Fuel tank(s) having a minimum 30-gallon capacity shall be provided by the chassis manufacturer. Each tank shall be filled from and vented to the outside of the passenger compartment, and each fuel filler should be placed in a location where accidental fuel spillage will not drip or drain on any part of the exhaust system.
- B. The fuel system shall comply with FMVSS No. 301, *Fuel System Integrity*.
- C. Fuel tank(s) may be mounted between the chassis frame rails or outboard of the frame rails on either the left or right side of the vehicle.
- D. The actual draw capacity of each fuel tank shall be a minimum of 83 percent of the tank capacity.
- E. Installation of alternative fuel systems, including fuel tanks and piping from the tank to the engine, shall comply with all applicable fire codes in effect on the date of manufacture of the bus.

- F. Installation of Liquefied Petroleum Gas (LPG) tanks shall comply with National Fire Protection Association (NFPA) 58, *Liquefied Petroleum Gas Code*.
- G. Installation of Compressed Natural Gas (CNG) containers shall comply with FMVSS No. 304, *Compressed Natural Gas Fuel Container Integrity*.
- H. The CNG Fuel System shall comply with FMVSS No. 303, *Fuel System Integrity of Compressed Natural Gas Vehicles*.

## **GOVERNOR**

An electronic engine speed limiter shall be provided and set to limit engine speed, not to exceed the maximum revolutions per minute, as recommended by the engine manufacturer.

## **HEATING SYSTEM, PROVISION FOR**

The chassis engine shall have plugged openings for the purpose of supplying hot water for the bus heating system. The openings shall be suitable for attaching  $\frac{3}{4}$  inch pipe thread/hose connectors. The engine shall be capable of supplying coolant at a temperature of at least 170 degrees Fahrenheit at the engine coolant thermostat opening. The coolant flow rate shall be 50 pounds per minute at the return end of 30 feet of 1 inch inside diameter automotive hot water heater hose. (See SBMTC-001, *Standard Code for Testing and Rating Automotive Bus Hot Water Heating and Ventilating Equipment*.)

## **HORN**

The bus shall be equipped with a horn(s) of standard make with the horn(s) capable of producing a complex sound in bands of audio frequencies between 250 and 2,000 cycles per second, and tested in accordance with SAE J377, *Horn—Forward Warning—Electric—Performance, Test, and Application*.

## **INSTRUMENTS AND INSTRUMENT PANEL**

- A. The chassis shall be equipped with the instruments and gauges listed below: (Telltale warning lamps in lieu of gauges are not acceptable, except as noted.)
  - 1. Speedometer;
  - 2. Odometer which will give accrued mileage (to seven digits), including tenths of miles, unless tenths of miles are registered on a trip odometer. Odometer is to be able to be read without using a key;

3. Tachometer (**Note:** For types B, C and D buses, a tachometer shall be installed so as to be visible to the driver while seated in a normal driving position.);
  4. Voltmeter (**Note:** An ammeter with graduated charge and discharge indications is permitted in lieu of a voltmeter; however, when used, the ammeter wiring must be compatible with the current flow of the system.);
  5. Oil pressure gauge;
  6. Water temperature gauge;
  7. Fuel gauge;
  8. Upper beam headlamp indicator;
  9. Brake air pressure gauge (air brakes), brake indicator lamp (vacuum/hydraulic brakes), or brake indicator lamp (hydraulic/hydraulic);
  10. Turn signal indicator; and
  11. Glow-plug indicator lamp, where appropriate.
- B. All instruments shall be easily accessible for maintenance and repair.
- C. The instruments and gauges shall be mounted on the instrument panel so that each is clearly visible to the driver while seated in a normal driving position.
- D. Instruments and controls must be illuminated as required by FMVSS No. 101, *Controls and Displays*.
- E. Multi-function gauge (MFG)
1. The driver must be able to manually select any displayable function of the gauge on a MFG, whenever desired.
  2. Whenever an out-of-limits condition that would be displayed on one or more functions of a MFG occurs, the MFG controller should automatically display this condition on the instrument cluster. This should be in the form of an illuminated telltale warning lamp, as well as having the MFG automatically display the out-of-limits indications. If two or more functions displayed on the MFG go out of limits simultaneously, then the MFG should sequence automatically between those functions continuously until the condition(s) are corrected.

3. The use of a MFG does not relieve the need for audible warning devices, where required.

### **OIL FILTER**

An oil filter with a replaceable element shall be provided and connected by flexible oil lines if it is not a built-in or an engine-mounted design. The oil filter shall have a capacity in accordance with the engine manufacturer's recommendation.

### **OPENINGS**

All openings in the floorboard or firewall between the chassis and the passenger compartment (e.g., for gearshift selector and parking brakes lever) shall be sealed.

### **PASSENGER LOAD**

- A. Actual gross vehicle weight (GVW) is the sum of the chassis weight plus the body weight, plus the driver's weight, plus total seated student weight. For purposes of calculation, the driver's weight is 150 pounds and the student weight is 120 pounds per student.
- B. Actual GVW shall not exceed the chassis manufacturer's GVWR for the chassis, nor shall the actual weight carried on any axle exceed the chassis manufacturer's Gross Axle Weight Rating (GAWR).
- C. The manufacturer's GVWR for a particular school bus shall be furnished by manufacturers in duplicate (unless more copies are requested) to the state agency having student transportation jurisdiction. The state agency shall, in turn, transmit such ratings to other state agencies responsible for development or enforcement of state standards for school buses.

### **RETARDER SYSTEM (OPTIONAL EQUIPMENT)**

A retarder system, if used, shall limit the speed of a fully loaded school bus to 19.0 mph on a 7 percent grade for 3.6 miles.

### **ROAD SPEED CONTROL**

When it is desired to accurately control vehicle maximum speed, a vehicle speed limiter may be utilized.

### **SHOCK ABSORBERS**

The bus shall be equipped with double-action shock absorbers compatible with the manufacturer's rated axle capacity at each wheel location.

## **STEERING GEAR**

- A. The steering gear shall be approved by the chassis manufacturer and designed to ensure safe and accurate performance when the vehicle is operated with maximum load and at maximum speed.
- B. If external adjustments are required, the steering mechanism shall be accessible to make adjustments.
- C. Changes shall not be made to the steering apparatus which are not approved by the chassis manufacturer.
- D. There shall be a clearance of at least 2 inches between the steering wheel and cowl, instrument panel, windshield or any other surface.
- E. Power steering is required and shall be of the integral type with integral valves.
- F. The steering system shall be designed to provide a means for lubrication of all wear-points that are not permanently lubricated.

## **SUSPENSION SYSTEMS**

- A. The capacity of springs or suspension assemblies shall be commensurate with the chassis manufacturer's GVWR .
- B. Rear leaf springs shall be of a progressive rate or multi-stage design. Front leaf springs shall have a stationary eye at one end and shall be protected by a wrapped leaf, in addition to the main leaf.

## **THROTTLE**

The force required to operate the throttle shall not exceed 16 pounds throughout the full range of accelerator pedal travel.

## **TIRES AND RIMS**

- A. Rims and tires of the proper size and load rating commensurate with the chassis manufacturer's GVWR shall be provided. The use of multi-piece rims and/or tube-type tires shall not be permitted on any school bus ordered after December 31, 1995.
- B. Dual rear tires shall be provided on Type A-2, Type B, Type C and Type D school buses.
- C. All tires on a vehicle shall be of the same size, and the load range of the tires shall meet or exceed the GVWR, as required by FMVSS No. 120, *Tire Selection and Rims for Vehicles other than Passenger Car*.

- D. If the vehicle is equipped with a spare tire and rim assembly, it shall be the same size as those mounted on the vehicle.
- E. If a tire carrier is required, it shall be suitably mounted in an accessible location outside of the passenger compartment.

## **TRANSMISSION**

- A. Automatic transmissions shall have no fewer than three forward speeds and one reverse speed. Mechanical shift selectors shall provide a detent between each gear position when the gear selector quadrant and shift selector are not steering-column mounted.
- B. In manual transmissions, second gear and higher shall be synchronized, except when incompatible with engine power. A minimum of three forward speeds and one reverse speed shall be provided.
- C. A transmission interlock, controlled by application of the service brake, shall be installed to prohibit accidental engagement of the automatic transmission.

## **TURNING RADIUS**

- A. A chassis with a wheelbase of 264 inches or less shall have a right and left turning radius of not more than 42 ½ feet, curb-to-curb measurement.
- B. A chassis with a wheelbase of 265 inches or more shall have a right and left turning radius of not more than 44 ½ feet, curb-to-curb measurement.

## **UNDERCOATING**

The chassis manufacturers, or their agents, shall coat the undersides of steel or metallic-constructed front fenders with a rust-proofing compound, for which the compound manufacturer has issued notarized certification of compliance to chassis builder that the compound meets or exceeds all performance and qualitative requirements of paragraph 3.4 of Federal Specification TT-C-520B, *Coating Compound, Bituminous, Solvent Type, Underbody*, using modified tests.

# **BUS BODY SPECIFICATIONS**





## **BUS BODY SPECIFICATIONS**

### **AISLE**

- A. All emergency exit doors shall be accessible by a 12 inch minimum aisle. The aisle shall be unobstructed at all times by any type of barrier, seat, wheelchair or tiedown, unless a flip seat is installed and occupied. The track of a track seating system is exempt from this requirement. A flip seat in the unoccupied (up) position shall not obstruct the 12 inch minimum aisle to any side emergency exit door.
- B. The seat backs shall be slanted sufficiently to give aisle clearance of 15 inches at tops of seat backs.

### **BACK-UP WARNING ALARM**

An automatic audible alarm shall be installed behind the rear axle and shall comply with the published Backup Alarm Standards (SAE J994b), providing a minimum of 112 dBA, or shall have a variable volume feature that allows the alarm to vary from 87 dBA to 112 dBA sound level, staying at least 5 dBA above the ambient noise level.

### **BATTERY**

- A. The battery is to be furnished by the chassis manufacturer.
- B. When the battery(ies) is mounted as described in BUS CHASSIS SPECIFICATIONS, the body manufacturer shall securely attach the battery on a slide-out or swing-out tray in a closed, vented compartment in the body skirt so that the battery is accessible for convenient servicing from the outside. When in the stored position, the tray shall be retained by a securing mechanism capable of holding the tray [with battery (ies)] in position when subjected to a 5g load from any direction. The battery compartment door or cover if separate from the tray shall be hinged at the front or top and shall be secured by a positive an adequate and conveniently operated latching system or other type fastener., or the door may be an integral part of the battery slide tray. The door or cover must fit tightly to the body, and not present sharp edges or snagging points. Battery cables installed or replaced by the body manufacturer shall meet chassis manufacturer and SAE requirements. Battery cables shall be of sufficient length to allow the battery tray to fully extend. The battery compartment is required on Type A-1 diesel buses, and any battery(ies) mounted on the frame by the chassis manufacturer shall be relocated to the battery compartment.
- C. Buses may be equipped with a battery shut-off switch. The switch is to be placed in a location not readily accessible to the driver or passengers.

### **BUMPER: FRONT**

If the chassis manufacturer does not provide a bumper on a Type D school bus, the bumper shall be provided by the body manufacturer. The bumper shall conform to the specifications described in BUS CHASSIS SPECIFICATIONS.

### **BUMPER: REAR**

- A. The bumper on Type A-1 buses shall be a minimum of 8 inches wide (high). Bumpers on Types A-2, B, C and D buses shall be a minimum of 9½ inches wide

(high). The bumper shall be of sufficient strength to permit being pushed by another vehicle of similar size and being lifted by the bumper without permanent distortion.

- B. The bumper shall wrap around the back corners of the bus. It shall extend forward at least 12 inches, measured from the rear-most point of the body at the floor line, and shall be mounted flush with the sides of the body or protected with an end panel.
- C. The bumper shall be attached to the chassis frame in such a manner that it may be removed. It shall be braced to resist deformation of the bumper resulting from impact from the rear or the side. It shall be designed to discourage hitching of rides by an individual.
- D. The bumper shall extend at least 1 inch beyond the rear-most part of the body surface, measured at the floor line.
- E. The bottom of the rear bumper shall not be more than 30 inches above ground level.

## **CEILING**

(See BUS BODY SPECIFICATIONS, Insulation and Interior.)

## **CERTIFICATION**

Upon request of the state agency having student transportation jurisdiction, the body manufacturer shall certify that its product meets the state's minimum standards on items which are not covered by FMVSS certification requirements of 49 CFR, Part 567, *Certification*.

## **CHAINS (TIRE)**

(See BUS BODY SPECIFICATIONS, Wheelhousing.)

## **COLOR**

- A. The school bus body shall be painted National School Bus Yellow (NSBY). (See APPENDIX B.)
- B. The body exterior paint trim, as defined by individual states, shall be black or NSBY.
- C. Except for the vertical portion of the front and rear roof caps, the roof of the bus may be painted white. (See illustration in APPENDIX B, Placement of Retroreflective Markings.)
- D. MFSABs shall be exempt from these color requirements.

## **COMMUNICATIONS SYSTEMS**

(See OPERATIONS.)

## CONSTRUCTION

- A. Side Intrusion Test: The bus body shall be constructed to withstand an intrusion force equal to the curb weight of the vehicle or 20,000 pounds, whichever is less. Each vehicle shall be capable of meeting this requirement when tested in accordance with the procedures set forth below. The complete body structure, or a representative seven-body section mock up with seats installed, shall be load-tested at a location  $24\pm 2$  inches above the floor line, with a maximum 10 inch diameter cylinder, 48 inches long, mounted in a horizontal plane.

The cylinder shall be placed as close as practical to the mid-point of the tested structure, spanning two internal vertical structural members. The cylinder shall be statically loaded to the required force of curb weight or 20,000 pounds, whichever is less, in a horizontal plane with the load applied from the exterior toward the interior of the test structure. When the minimum load has been applied, the penetration of the loading cylinder into the passenger compartment shall not exceed 10 inches from its original point of contact. There can be no separation of lapped panels or construction joints. Punctures, tears or breaks in the external panels are acceptable but are not permitted on any adjacent interior panel. Body companies shall certify compliance with this intrusion requirement, and include test results, as requested.

- B. Construction shall be reasonably dust-proof and watertight.

## CROSSING CONTROL ARM

- A. School buses may be equipped with a crossing control arm mounted on the right side of the front bumper. When opened, this arm shall extend in a line parallel to the body side and aligned with the right front wheel.
- B. All components of the crossing control arm and all connections shall be weatherproofed.
- C. The crossing control arm shall incorporate system connectors (electrical, vacuum or air) at the gate and shall be easily removable to allow for towing of the bus.
- D. The crossing control arm shall be constructed of non-corrodible or nonferrous material, or treated in accordance with the body sheet metal specification. (See BUS BODY SPECIFICATIONS, Metal Treatment.)
- E. There shall be no sharp edges or projections that could cause injury or be a hazard to students. The end of the arm shall be rounded.
- F. The crossing control arm shall extend a minimum of 70 inches (measured from the bumper at the arm assembly attachment point) when in the extended position. The crossing control arm shall not extend past the end of the bumper when in the stowed position.
- G. The crossing control arm shall extend simultaneously with the stop signal arm(s), activated by stop signal arm controls.

- H. An automatic recycling interrupt switch may be installed for temporarily disabling the crossing control arm.
- I. The assembly shall include a device attached to the bumper near the end of the arm to automatically retain the arm while in the stowed position. That device shall not interfere with normal operations of the crossing control arm.

## DEFROSTERS

- A. Defrosting and defogging equipment shall direct a sufficient flow of heated air onto the windshield, the window to the left of the driver and the glass in the viewing area directly to the right of the driver to eliminate frost, fog and snow. (**Exception:** The requirements of this standard do not apply to the exterior surfaces of double pane storm windows.)
- B. The defrosting system shall conform to SAE J381, *Windshield Defrosting Systems Test Procedure and Performance Requirements—Trucks, Buses, and Multipurpose Vehicles*.
- C. The defroster and defogging system shall be capable of furnishing heated, outside ambient air, except that the part of the system furnishing additional air to the windshield, entrance door and stepwell may be the recirculating air type.
- D. Auxiliary fans are not considered defrosting or defogging systems.
- E. Portable heaters shall not be used.

## DOORS

- A. The entrance door shall be under the driver's control, designed to afford easy release and to provide a positive latching device on manual operating doors to prevent accidental opening. When a hand lever is used, no part shall come together that will shear or crush fingers. Manual door controls shall not require more than 25 pounds of force to operate at any point throughout the range of operation, as tested on a 10% grade, both uphill and downhill.
- B. The entrance door shall be located on the right side of the bus, opposite and within direct view of the driver.
- C. The entrance door shall have a minimum horizontal opening of 24 inches and a minimum vertical opening of 68 inches.
- D. The entrance door shall be a split-type door and shall open outward.
- E. All entrance door glass shall be approved safety glass. The bottom of each lower glass panel shall be not more than 10 inches from the top surface of the bottom step. The top of each upper glass panel when viewed from the interior shall be not more than 3 inches below the interior door control cover or header pad.

- F. Vertical closing edges on entrance doors shall be equipped with flexible material.
- G. All door openings shall be equipped with padding at the top edge of the opening. Padding shall be at least 3 inches wide and 1 inch thick and extend the full width of the door opening.
- H. On power-operated entrance doors, the emergency release valve, switch or device to release the entrance door must be placed above or to the immediate left or immediate right of the entrance door and must be clearly labeled.

## EMERGENCY EXITS

- A. Any installed emergency exit shall comply with the design and performance requirements of FMVSS No. 217, *Bus Emergency Exits and Window Retention and Release*, applicable to that type of exit, regardless of whether or not that exit is required by FMVSS No. 217.
- B. Emergency window requirements
  - 1. The rear emergency window shall have a lifting assistance device that will aid in lifting and holding the rear emergency window open.
  - 2. Side emergency exit windows, when installed, may be vertically hinged on the forward side of the window. No side emergency exit window will be located above a stop arm.
- C. Emergency door requirements
  - 1. The upper portion of the emergency door shall be equipped with approved safety glazing, the exposed area of which shall be at least 400 square inches. The lower portion of the rear emergency door on Types A-2, B, C and D vehicles shall be equipped with a minimum of 350 square inches of approved safety glazing.
  - 2. There shall be no steps leading to an emergency door except on Types C and D all-wheel drive buses.
  - 3. Padding shall be affixed to the top edge of each emergency door opening. Padding shall be at least 3 inches wide and 1 inch thick and shall extend the full width of the door opening.
  - 4. There shall be no obstruction higher than  $\frac{1}{4}$  inch across the bottom of any emergency door opening.
- D. Emergency exit requirements: The use of the following tables is to determine the REQUIRED number and types of emergency exits to comply with this specification, based on the bus manufacturer's equipped seating capacity.
  - 1. Use **Table 1** if the bus contains a Rear Emergency Door, or

2. Use **Table 2** if the bus contains a Rear Pushout Emergency Window AND a Left Side Emergency Door, as required by FMVSS No. 217 for school buses without a Rear Emergency Door.
3. When using either Table 1 or Table 2:
  - a. Enter the Table at the appropriate “CAPACITY” and select the desired row from the options for that capacity.
  - b. A school bus will meet the requirements of this specification and the requirements of FMVSS 217 if it contains the types and quantities of emergency exits listed on the row selected.

**TABLE 1**  
**BUSES WITH REAR EMERGENCY DOOR**  
 (All Front Engine Buses)

Available Combinations By Capacity	Manufacturers Equipped Capacity	Shall Have	And Shall Also Have		
		Roof Hatch	L. Side Emerg. Exit Windows	R. Side Emerg. Exit Windows	L. Side Emerg. Exit Door
1-45	1-45	1	0	0	0
46-70	46-70	2	1	1	0
	46-70	2	0	0	1
71-85	71-85	2	2	2	0
	71-85	2	0	0	1
86-93	86-93	2	2	2	0
	86-93	2	1	1	1

**TABLE 2**  
**BUSES WITH REAR PUSHOUT WINDOW**  
**AND LEFT SIDE EMERGENCY DOOR**  
 (All Rear Engine Buses)

Available Combinations By Capacity	Manufacturers Equipped Capacity	Shall Have	And Shall Also Have		
		Roof Hatch	L. Side Emerg. Exit Windows	R. Side Emerg. Exit Windows	L. Side Emerg. Exit Door
1-45	1-45	1	0	0	0
46-82	46-82	2	1	1	0
	46-82	2	0	0	1
83-89	83-89	2	1	1	0
	83-89	2	0	0	1
90-105	90-105	2	2	2	0
	90-105	2	1	1	1

**EMERGENCY EQUIPMENT**

- A. Fire extinguisher
  1. The bus shall be equipped with at least one UL-approved pressurized, dry chemical fire extinguisher. The extinguisher shall be secured in a mounted bracket, located in the driver’s compartment and readily accessible to the driver and passengers. A pressure gauge shall be mounted on the extinguisher and shall be easily read without moving the extinguisher from its mounted position.

2. The fire extinguisher shall have a rating of 2-A:10-BC, or greater. The operating mechanism shall be secured with a type of seal that will not interfere with the use of the fire extinguisher.

B. First aid kit

1. The bus shall have a removable, moisture-proof and dust-proof first aid kit in an accessible place in the driver's compartment. It shall be mounted and identified as a first aid kit. The location for the first aid kit shall be marked. Contents of the first aid kit shall be in compliance with state standards.
2. Suggested contents include:
  - 2 – 1 inch x 2½ yards of adhesive tape rolls
  - 24 – Sterile gauze pads 3x3 inches
  - 100 – ¾ x 3 inches adhesive bandages
  - 8 – 2 inch bandage compress
  - 10 – 3 inch bandage compress
  - 2 – 2 inch x 6 feet sterile gauze roller bandages
  - 2 – Non-sterile triangular bandages, minimum 39x35x54 inches with 2 safety pins
  - 3 – Sterile gauze pads 36x36 inches
  - 3 – Sterile eye pads
  - 1 – Rounded-end scissors
  - 1 – Pair medical examination gloves
  - 1 – Mouth-to-mouth airway

C. Body fluid clean-up kit

Each bus shall have a removable and moisture-proof body fluid clean-up kit accessible to the driver. It shall be mounted and identified as a body fluid clean-up kit. Contents of the body fluid clean-up kit shall be in compliance with state standards.

D. Warning devices

Each school bus shall contain at least 3 retroreflective triangle road warning devices that meet the requirements of FMVSS No. 125, *Warning Devices*. They shall be mounted in an accessible place.

- E. Any piece of emergency equipment may be mounted in an enclosed compartment, provided the compartment is labeled in not less than 1 inch letters, identifying each piece of equipment contained therein.

### **FIRE SUPPRESSION SYSTEMS (OPTIONAL)**

Fire suppression system nozzles shall be located in the engine compartment, under the bus, in the electrical panel or under the dash, but they shall not be located in the passenger

compartment. The system must include a lamp or buzzer to alert the driver that the system has been activated.

## FLOORS

- A. The floor in the under-seat area, including tops of wheelhousings, driver's compartment and toeboard, shall be covered with an elastomer floor covering, having a minimum overall thickness of  $\frac{1}{8}$  inch and a calculated burn rate of 0.1 or less, using the test methods, procedures and formulas listed in FMVSS No. 302, *Flammability of Interior Materials*. The driver's area and toeboard area in all Type-A buses may be manufacturer's standard flooring and floor covering.
- B. The floor covering in the aisles shall be ribbed or other raised pattern elastomer and have a calculated burn rate of 0.1 or less using the test methods, procedures and formulas listed in FMVSS No. 302. Minimum overall thickness shall be  $\frac{3}{16}$  inch measured from tops of ribs.
- C. The floor covering must be permanently bonded to the floor and must not crack when subjected to sudden changes in temperature. Bonding or adhesive material shall be waterproof and shall be a type recommended by the manufacturer of floor-covering material. All seams shall be sealed with waterproof sealer.
- D. On Types B, C and D buses, a flush-mounted, screw-down plate that is secured and sealed shall be provided to access the fuel tank sending unit and/or fuel pump. This plate shall not be installed under flooring material.

## HANDRAILS

At least 1 handrail shall be installed. The handrail(s) shall assist passengers during entry or exit, and shall be designed to prevent entanglement, as evidenced by the passing of the NHTSA string and nut test.

## HEATING AND AIR CONDITIONING SYSTEMS

- A. Heating System
  - 1. The heater shall be hot water and/or combustion type.
  - 2. If only one heater is used, it shall be fresh-air or combination fresh-air and re-circulation type.
  - 3. If more than one heater is used, additional heaters may be re-circulating air type.
  - 4. The heating system shall be capable of maintaining bus interior temperatures, as specified in test procedure SAE J2233.
  - 5. Auxiliary fuel-fired heating systems are permitted, provided they comply with the following:



- a. The auxiliary heating system shall utilize the same type fuel as specified for the vehicle engine;
  - b. The heater(s) may be direct, hot air-type or may be connected to the engine coolant system;
  - c. An auxiliary heating system, when connected to the engine coolant system, may be used to preheat the engine coolant or preheat and add supplementary heat to the heating system;
  - d. Auxiliary heating systems must be installed pursuant to the manufacturer's recommendations and shall not direct exhaust in such a manner that will endanger bus passengers;
  - e. All combustion heaters shall be in compliance with current Federal Motor Carrier Safety Regulations;
  - f. The auxiliary heating system shall require low voltage; and
  - g. Auxiliary heating systems shall comply with FMVSS No. 301, *Fuel System Integrity*, and all other applicable FMVSSs, as well as with SAE test procedures.
6. All forced-air heaters installed by body manufacturers shall bear a name plate that indicates the heater rating in accordance with SBMTC-001, *Standard Code for Testing and Rating Automotive Bus Hot Water Heating and Ventilating Equipment*. The plate shall be affixed by the heater manufacturer and shall constitute certification that the heater performance is as shown on the plate.
  7. Heater hoses shall be adequately supported to guard against excessive wear due to vibration. The hoses shall not dangle or rub against the chassis or any sharp edges and shall not interfere with or restrict the operation of any engine function. Heater hoses shall conform to SAE J20c, *Coolant System Hoses*. Heater lines on the interior of the bus shall be shielded to prevent scalding of the driver or passengers.
  8. Each hot water system installed by a body manufacturer shall include one shut-off valve in the pressure line and one shut-off valve in the return line, with both valves at the engine in an accessible location, except that on Types A and B buses the valves may be installed in another accessible location.
  9. Each hot water heating system shall be equipped with a device installed in the hot water pressure line that regulates the water flow to all heaters. The device shall be located for convenient operation by the driver while seated.
  10. Accessible bleeder valves for removing air from the heater shall be installed in an appropriate place in the return lines of body company-installed heater.

11. Access panels shall be provided to make heater motors, cores and fans readily accessible for service. An exterior access panel to the driver's heater may be provided.

B. Air Conditioning (Optional)

The following specifications are applicable to all types of school buses that may be equipped with air conditioning. This section is divided into two parts. Part 1 covers performance specifications and Part 2 covers other requirements applicable to all buses.

1. Performance Specifications

The installed air conditioning system should cool the interior of the bus from 100 degrees to 80 degrees Fahrenheit, measured at three points (minimum) located four feet above the floor on the longitudinal centerline of the bus. The three required points shall be: (1) near the driver's location, (2) at the longitudinal midpoint of the body, and (3) two feet forward of the emergency door or, for Type D rear-engine buses, 2 feet forward of the end of the aisle.

The test conditions under which the above performance must be achieved shall consist of (1) placing the bus in a room (such as a paint booth) where ambient temperature can be maintained at 100 degrees Fahrenheit; (2) heat-soaking the bus at 100 degrees Fahrenheit with windows open for at least one hour; and (3) closing windows, turning on the air conditioner with the engine running at the chassis manufacturer's recommended low idle speed, and cooling the interior of the bus to 80 degrees Fahrenheit, or lower, within 30 minutes while maintaining 100 degrees Fahrenheit outside temperature.

Alternately, and at the user's discretion, this test may be performed under actual summer conditions, which consist of temperatures above 85 degrees Fahrenheit, humidity above 50% with normal sun loading of the bus and the engine running at the engine manufacturer's recommended low idle speed. After a minimum of one hour of heat-soaking, the system shall be turned on and must provide a minimum of a 20 degree temperature drop in the 30 minute time limit.

The manufacturer shall provide facilities for the user or user's representative to confirm that a pilot model of each bus design meets the above performance requirements.

2. Other Requirements

- a. Evaporator cases, lines and ducting (as equipped) shall be designed in such a manner that all condensation is effectively drained to the exterior of the bus below the floor level under all conditions of vehicle movement and without leakage on any interior portion of the bus;

- b. Evaporators and ducting systems shall be designed and installed to be free of projections or sharp edges. Ductwork shall be installed so that exposed edges face the front of the bus and do not present sharp edges;
- c. On school buses equipped with Type-2 seatbelts having anchorages above the windows, the evaporator and ducting (if used) shall be placed at a height sufficient to not obstruct occupant securement anchorages. This clearance shall be provided along the entire length of the passenger area on both sides of the bus interior;
- d. The body may be equipped with insulation, including sidewalls, roof, firewall, rear, inside body bows and plywood or composite floor insulation to reduce thermal transfer;
- e. All glass (windshield, service and emergency doors, side and rear windows) may be equipped with maximum integral tinting allowed by federal, state or ANSI standards for the respective locations, except that windows rear of the driver's compartment, if tinted, shall have approximately 28% light transmission;
- f. Electrical generating capacity shall be provided to accommodate the additional electrical demands imposed by the air conditioning system;
- g. Roofs may be painted white to aid in heat dissipation (See APPENDIX B); and
- h. Air intake for any evaporator assembly(ies), except for front evaporator of Type A-1, shall be equipped with replaceable air filter(s) accessible without disassembly of evaporator case.

## **HINGES**

All exterior metal door hinges shall be designed to allow lubrication to be channeled to the center 75% of each hinge loop without disassembly, unless they are constructed of stainless steel, brass or non-metallic hinge pins or other designs that prevent corrosion.

## **IDENTIFICATION**

- A. The body shall bear the words "SCHOOL BUS" in black letters at least 8 inches high on both front and rear of the body or on signs attached thereto. Lettering shall be placed as high as possible without impairment of its visibility. Letters shall conform to "Series B" of Standard Alphabets for Highway Signs. "SCHOOL BUS" lettering shall have a reflective background, or as an option, may be illuminated by backlighting. MFSABs are exempt from these requirements.
- B. Required lettering and numbering shall include:
  - 1. District, company name or owner of the bus displayed at the beltline.

2. The bus identification number displayed on the sides, on the rear and on the front.
- C. Other lettering, numbering or symbols which may be displayed on the exterior of the bus shall be limited to:
1. Bus identification number, minimum 12 inch high characters, on top of the bus, in addition to required numbering on the sides, rear and front;
  2. The location of the battery(ies) identified by the word “BATTERY” or “BATTERIES” on the battery compartment door in 2 inch lettering;
  3. Symbols or letters not to exceed 64 square inches of total display near the entrance door, displaying information for identification by the students of the bus or route served;
  4. Manufacturer, dealer or school identification or logos;
  5. Symbols identifying the bus as equipped for or transporting students with special needs as noted in SPECIALLY EQUIPPED SCHOOL BUS SPECIFICATIONS;
  6. Lettering on the rear of the bus relating to school bus flashing signal lamps or railroad stop procedures; and
  7. Identification of fuel type in 2 inch lettering adjacent to the fuel filler opening.

### **INSIDE HEIGHT**

Inside body height shall be 72 inches or more, measured metal to metal, at any point on the longitudinal centerline from the front vertical bow to the rear vertical bow. Inside body height of Type A-1 buses shall be 62 inches or more.

### **INSULATION (OPTIONAL)**

- A. If thermal insulation is specified, it shall be fire-resistant, UL approved, with minimum R-value of 5.5. Insulation shall be installed so as to prevent sagging.
- B. If floor insulation is required, it shall be 5-ply softwood plywood, nominal  $\frac{5}{8}$  inch thickness and shall be equal to or exceed properties of the exterior-type, C-D Grade, as specified in the standard issued by U.S. Department of Commerce. When plywood is used, all exposed edges shall be sealed. Type A-1 buses may be equipped with nominal  $\frac{1}{2}$  inch-thick plywood or equivalent material meeting the above requirements. Equivalent material may be used to replace plywood, provided it has equal or greater insulation R-value, sound abatement, deterioration-resistant and moisture-resistant properties.

## INTERIOR

- A. The interior of the bus shall be free of all unnecessary projections, which include luggage racks and attendant handrails, to minimize the potential for injury. This specification requires inner lining on ceilings and walls. If the ceiling is constructed with lap joints, the forward panel shall be lapped by rear panel and exposed edges shall be beaded, hemmed, flanged or otherwise treated to minimize sharp edges. Buses may be equipped with a storage compartment for tools, tire chains and/or tow chains. (See BUS BODY SPECIFICATIONS, Storage Compartment.)
- B. Interior overhead storage compartments may be provided if they meet the following criteria:
  - 1. Head protection requirements of FMVSS No. 222, *School Bus Passenger Seating and Crash Protection*, where applicable;
  - 2. Be completely enclosed and equipped with latching door (both door and latch sufficient to withstand a pushing force of 50 pounds applied at the inside center of the door);
  - 3. Have all corners and edges rounded with a minimum radius of 1 inch or be padded equivalent to door header padding;
  - 4. Be attached to the bus sufficiently to withstand a force equal to 20 times the maximum rated capacity of the compartment; and
  - 5. Have no protrusions greater than ¼ inch.
- C. The driver's area forward of the foremost padded barriers will permit the mounting of required safety equipment and vehicle operation equipment.
- D. Every school bus shall be constructed so that the noise level at the ear of the occupant nearest to the primary vehicle noise source shall not exceed 85 dBA when tested according to the procedure described in APPENDIX B.

## LAMPS AND SIGNALS

- A. Interior lamps which illuminate the aisle and the stepwell shall be provided. The stepwell lamp shall be illuminated by an entrance door-operated switch, to illuminate only when headlamps and clearance lamps are on and the entrance door is open.
- B. Body instrument panel lamps may be controlled by an independent rheostat switch or may be controlled by the rheostat that operates the gauge lighting.
- C. School bus alternately flashing signal lamps shall be provided, as described by law. MFSAB's are exempt from this requirement.
  - 1. The bus shall be equipped with 2 red lamps at the rear of the vehicle and 2 red lamps at the front of the vehicle.

2. In addition to the 4 red lamps described above, 4 amber lamps shall be installed so that 1 amber lamp is located near each red signal lamp, at the same level, but closer to the vertical centerline of the bus. The system of red and amber signal lamps shall be wired so that amber lamps are energized manually. The red lamps are automatically energized and amber lamps are automatically de-energized when stop signal arms are extended or when the bus entrance door is opened. An amber pilot lamp and a red pilot lamp shall be installed adjacent to the driver controls for the flashing signal lamp to indicate to the driver which lamp system is activated.
3. For background color requirements refer to appropriate state specification requirements.
4. Red lamps shall flash at any time the stop signal arm is extended.
5. All flashers for alternately flashing red and amber signal lamps shall be enclosed in the body in a readily accessible location.

D. Turn signal and stop/tail lamps

1. The bus body shall be equipped with amber rear turn signal lamps that are at least 7 inches in diameter or, if a shape other than round, a minimum 38 square inches of illuminated area and shall meet FMVSS No. 108, *Lamps, Reflective Devices, and Associated Equipment*. These signal lamps must be connected to the chassis hazard warning switch to cause simultaneous flashing of turn signal lamps when needed as a vehicular traffic hazard warning. Turn signal lamps are to be placed as wide apart as practical and their horizontal centerline shall be a maximum of 12 inches below the rear window. Type A-1 conversion vehicle lamps must be at least 21 square inches in lens area and must be in the manufacturer's standard color.
2. Buses shall be equipped with amber side-mounted turn signal lamps. The turn signal lamp on the left side shall be mounted rearward of the stop signal arm and the turn signal lamp on the right side shall be mounted rearward of the entrance door.
3. Buses shall be equipped with 4 combination red stop/tail lamps.
  - a. Two combination lamps with a minimum diameter of 7 inches, or if a shape other than round, a minimum 38 square inches of illuminated area shall be mounted on the rear of the bus just inside the turn signal lamps.
  - b. Two combination lamps with a minimum diameter of 4 inches, or if a shape other than round, a minimum of 12 square inches of illuminated area, shall be placed on the rear of the body between the beltline and the floor line. The rear license plate lamp may be combined with 1 lower tail lamp. Stop lamps shall be activated by the service brakes

and shall emit a steady light when illuminated. Type A-1 buses with bodies supplied by chassis manufacturer may be equipped with the manufacturer's standard stop and tail lamps.

- E. On buses equipped with a monitor for the front and rear lamps of the school bus, the monitor shall be mounted in full view of the driver. If the full circuit current passes through the monitor, each circuit shall be protected against any short circuit or intermittent shorts by a fuse circuit breaker, or electronic protection device.
- F. An optional white flashing strobe lamp may be installed on the roof of a school bus, at a location not to exceed  $\frac{1}{3}$  the body length forward from the rear of the roof edge. The lamp shall have a single clear lens emitting light 360 degrees around its vertical axis and it may not extend above the roof more than the maximum legal height. A manual switch and a pilot lamp shall be included to indicate when the lamp is in operation. Optionally, the strobe lamp may be mounted on the roof in the area directly over the restraining barrier on the driver's side; may be wired to activate with the amber alternately flashing signal lamps, continuing through the full loading or unloading cycle; and may be equipped with an override switch to allow activation of the strobe at any time for use in inclement weather.
- G. The bus body shall be equipped with 2 white rear backup lamps that are at least 4 inches in diameter or, if a shape other than round, a minimum of 12 square inches of illuminated area and shall meet FMVSS No. 108. If backup lamps are placed on the same horizontal line as the brake lamps and turn signal lamps, they shall be to the inside.

## **METAL TREATMENT**

- A. All metal except high grade stainless steel or aluminum used in construction of the bus body shall be zinc-coated or aluminum-coated or treated to prevent corrosion. This includes but is not limited to such items as structural members, inside and outside panels, door panels and floor sills. Excluded are such items as door handles, grab handles, interior decorative parts and other interior plated parts.
- B. All metal parts that will be painted, in addition to the above requirements, shall be chemically cleaned, etched, zinc phosphate-coated and zinc chromate or epoxy-primed to improve paint adhesion.
- C. In providing for these requirements, particular attention shall be given to lapped surfaces, welded connections of structural members, cut edges on punched or drilled hole areas in sheet metal, closed or box sections, unvented or undrained areas and surfaces subjected to abrasion during vehicle operation.
- D. As evidence that the above requirements have been met, samples of materials and sections used in the construction of the bus body shall not lose more than 10 percent of material by weight when subjected to a 1,000-hour salt spray test, as provided for in the latest revision of ASTM Standard B-117.

## **MIRRORS**

- A. The interior glass mirror shall be either laminated or tempered and shall have rounded corners and protected edges. Mirrors shall be 6x16 inches minimum for Type A buses and be 6x30 inches minimum for Types C and D buses.
- B. Each school bus shall be equipped with exterior mirrors meeting the requirements of FMVSS No. 111, *Rearview Mirrors*. The right side rear view mirror shall not be obscured by the unwiped portion of the windshield. Mirrors shall be easily adjustable, but shall be rigidly braced, so as to reduce vibration.
- C. Heated external mirrors may be used.
- D. Remote controlled external rear view mirrors may be used.

## **MOUNTING**

- A. The rear body cross member shall be supported by the chassis frame. Except where chassis components interfere, the bus body shall be attached to the chassis frame at each main floor sill in such a manner as to prevent shifting or separation of the body from the chassis under severe operating conditions.
- B. Isolators shall be installed at all contact points between the body and the chassis frame on Types A-2, B, C and D buses, and shall be secured by a positive means to the chassis frame or body to prevent shifting, separation, or displacement of the isolators under severe operating conditions.

## **OVERALL LENGTH**

Overall length of the bus shall not exceed 45 feet, excluding accessories.

## **OVERALL WIDTH**

Overall width of bus shall not exceed 102 inches, excluding accessories.

## **PUBLIC ADDRESS SYSTEM**

- A. Buses may be equipped with an AM/FM/audio and/or public address system having interior and exterior speakers.
- B. No internal speakers, other than the driver's communication systems, may be installed within 4 feet of the driver's seat back in its rearmost upright position.

## **RETROREFLECTIVE MATERIAL**

(See also APPENDICES A and B, Retroreflective Sheeting.)



- A. The front and/or rear bumper may be marked diagonally 45 degrees down toward the centerline of the pavement with  $2\pm\frac{1}{4}$  inch wide strips of non-contrasting retroreflective material.
- B. The rear of the bus body shall be marked with strips of retroreflective NSBY material to outline the perimeter of the back of the bus using material which conforms with the requirements of FMVSS No. 131, *School Bus Pedestrian Safety Devices*, Table 1. The perimeter marking of rear emergency exits per FMVSS No. 217, *Bus Emergency Exits and Window Retention and Release*, and/or the use of retroreflective “SCHOOL BUS” signs partially accomplishes the objective of this requirement. To complete the perimeter marking of the back of the bus, strips of at least  $1\frac{3}{4}$  inch retroreflective NSBY material shall be applied horizontally above the rear windows and above the rear bumper, extending from the rear emergency exit perimeter, marking outward to the left and right rear corners of the bus. Vertical strips shall be applied at the corners connecting these horizontal strips.
- C. “SCHOOL BUS” signs, if not a lighted design, shall be marked with retroreflective NSBY material comprising background for lettering of the front and/or rear “SCHOOL BUS” signs.
- D. Sides of the bus body shall be marked with at least  $1\frac{3}{4}$  inch retroreflective NSBY material, extending the length of the bus body and located (vertically) between the floor line and the beltline.
- E. If used, signs placed on the rear of the bus relating to school bus flashing signal lamps or railroad stop procedures may be retroreflective material, as specified by each state.

## **RUB RAILS**

- A. There shall be 1 rub rail on each side of the bus located at, or no more than 8 inches above, the seat cushion level. They shall extend from the rear side of the entrance door completely around the bus body (except at the emergency door or any maintenance access door) to the point of curvature near the outside cowl on the left side.
- B. There shall be 1 additional rub rail on each side located 10 inches or less above the floor line. The rub rail shall cover the same longitudinal span as the upper rub rail, except at the wheel housing, and it shall extend only to the longitudinal tangent of the right and left rear corners.
- C. Rub rails above the floor line shall be attached at each body post and at all other upright structural members.
- D. Each rub rail shall be 4 inches or more in width in its finished form and shall be constructed of 16-gauge metal or other material of equivalent strength suitable to help protect body side panels from damage. Rub rails shall be constructed in corrugated or ribbed fashion.

- E. Rub rails shall be applied outside the body or outside the body posts. (Pressed-in or snap-on rub rails do not satisfy this requirement.) For Type A-1 vehicles using the body provided by the chassis manufacturer or for Types A-2, B, C and D buses containing the rear luggage or the rear engine compartment, rub rails need not extend around the rear corners.
- F. The bottom edge of the body side skirts shall be stiffened by application of a rub rail, or the edge may be stiffened by providing a flange or other stiffeners.

## SEATS AND RESTRAINING BARRIERS

- A. Passenger Seating
  - 1. School bus design capacities shall be in accordance with 49 CFR, Part 571.3, *Definitions*, and FMVSS No. 222, *School Bus Passenger Seating and Crash Protection*.
  - 2. All seats shall have a minimum cushion depth of 15 inches, a seat back height of 24 inches above the seating reference point, and must comply with all other requirements of FMVSS No. 222. In addition to the fastener that forms the pivot for each seat retaining clip, a secondary fastener may be used in each clip to prevent the clip from rotating and releasing the seat cushion unintentionally.
  - 3. All restraining barriers and passenger seats shall be constructed with materials that enable them to meet the criteria of the *School Bus Seat Upholstery Fire Block Test*.
  - 4. Each seat leg shall be secured to the floor by a minimum of 2 bolts, washers and nuts. Flange-head nuts may be used in lieu of nuts and washers, or seats may be track-mounted in conformance with FMVSS No. 222. If track seating is installed, the manufacturer shall supply minimum and maximum seat spacing dimensions (applicable to the bus) which comply with FMVSS No. 222. This information shall be on a label permanently affixed to the bus.
  - 5. All seat frames attached to the seat rail shall be fastened with 2 or more bolts, washers and nuts, or with flange-head nuts.
  - 6. All school buses (including Type A) shall be equipped with restraining barriers which conform to FMVSS No. 222.
  - 7. A flip-up seat may be installed at any side emergency door. If provided, the flip-up seat shall conform to FMVSS No. 222 and aisle clearance requirements of FMVSS No. 217, *Bus Emergency Exits and Window Retention and Release*. The flip-up seat shall be free of sharp projections on the underside of the seat bottom. The underside of the flip-up seat bottoms shall be padded or contoured to reduce the possibility of clothing being snagged. Flip-up seats shall be constructed to prevent passenger limbs from becoming entrapped between the seat back and the seat cushion when the seat

is in the upright position. The seat cushion shall be designed to rise to a vertical position automatically when it is not occupied.

8. Lap belts shall not be installed on passenger seats in large school buses (over 10,000 pounds GVWR) except in conjunction with child safety restraint systems that comply with the requirements of FMVSS No. 213, *Child Restraint Systems*.

B. Pre-School Age Seating

Passenger seats designed to accommodate a child or infant carrier seat shall comply with FMVSS No. 225, *Child Restraint Anchorage Systems*. These seats shall be in compliance with NHTSA's "Guideline for the Safe Transportation of Pre-school Age Children in School Buses." (**Note:** See A.8, above.)

C. Driver Seat

1. The driver's seat supplied by the body manufacturer shall be a high back seat. The seat back shall be adjustable to 15 degrees minimum, without requiring the use of tools. The seat shall be equipped with a head restraint to accommodate a 5<sup>th</sup> percentile female to a 95<sup>th</sup> percentile adult male, as defined in FMVSS No. 208, *Occupant Crash Protection*.
2. Type A buses may utilize the standard driver's seat provided by the chassis manufacturer.

D. Driver Restraint System

A Type 2 lap/shoulder belt shall be provided for the driver. On buses where the driver's seat and upper anchorage for the shoulder belt are both attached to the body structure, a driver's seat with an integrated Type 2 lap/shoulder belt may be substituted. On buses where the driver's seat and upper anchorage for the shoulder belt are separately attached to both body and chassis structures (i.e., one attached to the chassis and the other attached to the body), a driver's seat with an integrated Type 2 lap/shoulder belt should be used.

The assembly shall be equipped with an emergency locking retractor for the continuous belt system. On all buses except Type A that are equipped with a standard chassis manufacturer's driver's seat, the lap portion of the belt system shall be guided or anchored to prevent the driver from sliding sideways under the belt system. The lap/shoulder belt shall be designed to allow for easy adjustment in order to fit properly and to effectively protect drivers varying in size from 5<sup>th</sup> percentile adult female to 95<sup>th</sup> percentile adult male.

- E. Each bus shall be equipped with a durable webbing cutter having a full width handgrip and a protected, replaceable or non-corrodible blade. The required belt cutter shall be mounted in a location accessible to the seated driver in an easily detachable manner.

## SIDE SKIRTS

School bus body side skirts between the front and rear axles shall extend down to within 2 inches plus or minus, of the horizontal line from the center of the front spindle to the center of the rear axle. The manufacturer may offer optional side skirt lengths that extend lower than this requirement. This measurement shall apply to a new unloaded school bus located on a flat level surface.

## STEERING WHEEL

(See BUS CHASSIS SPECIFICATIONS, Steering Gear.)

## STEPS

- A. The first step at the entrance door shall be not less than 10 inches and not more than 14 inches from the ground when measured from the top surface of the step to the ground, based on standard chassis specifications, except that on Type D vehicles, the first step at the entrance door shall be 12 inches to 16 inches from the ground. An auxiliary step may be provided to compensate for the increase in ground-to-first-step clearance. The auxiliary step is not required to be enclosed.
- B. Step risers shall not exceed a height of 10 inches. **Exception:** When plywood is used on a steel floor or step, the riser height may be increased by the thickness of the plywood.
- C. Steps shall be enclosed to prevent accumulation of ice and snow.
- D. Steps shall not protrude beyond the side body line.

## STEP TREADS

- A. All steps, including the floor line platform area, shall be covered with an elastomer floor covering having a minimum overall thickness of 0.187 inch.
- B. The step covering shall be permanently bonded to a durable backing material that is resistant to corrosion.
- C. Steps, including the floor line platform area, shall have a 1½ inch nosing that contrasts in color by at least 70% measured in accordance with the contrasting color specification in 36 CFR, Part 1192, ADA, *Accessibility Guidelines for Transportation Vehicles*.
- D. Step treads shall have the following characteristics:
  - 1. Abrasion resistance: Step tread material weight loss shall not exceed 0.40 percent, as tested under ASTM D-4060, *Standard Test Method for Abrasion Resistance of Organic Coatings by the Taber Abraser*, (CS-17 Wheel, 1000 gram, 1000 cycle);
  - 2. Weathering resistance: Step treads shall not break, crack, or check after ozone exposure (7 days at 50 phm at 40 degrees C) and Weatherometer

exposure (ASTM D-750, *Standard Test Method for Rubber Deterioration in Carbon-Arc Weathering Apparatus*, 7 days); and

3. Flame resistance: Step treads shall have a calculated burn rate of .01 or less using the test methods, procedures and formulas listed in FMVSS No. 302, *Flammability of Interior Materials*.

## **STIRRUP STEPS**

If the windshield and lamps are not easily accessible from the ground, there may be at least 1 folding stirrup step or recessed foothold installed on each side of the front of the body for easy accessibility for cleaning. There also may be a grab handle installed in conjunction with the step. Steps are permitted in or on the front bumper in lieu of the stirrup steps if the windshield and lamps are easily accessible for cleaning from that position.

## **STOP SIGNAL ARM**

The stop signal arm(s) shall comply with the requirements of FMVSS No. 131, *School Bus Pedestrian Safety Devices*. MFSABs are exempt from these requirements.

## **STORAGE COMPARTMENT (OPTIONAL)**

A storage container for tools, tire chains and/or other equipment may be located either inside or outside the passenger compartment. If inside, it shall be fastened to the floor and have a cover with a positive fastening device.

## **SUN SHIELD**

- A. For Types B, C and D vehicles, an interior adjustable transparent sun shield, with a finished edge and dimensions not less than 6x30 inches, shall be installed in a position convenient for use by the driver.
- B. On Type A buses, the sun shield (visor) shall be installed by the chassis manufacturer.

## **TAILPIPE**

- A. The tailpipe may be flush with, or shall not extend more than 2 inches beyond, the perimeter of the body for side-exit pipe or the bumper for rear-exit pipe.
- B. The tailpipe shall exit to the left of the emergency exit door in the rear of the vehicle or to the left side of the bus in front of or behind the rear drive axle. The tailpipe exit location on all Types A-1 or B-1 buses may be in accordance to the manufacturer's standards. The tailpipe shall not exit beneath any fuel filler location or beneath any emergency door.

## **TOWING ATTACHMENT POINTS**

Rear towing devices (i.e. tow hooks, tow eyes, or other designated towing attachment points) shall be furnished to assist in the retrieval of buses that are stuck and/or for towing buses when a wrecker with a “wheel lift” or an “axle lift” is not available or cannot be applied to the towed vehicle.

- A. Towing devices shall be attached to the chassis frame either by the chassis manufacturer or in accordance with the chassis manufacturer’s specifications.
- B. Each rear towing device shall have a strength rating of 13,500 pounds with the force applied in the rearward direction, parallel to the ground, and parallel to the longitudinal axis of the chassis frame rail.
- C. The towing devices shall be mounted such that they do not project rearward of the rear bumper.

## **TRACTION ASSISTING DEVICES (OPTIONAL)**

- A. Where required or used, sanders shall:
  - 1. Be hopper cartridge-valve type;
  - 2. Have a metal hopper with all interior surfaces treated to prevent condensation of moisture;
  - 3. Have at least 100 pounds (grit) capacity;
  - 4. Have a cover that screws in place on the filler opening of the hopper, thereby sealing the unit airtight;
  - 5. Have discharge tubes extending under the fender wheelhousing to the front of each rear wheel;
  - 6. Have non-clogging discharge tubes with slush-proof, non-freezing rubber nozzles;
  - 7. Be operated by an electric switch with a pilot lamp mounted on the instrument panel located so as to be exclusively controlled by the driver;
  - 8. Be equipped with a gauge to indicate that the hopper has reached the one-quarter level (and needs to be refilled); and
  - 9. Be designed to prevent freezing of all activation components and moving parts.
- B. Automatic traction chains may be installed.

## TRASH CONTAINER AND HOLDING DEVICE (OPTIONAL)

When requested or used, the trash container shall be secured by a holding device that is designed to prevent movement and to allow easy removal and replacement. It shall be installed in an accessible location in the driver's compartment, not obstructing passenger access to the entrance door.

## UNDERCOATING

A. The entire underside of the bus body, including floor sections, cross member and below-floor-line side panels, shall be coated with rust-proofing material for which the material manufacturer has issued to the bus body manufacturer a notarized certification to the bus body manufacturer that materials meet or exceed all performance and qualitative requirements of paragraph 3.4 of Federal Specification TT-C-520b, *Coating Compound, Bituminous, Solvent Type, Underbody (For Motor Vehicles)*, using modified test procedures\* for the following requirements:

1. Salt spray resistance—test modified to 5% salt and 1000 hours;
2. Abrasion resistance; and
3. Fire resistance.

\* (Test panels are to be prepared in accordance with paragraph 4.6.12 of TT-C-520b with modified procedure requiring that the test be made on a 48-hour air-cured film at a thickness recommended by the material manufacturer.)

B. The undercoating material shall be applied with suitable airless or conventional spray equipment to the recommended film thickness and shall show no evidence of voids in the cured film.

## VENTILATION

A. Auxiliary fans shall meet the following requirements:

1. Fans for left and right sides of the windshield shall be placed in a location where they can be adjusted for maximum effectiveness and where they do not obstruct vision to any mirror. **Note:** Type A buses may be equipped with one fan;
2. Fans shall have 6-inch (nominal) diameter; and
3. Fan blades shall be enclosed in a protective cage. Each fan shall be controlled by a separate switch.

B. The bus body shall be equipped with a suitably controlled ventilating system with capacity sufficient to maintain the proper quantity of air flow under operating conditions without having to open a window except in extremely warm weather.

- C. Static-type, non-closeable exhaust ventilation shall be installed in a low-pressure area of the roof.
- D. Roof hatches designed to provide ventilation in all types of exterior weather conditions may be provided.

## **WHEELHOUSING**

- A. The wheelhousing opening shall allow for easy tire removal and service.
- B. Wheel housings shall be attached to the floor panels in a manner to prevent any dust, water or fumes from entering the body. Wheel housings shall be constructed of 16-gauge (or thicker) steel.
- C. The inside height of the wheel housings above the floor line shall not exceed 12 inches.
- D. The wheel housings shall provide clearance for installation and use of tire chains on single or dual (if so equipped) power-driving wheels.
- E. No part of a raised wheelhousing shall extend into the emergency door opening.

## **WINDOWS**

- A. Other than emergency exits designated to comply with FMVSS No. 217, *Bus Emergency Exits and Window Retention and Release*, each side window shall provide an unobstructed opening of at least 9 inches high (but not more than 13 inches high) and at least 22 inches wide, obtained by lowering the window. One window on each side of the bus may be less than 22 inches wide.
- B. Optional tinted and/or frost-free glazing may be installed in all doors or windows.
- C. Windshields shall comply with federal, state and local regulations.

## **WINDSHIELD WASHERS**

A windshield washer system shall be provided.

## **WINDSHIELD WIPERS**

- A. A two-speed or variable speed windshield wiping system, with an intermittent feature, shall be provided and shall be operated by a single switch.
- B. The wipers shall meet the requirements of FMVSS No. 104, *Windshield Wiping and Washing Systems*.

## **WIRING**

- A. Wiring



1. All wiring shall conform to current SAE standards.
2. All wiring shall have an amperage capacity exceeding the design load by at least 25%. All wiring splices are to be accessible and noted as splices on the wiring diagram.
3. A body wiring diagram, sized to be easily read, shall be furnished with each bus body or affixed to an area convenient to the electrical accessory control panel.
4. The body power wire shall be attached to a special terminal on the chassis.
5. Each wire passing through metal openings shall be protected by a grommet.
6. Wires not enclosed within the body shall be fastened securely at intervals of not more than 18 inches. All joints shall be soldered or joined by equally effective connectors, which shall be water-resistant and corrosion-resistant.

B. Circuits

1. Wiring shall be arranged in circuits, as required, with each circuit protected by a fuse breaker or electronic protection device. A system of color and number-coding shall be used and an appropriate identifying diagram shall be provided to the end user, along with the wiring diagram provided by the chassis manufacturer. The wiring diagrams shall be specific to the bus model supplied and shall include any changes to wiring made by the body manufacturer. Chassis wiring diagrams shall be supplied to the end user. The following body interconnecting circuits shall be color-coded, as noted:

<u>FUNCTION</u>	<u>COLOR</u>
Left Rear Directional Lamp	Yellow
Right Rear Directional Lamp	Dark Green
Stop Lamps	Red
Back-up Lamps	Blue
Tail Lamps	Brown
Ground	White
Ignition Feed, Primary Feed	Black

The color of the cables shall correspond to SAE J1128, *Low-Tension Primary Cable*.

2. Wiring shall be arranged in at least 6 regular circuits, as follows:
  - a. Head, tail, stop (brake) and instrument panel lamps;
  - b. Clearance lamps and stepwell lamps that shall be actuated when the entrance door is open;
  - c. Dome lamps;

- d. Ignition and emergency door signal;
  - e. Turn signal lamps; and
  - f. Alternately flashing signal lamps.
- 3. Any of the above combination circuits may be subdivided into additional independent circuits.
  - 4. Heaters and defrosters shall be wired on an independent circuit.
  - 5. Whenever possible, all other electrical functions (such as sanders and electric-type windshield wipers) shall be provided with independent and properly protected circuits.
  - 6. Each body circuit shall be coded by number or letter on a diagram of circuits and shall be attached to the body in a readily accessible location.
- C. Buses may be equipped with a 12-volt power port in the driver's area.
  - D. There shall be a manual noise suppression switch installed in the control panel. The switch shall be labeled and alternately colored. This switch shall be an on/off type that deactivates body equipment that produces noise, including, at least, the AM/FM radio, heaters, air conditioners, fans and defrosters. This switch shall not deactivate safety systems, such as windshield wipers or lighting systems.
  - E. The entire electrical system of the body shall be designed for the same voltage as the chassis on which the body is mounted.

**SPECIALLY  
EQUIPPED  
SCHOOL BUS  
SPECIFICATIONS**



# SPECIALLY EQUIPPED SCHOOL BUS SPECIFICATIONS

## INTRODUCTION

Equipping buses to accommodate students with disabilities is dependent upon the needs of the passengers. While one bus may be fitted with a lift, another may have belts installed to secure child seats. Buses so equipped are not to be considered a separate class of school bus, but simply a regular school bus that is equipped for special accommodations.

The specifications in this section are intended to supplement specifications in the chassis and body sections. In general, specially equipped buses shall meet all the requirements of the preceding sections, plus those listed in this section. It is recognized that the field of special transportation is characterized by varied needs for individual cases and by rapidly emerging technologies for meeting individual student needs. A flexible, “common sense” approach to the adoption and enforcement of specifications for these vehicles, therefore, is prudent.

As defined by 49 Code of Federal Regulations (CFR) §571.3, “*Bus* means a motor vehicle with motive power, except a trailer, designed for carrying more than ten persons” (eleven or more including the driver). This definition also embraces the more specific category, *school bus*. Vehicles with ten or fewer occupant positions (including the driver) are not classified as buses. For this reason, the federal vehicle classification, *multipurpose passenger vehicle* (49 CFR § 571.3), or MPV, must be used by manufacturers for these vehicles in lieu of the classification *school bus*. The definition of *designated seating position* in 49 CFR § 571.3 states that, in the case of “vehicles sold or introduced into interstate commerce for purposes that include carrying students to and from school or related events” and which are “intended for securement of an occupied wheelchair during vehicle operations,” each wheelchair securement position shall be counted as four designated seating positions when determining the classification (whether *school bus* or *MPV*). This classification system does not preclude state or local agencies or these national specifications from requiring compliance of school bus-type MPVs with the more stringent federal standards for school buses. The following specifications address modifications as they pertain to school buses that, with standard seating arrangements prior to modification, would accommodate eleven or more occupants including the driver. If by addition of a power lift, wheelchair positions or other modifications, the capacity is reduced such that vehicles become MPVs, the intent of these specifications is to require these vehicles to meet the same specifications they would have had to meet prior to such modifications, and such MPVs are included in all references to school buses and requirements for school buses which follow.

## DEFINITION

*A specially equipped school bus* is any school bus that is designed, equipped and/or modified to accommodate students with special transportation needs.

## **GENERAL REQUIREMENTS**

- A. Specially equipped school buses shall comply with the *National School Transportation Specifications & Procedures* and with the Federal Motor Vehicle Safety Standards (FMVSS) applicable to their Gross Vehicle Weight Rating (GVWR) category.
- B. Any school bus to be used for the transportation of children who utilize a wheelchair or other mobile positioning device, or who require life-support equipment that prohibits use of the regular service entrance, shall be equipped with a power lift, unless a ramp is needed for unusual circumstances related to passenger needs.

## **AISLES**

All school buses equipped with a power lift shall provide a minimum 30-inch aisle leading from any wheelchair position to at least one emergency exit door. A wheelchair securement position shall never be located directly in front of (blocking) a power lift door location.

## **GLAZING**

Tinted glazing may be installed in all doors, windows and windshields consistent with federal, state and local regulations.

## **IDENTIFICATION**

Specially equipped school buses shall display the International Symbol of Accessibility below the window line. Such emblems shall be white on blue or black background, shall not exceed 12 inches square in size and shall be of a high-intensity retroreflective material meeting the requirements of Federal Highway Administration (FHWA) FP-85, *Standard Specifications for Construction of Roads and Bridges on Federal Highway Projects*.

## **PASSENGER CAPACITY RATING**

In determining the passenger capacity of a school bus for purposes other than actual passenger load (e.g., vehicle classification or various billing/reimbursement models), any location in a school bus intended for securement of a wheelchair during vehicle operation shall be regarded as four designated seating positions, and each lift area shall count as four designated seating positions.

## POWER LIFTS AND RAMPS

- A. The power lift shall be located on the right side of the bus body. **Exception:** The lift may be located on the left side of the bus if, and only if, the bus is only used to deliver students to the left side of one-way streets.
1. A ramp device may be used in lieu of a mechanical lift if the ramp meets all the requirements of the Americans with Disabilities Act (ADA) as found in 36 CFR §1192.23, *Vehicle ramp*.
  2. A ramp device that does not meet the specifications of ADA, but does meet the specifications of paragraph C of this section, may be installed and used, when, and only when, a power lift system is not adequate to load and unload students having special and unique needs. A readily accessible ramp may be installed for emergency exit use. If stowed in the passenger compartment, the ramp must be properly secured and placed away from general passenger contact. It must not obstruct or restrict any aisle or exit while in its stowed or deployed position.
  3. All specially equipped school buses shall provide a level-change mechanism or boarding device (e.g., lift or ramp), complying with paragraph B or C of this section, with sufficient clearances to permit a wheelchair user to reach a securement location.
- B. Vehicle lift and installation
1. General: Vehicle lifts and installations shall comply with the requirements set forth in FMVSS 403, *Platform Lift Systems for Motor Vehicles*, and FMVSS 404, *Platform Lift Installations in Motor Vehicles*.
  2. Design loads: The design load of the lift shall be at least 800 pounds. Working parts, such as cables, pulleys and shafts, which can be expected to wear, and upon which the lift depends for support of the load, shall have a safety factor of at least six, based on the ultimate strength of the material. Non-working parts, such as platform, frame and attachment hardware that would not be expected to wear, shall have a safety factor of at least three, based on the ultimate strength of the material.
  3. Lift capacity: The lifting mechanism and platform shall be capable of operating effectively with a wheelchair and occupant mass of at least 800 pounds.
  4. Controls: (See 49 CFR 571.403, S6.7, *Control systems*.)
  5. Emergency operations: (See 49 CFR 571.403, S6.9, *Backup operation*.)

6. Power or equipment failures: (See 49 CFR 571.403, S6.2.2, *Maximum platform velocity*.)
7. Platform barriers: (See 49 CFR 571.403, S6.4.7, *Wheelchair retention*.)
8. Platform surface: (See 49 CFR 571.403, S6.4.2, S6.4.3, *Platform requirements*.) (See also “Wheelchair or Mobility Aid Envelope” figure at the end of this subsection.)
9. Platform gaps and entrance ramps: (See 49 CFR 571.403, S6.4.4, *Gaps, transitions and openings*.)
10. Platform deflection: (See 49 CFR 571.403, S6.4.5, *Platform deflection*.)
11. Platform movement: (See 49 CFR 571.403, S6.2.3, *Maximum platform acceleration*.)
12. Boarding direction: The lift shall permit both inboard and outboard facing of wheelchair and mobility aid users.
13. Use by standees: Lifts shall accommodate persons who are using walkers, crutches, canes or braces, or who otherwise have difficulty using steps. The platform may be marked to indicate a preferred standing position. **Note:** This item refers to equipment specifications. (Also see section, TRANSPORTATION FOR STUDENTS WITH DISABILITIES AND SPECIAL HEALTH CARE NEEDS, Subsection D, *Special Equipment Use and Operation*, for applicable operational procedures stating that “During lift operations (including manual) no one shall be allowed to stand on the lift platform.”)
14. Handrails: (See 49 CFR 571.403, S6.4.9, *Handrails*.)
15. Circuit breaker: A resettable circuit breaker shall be installed between the power source and the lift motor if electrical power is used. It shall be located as close to the power source as possible, but not within the passenger/driver compartment.
16. Excessive pressure: (See 49 CFR 571.403, S6.8, *Jacking prevention*.)
17. Documentation: The following information shall be provided with each vehicle equipped with a lift:
  - (1) A phone number where information can be obtained about installation, repair and parts. (Detailed written instructions and a parts list shall be available upon request.)



- (2) Detailed instructions regarding use of the lift shall be readily visible when the lift door is open, including a diagram showing the proper placement and positioning of wheelchair/mobility aids on the lift.
18. Training materials: The lift manufacturer shall make training materials available to ensure the proper use and maintenance of the lift. These may include instructional videos, classroom curriculum, system test results or other related materials.
19. Identification and certification: Each lift shall be permanently and legibly marked or shall incorporate a non-removable label or tag that states it conforms to all applicable requirements of the current National School Transportation Specifications and Procedures. In addition and upon request of the original titled purchaser, the lift manufacturer or an authorized representative shall provide a notarized Certificate of Conformance, either original or photocopied, which states that the lift system meets all the applicable requirements of the current National School Transportation Specifications and Procedures.

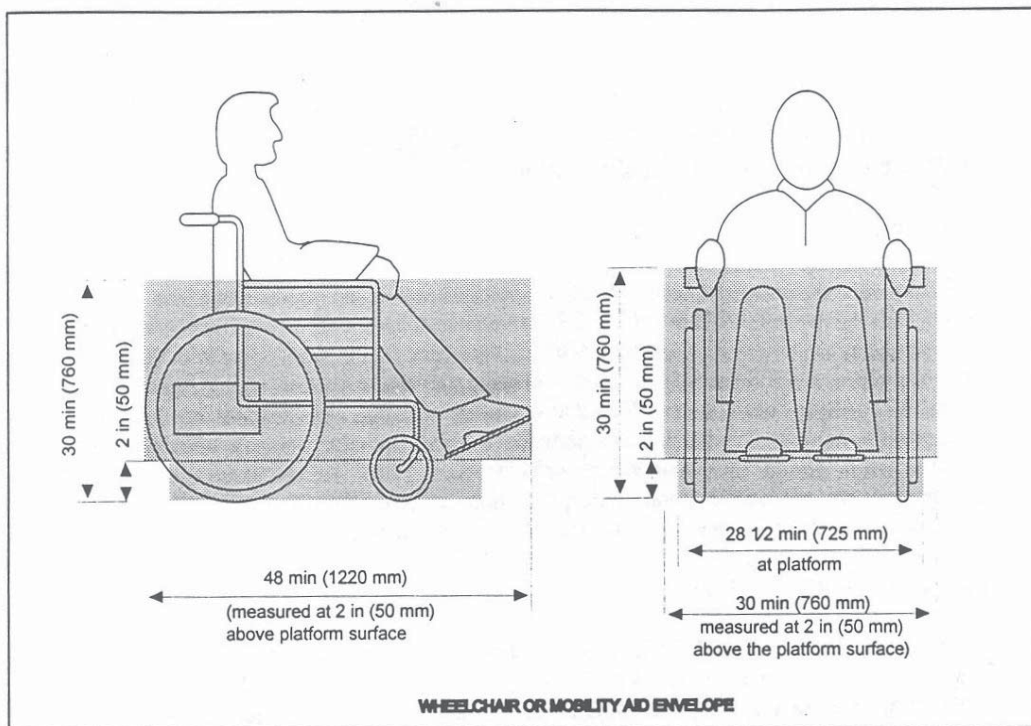

### C. Vehicle ramp

1. If a ramp is used, it shall be of sufficient strength and rigidity to support the special device, occupant and attendant(s). It shall be equipped with a

protective flange on each longitudinal side to keep the special device on the ramp.

2. The surface of the ramp shall be constructed of non-skid material.
3. The ramp shall be equipped with handles and shall be of weight and design to permit one person to put the ramp in place and return it to its storage place.
4. Ramps used for emergency evacuation purposes may be installed in raised floor buses by manufacturers. They shall not be installed as a substitute for a lift when a lift is capable of serving the need.

### **REGULAR SERVICE ENTRANCE**

- A. On power lift-equipped vehicles, steps shall be the full width of the step well, excluding the thickness of the doors in the open position.
- B. A suitable device shall be provided to assist passengers during ingress and egress. This device shall allow for easy grasping or holding and shall have no openings or pinch points that might entangle clothing, accessories or limbs.

### **RESTRAINING DEVICES**

- A. On power lift-equipped school buses with a GVWR of 10,000 pounds or more, seat frames may be equipped with attachment points to which belt assemblies can be attached for use with child safety restraint systems (CSRSs) that comply with FMVSS No. 213, *Child Restraint Systems*. Any belt assembly anchorage shall comply with FMVSS No. 210, *Seat Belt Assembly Anchorages*.
- B. Alternatively, a child restraint anchorage system that complies with FMVSS No. 225, *Child Restraint Anchorage Systems*, may be installed.
- C. Seat belt assemblies, if installed, shall conform to FMVSS No. 209, *Seat Belt Assemblies*.
- D. Child safety restraint systems, which are used to facilitate the transportation of children who in other modes of transportation would be required to use a child, infant or booster seat, shall conform to FMVSS No. 213.

### **SEATING ARRANGEMENTS**

Flexibility in seat spacing to accommodate special devices shall be permitted to meet passenger requirements. All seating shall meet the requirements of FMVSS No. 222, *School Bus Passenger Seating and Crash Protection*.

## SECUREMENT AND RESTRAINT SYSTEM FOR WHEELCHAIRS AND WHEELCHAIR-SEATED OCCUPANTS

For purposes of understanding the various aspects and components of this section, the term *securement and tiedown* and the phrases *securement system or tiedown system* are used exclusively in reference to the devices that anchor the wheelchair to the vehicle. The term *restraint* and the phrase *restraint system* are used exclusively in reference to the equipment that is intended to limit the movement of the wheelchair occupant in a crash or sudden maneuver. The term *wheelchair tiedown and occupant restraint system (WTORS)* is used to refer to the total system that secures the wheelchair and restrains the wheelchair occupant.

### A. WTORS—general requirements:

1. A wheelchair tiedown and occupant restraint system installed in specially equipped school buses shall be designed, installed, and operated for use with forward-facing wheelchair-seated passengers and shall comply with all applicable requirements of FMVSS 222, *School Bus Passenger Seating and Crash Protection*, and SAE J2249, *Wheelchair Tiedown and Occupant Restraint Systems for Use in Motor Vehicles*.<sup>1</sup>
2. The WTORS, including the anchorage track, floor plates, pockets or other anchorages, shall be provided by the same manufacturer or shall be certified to be compatible by manufacturers of all equipment/systems used.
3. Wheelchair securement positions shall be located such that wheelchairs and their occupants do not block access to the lift door.
4. A device for storage of the WTORS shall be provided. When the system is not in use, the storage device shall allow for clean storage of the system, shall keep the system securely contained within the passenger compartment, shall provide reasonable protection from vandalism and shall enable the system to be readily accessed for use.
5. The WTORS, including the storage device, shall meet the flammability standards established in FMVSS No. 302, *Flammability of Interior Materials*.
6. The following information shall be provided with each vehicle equipped with a securement and restraint system:

---

<sup>1</sup> SAE J2249 is currently being updated and moved to Section 18 of ANSI/RESNA Wheelchair Standards, Volume 4, Wheelchairs and Transportation. The new version is expected to be available by December 2006.

- a. A phone number where information can be obtained about installation, repair and parts. (Detailed written instructions and a parts list shall be available upon request.)
  - b. Detailed instructions regarding use, including a diagram showing the proper placement of the wheelchair/mobility aids and positioning of securement devices and occupant restraints, including correct belt angles.
7. The WTORS manufacturer shall make training materials available to ensure the proper use and maintenance of the WTORS. These may include instructional videos, classroom curriculum, system test results or other related materials.
- B. Wheelchair Securement/Tiedown: (See 49 CFR 571.222, S5.4.1, S5.4.2.)
- Each wheelchair position in a specially equipped school bus shall have a minimum clear floor area of 30 inches laterally by 48 inches longitudinally. Additional floor area may be required for some wheelchairs. Consultation between the user and the manufacturer is recommended to ensure that adequate area is provided.
- C. Occupant restraint system: (See 49 CFR 571.222, S5.4.3, S5.4.4.)

### **SPECIAL LIGHT**

Doorways in which lifts are installed shall be equipped with a special light that provides a minimum of two foot-candles of illumination measured on the floor of the bus immediately adjacent to the lift during lift operation.

### **SPECIAL SERVICE ENTRANCE**

- A. Power lift-equipped bodies shall have a special service entrance to accommodate the power lift. **Exception:** A special service entrance shall not be required if the lift is designed to operate within the regular service entrance, is capable of stowing such that the regular service entrance is not blocked in any way and a person entering or exiting the bus is not impeded in any way.
- B. The special service entrance and door shall be located on the right side of the bus and shall be designed so as not to obstruct the regular service entrance. **Exception:** A special service entrance and door may be located on the left side of the bus only if the bus is used only to deliver students to the left side of one-way streets and its use is limited to that function.
- C. The opening may extend below the floor through the bottom of the body skirt. If such an opening is used, reinforcements shall be installed at the front and rear of

the floor opening to support the floor and give the same strength as other floor openings.

- D. A drip molding shall be installed above the special service entrance to effectively divert water from the entrance.
- E. Door posts and headers at the special service entrance shall be reinforced sufficiently to provide support and strength equivalent to the areas of the side of the bus not used for the special service entrance.

### **SPECIAL SERVICE ENTRANCE DOORS**

- A. A single door or double doors may be used for the special service entrance.
- B. A single door shall be hinged to the forward side of the entrance unless this would obstruct the regular service entrance. If the door is hinged to the rearward side of the doorway, the door shall utilize a safety mechanism that will prevent the door from swinging open should the primary door latch fail. If double doors are used, the system shall be designed to prevent the door(s) from being blown open by the aerodynamic forces created by the forward motion of the bus, and/or shall incorporate a safety mechanism to provide secondary protection should the primary latching mechanism(s) fail.
- C. All doors shall have positive fastening devices to hold doors in the “open” position when the special service entrance is in use.
- D. All doors shall be weather sealed.
- E. When manually operated dual doors are provided, the rear door shall have at least a one-point fastening device to the header or floor line of the body. The forward-mounted door shall have at least three one-point fastening devices. One shall be to the header, one to the floor line of the body, and the other shall be into the rear door. The door and hinge mechanism shall have strength that is greater than, or equivalent to, the strength of the emergency exit door.
- F. Door materials, panels and structural components shall have strength equivalent to the conventional service and emergency doors. Color, rub rail extensions, lettering and other exterior features shall match adjacent sections of the body.
- G. Each door shall have windows set in a waterproof manner that are visually similar in size and location to adjacent non-door windows. Glazing shall be of the same type and tinting (if applicable) as standard fixed glass in other body locations.

- H. Door(s) shall be equipped with a device that will actuate an audible or flashing signal located in the driver's compartment when the door(s) is not securely closed and the ignition is in the "on" position.
- I. A switch shall be installed so that the lift mechanism will not operate when the lift platform door(s) is closed.
- J. Special service entrance doors shall be equipped with padding at the top edge of the door opening. The padding shall be at least three inches wide and one inch thick and shall extend the full width of the door opening.

## **SUPPORT EQUIPMENT AND ACCESSORIES**

- A. Each specially equipped school bus that is set up to accommodate wheelchairs or other assistive or restraint devices with belts attached shall contain at least one webbing cutter properly secured in a location within reach of the driver while belted into his/her driver's seat. The belt cutter shall be durable and designed to prevent the operator or others from being cut during use.
- B. Special equipment or supplies that are used in the bus for mobility assistance, health support or safety purposes shall meet local, federal and engineering standards that may apply, including requirements for proper identification.

Equipment that may be used for these purposes includes, but is not limited to:

- 1. Wheelchairs and other mobile seating devices. (See subsection on Securement and Restraint System for Wheelchairs and Wheelchair-seated Occupants.)
  - 2. Crutches, walkers, canes and other ambulating devices to assist ambulation.
  - 3. Medical support equipment. This may include respiratory devices, such as oxygen bottles (which should be no larger than 22 cubic feet for liquid oxygen and 38 cubic feet for compressed gas) or ventilators. Tanks and valves should be located and positioned to protect them from direct sunlight, bus heater vents or other heat sources. Other equipment may include intravenous and fluid drainage apparatus.
- C. All portable equipment and special accessory items, including the equipment listed above, shall be secured at the mounting location to withstand a pulling force of five times the weight of the item or shall be retained in an enclosed, latched compartment. The compartment shall be capable of withstanding forces applied to its interior equal to five times the weight of its contents without failure of the box's integrity and securement to the bus. **Exception:** If these specifications

provide specific requirements for securement of a particular type of equipment (e.g., wheelchairs), the specific specification shall prevail.

## **TECHNOLOGY AND EQUIPMENT, NEW**

It is the intent of these specifications to accommodate new technologies and equipment that will better facilitate the transportation of students with special needs. New technology and equipment is acceptable for use in specially equipped vehicles if:

- A. It does not compromise the effectiveness or integrity of any major safety system. (Examples of safety systems include, but are not limited to, compartmentalization, the eight-lamp warning system, emergency exits and the approved color scheme.)
- B. It does not diminish the safety of the bus interior.
- C. It does not create additional risk to students who are boarding or exiting the bus or are in or near the school bus loading zone.
- D. It does not require undue additional activity and/or responsibility for the driver.
- E. It generally increases efficiency and/or safety of the bus, generally provides for a safer or more pleasant experience for the occupants and pedestrians in the vicinity of the bus and/or generally assists the driver and makes his/her many tasks easier to perform.





# **ALTERNATIVE FUELS**



## ALTERNATIVE FUELS

### INTRODUCTION

This section is designed to be used as an overview of the alternative fuels being utilized for school transportation. It is not designed to replace current applicable federal, state, manufacturing or safety specifications that may exceed requirements within this section. There may be advancements in engineering and improvements in equipment fabrication methods and operating practices that differ from those specifically called for in this section. Such deviations or improvements may provide safety and may meet the intent of, and be compatible with, this section. Entities wishing to purchase alternative-fuel school buses should use this section only as a starting point. More detailed specifications, including specific design and performance criteria and safety specifications, should be researched by prospective purchasers of alternative-fuel school buses.

### GENERAL REQUIREMENTS

Alternative-fuel school buses shall meet the following requirements:

- A. Chassis shall meet all specifications previously mentioned in BUS CHASSIS SPECIFICATIONS.
- B. Chassis shall meet all applicable Federal Motor Vehicle Safety Standards (FMVSSs).
- C. The fuel system integrity shall meet the specified leakage performance standards when impacted by a moving contoured barrier in accordance with test conditions specified in FMVSS No. 301, *Fuel System Integrity*, or FMVSS No. 303, *Fuel System Integrity of Compressed Natural Gas Vehicles*, as applicable.
- D. Original equipment manufacturers (OEMs) and conversion systems using compressed natural gas (CNG) shall comply with National Fire Protection Association (NFPA) Specification 52A, *Compressed Natural Gas Vehicular Fuel Systems*, in effect at the time of installation. Fuel systems using liquefied petroleum gas (LPG) shall comply with NFPA Specification 58A, *Liquefied Petroleum Gases Engine Fuel Systems*, in effect at the time of installation.
- E. All alternative fuel buses shall be capable of traveling not less than 200 miles with a full load, except that those powered solely by electricity shall be capable of traveling not less than 80 miles.
- F. Natural gas-powered buses shall be equipped with an interior/exterior gas detection system. All natural gas-powered buses shall be equipped with an automatic or manual fire detection and suppression system.
- G. All materials and assemblies used to transfer or store alternative fuels shall be installed outside the passenger/driver compartment.

- H. All Types C and D buses using alternative fuels shall meet the same base requirements of BUS CHASSIS SPECIFICATIONS for passenger load.
- I. The total weight shall not exceed the vehicle's GVWR when loaded to rated capacity.
- J. The manufacturer supplying the alternative fuel equipment must provide the owner and operator with adequate training and certification in fueling procedures, scheduled maintenance, troubleshooting and repair of alternative fuel equipment.
- K. All fueling equipment shall be designed specifically for fueling motor vehicles and shall be certified by the manufacturer as meeting all applicable federal, state and industry standards.
- L. All on-board fuel supply containers shall meet all appropriate requirements of the American Society for Mechanical Engineering (ASME) code, DOT regulations or applicable FMVSSs and NFPA standards.
- M. All fuel supply containers shall be securely mounted to withstand a static force of eight times their weight in any direction.
- N. All safety devices that discharge to the atmosphere shall be vented to the outside of the vehicle. The discharge line from the safety relief valve on all school buses shall be located in a manner appropriate to the characteristics of the alternative fuel. Discharge lines shall not pass through the passenger compartment.
- O. A positive, quick-acting (¼ turn) shut-off control valve shall be installed in each gaseous fuel supply line, as close as possible to the fuel supply containers. The valve controls shall be placed in a location easily operable from the exterior of the vehicle. The location of the valve controls shall be clearly marked on the exterior surface of the bus.
- P. An electrical grounding system shall be required for grounding of the fuel system during maintenance-related venting.
- Q. Bio-Diesel must conform to the specifications of ASTM 6751, *Biodiesel Standard*.
- R. High Voltage-Powered Vehicles.

Buses utilizing a high voltage propulsion system (more than 48 nominal volts) shall meet the requirements of FMVSS 305, *Electric Powered Vehicles: Electrolyte Spillage and Electrical Shock Protection*, except for the following:

1. The propulsion power source (batteries, fuel cells, etc.) shall be located outside the passenger compartment.

2. The propulsion power source enclosure shall be constructed to conform to the power source manufacturer's requirements and recommendations.
3. Due to the much larger size and quantities of the propulsion power sources on larger vehicles, buses over 10,000 lbs are permitted to exceed the 5.0 liter spillage constraint of Section S5.1, "Electrolyte damage from propulsion batteries."

## CHARACTERISTICS OF ALTERNATIVE FUELS

For the purpose of this section, alternative fuels refer to the specific fuels listed below. A brief description of each fuel and the advantages and disadvantages of each fuel are shown. (Also see APPENDIX C, Alternative Fuels Comparison Chart.) **Note:** Two other more exotic fuels are being examined: hydrogen and solar power. These two energy sources are in their infancy as alternative fuels for motor vehicles and are not covered within the scope of this section.

### A. Liquid alternative fuels

#### 1. Methanol

Methanol, a liquid at normal ambient temperatures, is colorless and is made primarily from natural gas or coal. Extensive experiments have been conducted with automobile and truck engines powered by methanol. There are a number of urban transit bus fleets currently using methanol. California has experience with methanol as an alternative fuel for school buses through its School Bus Demonstration Project. The findings clearly determined methanol fuel to be costly to operate and unreliable.

##### a. Advantages:

- (1) The principal advantage of methanol is that the emissions produced are quite low in particulates and  $\text{NO}_x$ .
- (2) Methanol mixes with gasoline and can be used as M85 which is 15 percent gasoline and 85 percent methanol with flexible-fuel vehicles running on a blend of the two fuels.
- (3) Methanol has a high octane rating which assists gasoline (spark ignition) engine performance.
- (4) Methanol is biodegradable and readily assimilates with water.
- (5) Methanol burns smokeless.
- (6) Methanol is a domestically produced energy source.

b. Disadvantages:

- (1) Methanol is corrosive, particularly to aluminum. Engines and fuel systems specially designed to handle it use different materials, such as stainless steel.
- (2) Methanol has less than half the power per equivalent gallon (BTU value) as diesel fuel. For an equivalent range, this requires storage tanks twice the size of diesel tanks.
- (3) Methanol is quite toxic. Direct exposure to the human body has the potential of causing blindness and kidney failure. Since it is tasteless and colorless, it cannot easily be detected should it get into a water supply.
- (4) Methanol combustion generates high amounts of formaldehyde, a potential cancer-causing substance. This effect can be offset with exhaust after-treatment, such as the use of special catalytic converters.
- (5) In its pure state, methanol burns with a colorless flame, so a fire is hard to see. It is less volatile than gasoline but has a relatively low flash point of 54 degrees Fahrenheit.
- (6) The distribution system and infrastructure for methanol fueling are considerably less widespread than for gasoline and diesel.
- (7) Methanol has a low cetane rating, which inhibits diesel engine performance. It is not suitable for blending with diesel fuel.
- (8) Methanol has been proven to be unsafe when operating in certain ambient temperature ranges.

2. Ethanol

Ethanol is a distilled agricultural alcohol product that is a liquid and is colorless at normal ambient temperatures. Corn is the current primary grain source. It has many of the same characteristics as methanol. Currently, ethanol is used primarily in a mixture with gasoline, usually no more than 10% ethanol.

a. Advantages:

- (1) Ethanol emissions are quite low in particulates and  $\text{NO}_x$ .

- (2) Like methanol, ethanol readily mixes with gasoline.
- (3) Ethanol is biodegradable and readily assimilates with water.
- (4) Ethanol is less corrosive and less toxic than methanol.
- (5) Ethanol is a domestically produced energy source.

b. Disadvantages:

- (1) The production process is extensive and the steps involved (i.e., planting, fertilizing, harvesting, shipping and processing) consume nearly as much energy as is created by the fuel.
- (2) The energy output of ethanol, though higher than methanol, is still only about half that of diesel fuel; thus, the range of ethanol-powered vehicles is limited for a given fuel storage capacity.
- (3) Ethanol emissions have some visible smoke.
- (4) Ethanol produces formaldehyde; however, this can be offset with an exhaust after-treatment.
- (5) The distribution system and infrastructure for ethanol fueling are considerably less widespread than for gasoline and diesel.

3. Reformulated gasoline

Reformulated gasoline is specially blended fuel with the following properties: a. lower vapor pressure that reduces evaporation during operation and refueling, and b. more efficient combustion through the addition of high-octane oxygenates. Reformulated gasoline aromatic levels have been lowered, which provides less in the way of hydrocarbon tail pipe emissions. Reformulated gasoline (RFG) is required by the EPA in certain metropolitan areas. However, those areas are becoming fewer.

a. Advantages:

- (1) Reformulated gasoline is compatible with all existing gasoline engines.
- (2) The existing fuel-delivery infrastructure is unchanged by this change in fuel properties.

- (3) Reformulated gasoline is a cost-effective alternative in spite of some additional refining costs.

b. Disadvantages:

- (1) Currently there is insufficient oxygenate production and storage (as well as transportation) to provide the oxygenate when and where it is needed.
- (2) Like regular gasoline, reformulated gasoline has a lower caloric (BTU) value than diesel and, thus, provides less engine efficiency than diesel and less range for a given fuel capacity.
- (3) Reformulated gasoline is a fossil fuel and, as such, still leaves the country dependent on foreign sources.
- (4) Reformulated gasoline is not as effective on newer computer-controlled vehicles and is being phased out in some cities.

B. Gaseous alternative fuels

1. Natural gas

Natural gas is primarily methane as it comes from the well, and it burns quite cleanly in its unprocessed state. Natural gas has a higher ignition point (temperature) and a narrower fuel/oxygen mixture combustion range than other fuels. Energy is consumed in processing natural gas to achieve sufficient vehicle storage (i.e., compression or cryogenic processes). (See “Compressed natural gas” and “Liquefied natural gas” sub-sections below.) Natural gas is lighter than air in ambient conditions and does not pool on the ground, a condition that requires buildings used for indoor housing of natural gas vehicles to be adequately ventilated at the ceiling.

2. Compressed natural gas (CNG)

CNG consists primarily of mixtures of hydrocarbon gases and vapors, principally methane (CH<sub>4</sub>) in a gaseous form, which is compressed for use as a vehicular fuel.

a. Advantages:

- (1) Natural gas is readily available as a domestic energy source, is inexpensive and generally produces lower emissions than most other alternative fuels.



- (2) CNG already is in use as a viable alternative for light-duty vehicles. The American Gas Association reports over 700,000 natural gas-powered vehicles in operation in 38 countries. CNG has proven viable for use in school buses.
- (3) CNG burns cleaner and minimizes carbon buildup, thus extending oil change intervals and reducing maintenance.

b. Disadvantages:

- (1) The pressure of CNG requires heavy storage tanks. The tanks are large, even for short-range use. These two factors reduce passenger capacity. Maintaining reasonable passenger capacity restricts tank size and limits range. Lower caloric (BTU) value per equivalent gallon than diesel also limits engine efficiency and vehicle range.
- (2) The high pressure experienced by the CNG fuel storage system requires careful design and location on the vehicle, protection from damage, plus periodic maintenance and upkeep. Periodic tank testing for structural safety is required, and tank replacement during the life cycle of the vehicle may be necessary.
- (3) Refueling time is dependent on the type of fueling system used and can be quite lengthy. There are two methods: (a) “slow-fill,” which takes from five to eight hours and is typically called “overnight” or “time-fill” refueling, and (b) “fast-fill,” which takes about 5 to 10 minutes and requires high-volume compression and special filling apparatus.
- (4) Natural gas compression and refueling equipment is expensive and must be maintained. Fast-fill capability requires an additional “cascade” of high volume storage cylinders, which adds considerable expense to the fueling station.
- (5) There are composition variations in natural gas and the percentage of methane content varies from one area to another. Additional processing is required to get uniform natural gas available in all areas.
- (6) Natural gas has poor lubricative properties.

- (7) There are few fueling stations around the country that are open to the public. Users of CNG, therefore, usually are restricted to operating their buses within range of their own refueling stations.
- (8) The cost of a CNG bus is 40 percent to 50 percent more than that of a conventionally-fueled bus.
- (9) The compressor for a CNG fueling station, whether time-fill or fast-fill has a short life span of approximately 400 hours between rebuilds.

3. Liquefied natural gas (LNG)

LNG utilizes the same natural gas source (primarily methane) as CNG, but requires cooling the gas to temperatures below -260 degrees Fahrenheit (-163 degrees Celsius) to liquefy the natural gas. Converting natural gas to liquid form allows storage of a much greater amount on the vehicle than can be achieved in the gaseous state. The process of liquefying the natural gas also yields almost pure methane gas with predictable performance characteristics.

a. Advantages:

- (1) LNG has all of the combustion advantages of CNG, is readily available, clean burning and generally produces lower emissions than alternatives other than CNG.
- (2) An engine will operate just as easily on LNG as it does on CNG. Though one is stored by compression and the other by cryogenic liquefaction, when CNG or LNG arrives at the point of combustion in the engine it has been converted to its gaseous natural gas state.
- (3) The range of an LNG vehicle is greater than that of a CNG vehicle due to the greater fuel density.
- (4) The LNG fuel system pressure is less than 100 psig as compared to 3000 psig in a CNG system.
- (5) LNG provides almost pure methane with known performance characteristics.
- (6) LNG is capable of being transported in trucks to outlying filling stations, and vehicles may be refueled from the truck.

b. Disadvantages:

- (1) Maintaining the super-cool temperature requires large, heavy, highly insulated tanks which forces a compromise between vehicle range and cargo carried. A lower caloric (BTU) value per equivalent gallon than diesel also limits engine efficiency and vehicle range.
- (2) Equipment to super-cool and liquefy gas is expensive to purchase, operate, and maintain.
- (3) LNG can be kept in the insulated storage tank for seven to ten days. After that, it must be bled off to maintain the cold temperature required to hold the gas in liquid form.
- (4) The bleeding-off process releases hydrocarbons which, in turn, requires treatment to avoid direct release into the atmosphere.
- (5) Natural gas has poor lubricative properties.
- (6) Skin contact with LNG will cause frost burns.

4. Propane (also known as liquefied petroleum gas or LPG)

Propane, or LPG, is sometimes available directly from wells, but is normally produced as a by-product of the gasoline refining process. It has been used for a number of years in light-duty commercial vehicles in urban areas around the world.

a. Advantages:

- (1) Propane burns relatively cleanly. It emits less NO<sub>x</sub> and contains less particulate matter than diesel, and emits less carbon monoxide with fewer hydrocarbons than gasoline.
- (2) The cleaner burning minimizes carbon buildup in the engine, resulting in less maintenance.
- (3) Propane-powered engines start easier in cold weather than either diesel- or gasoline-powered engines.
- (4) The infrastructure for distribution and storage of propane is relatively widespread.

b. Disadvantages:

- (1) As with CNG, propane requires large and heavy fuel tanks to achieve reasonable driving range, due to reduced engine efficiency per equivalent gallon.
- (2) Propane vapors, like gasoline, are heavier than air and are volatile. These explosive mixtures settle in service pits or other spots; therefore, indoor storage is a safety concern.
- (3) As a by-product, propane is dependent on the gasoline process, which limits supply. Further, it does little toward the reduction of dependency on foreign oil.
- (4) Propane has poor lubricative properties.

5. Electric power

The use of electricity as a power source for school buses is an emerging technology that is under considerable research due to the potential for reduced overall emissions. Research is centering on ways to increase the capacity and reduce the weight of batteries, as well as to improve the motors used to power the vehicles and the associated electronics. Battery-charging technology is also developing rapidly. Most of these efforts have the goals of improving the range and performance of electric vehicles, reducing their cost and addressing operational concerns, such as recharging.

a. Advantages:

- (1) Electric-powered vehicles produce no tail pipe emissions.
- (2) The electricity distribution system is currently available since power lines are already in place.
- (3) Electricity can be, and often is, produced from renewable, domestic energy sources.
- (4) Electric-powered vehicles are extremely quiet, due to the lack of internal combustion engines.
- (5) Electric school buses can be produced as hybrid vehicles, which would have a small internal combustion engine to recharge batteries, or to supply heating systems or various other chassis accessories.

- (6) The cost per mile to operate electric-powered vehicles is low. In other words, power source maintenance is practically nil, compared to internal combustion engines.
- (7) Vehicles powered by electric motors offer high torque at low speeds and good overall performance.
- (8) Most purpose-built electric vehicles utilize regenerative braking, which recharges batteries, improves braking performance and improves the life of brake linings.

b. Disadvantages:

- (1) Electric-powered vehicles have a low range due to battery weight and limited electrical storage capacity of current batteries.
- (2) Electric-powered vehicles may not eliminate overall emissions and/or foreign oil dependency if electricity to charge vehicle batteries is produced from coal or oil.
- (3) Current cost of electric power systems for vehicles, including batteries, is extremely high.
- (4) Battery disposal is an environmental concern.
- (5) Significant weight of current batteries limits passenger-carrying capacity.
- (6) Batteries need to be replaced periodically. In some applications, this expense can be a significant portion of the life-cycle cost of operating electric vehicles.

6. Hybrid Electric and Plug-In Hybrid Electric

While technically not an alternative fuel, hybrid vehicles are treated as such in most federal and state programs due to the novel approach to energy use. Straight hybrid electric vehicles are, by far, the largest and fastest growing sector of alternative-fuel vehicles. Plug-in hybrid electric vehicles take advantage of the straight hybrid system, but also allow the user to pre-charge the battery packs to gain additional range and reduce combustion engine usage.

a. Advantages:

- (1) Hybrid vehicles produce significantly less tail pipe emissions.

- (2) Plug-in hybrid vehicles produce even lower emissions when using power from electricity, even considering the power plant emissions.
- (3) Engine wear on hybrids is reduced significantly by reducing strain on the combustion engine and allowing the combustion engine to operate at more optimal points.
- (4) Brake life and performance are significantly increased, due to the use of regenerative braking by the hybrid system to recharge battery packs.
- (5) Hybrid and plug-in hybrid vehicles reduce or eliminate idling, both improving fuel economy and reducing exposure to local vehicle emissions.
- (6) Hybrid electric vehicles are very quiet at low speeds when the electric motors are driving the vehicle alone.
- (7) The cost per mile to operate hybrid electric and plug-in hybrid electric vehicles is low.
- (8) By using electric motors, both hybrid electric and plug-in hybrid electric vehicles offer very high torque at low speeds, and offer superior overall performance. Electric motor reliability is also very high. These motors are often inherently rated many times the life of the vehicle.
- (9) The range of hybrid electric and plug-in hybrid electric is much greater than that of conventional vehicles due to the increase in fuel economy.

b. Disadvantages:

- (1) The use of hybrid and plug-in hybrid vehicles does not eliminate the use of foreign-based petroleum products, nor does it eliminate the production of local and total emissions.
- (2) Hybrid and plug-in hybrid school buses are currently very expensive and are limited in availability.
- (3) Disposal of batteries is difficult, and possibly an environmental concern depending on the choice of battery type by the manufacturer.

- (4) Batteries will need to be replaced periodically. Depending on the choice of battery chemistry, these replacements may be expensive and/or more frequent.
- (5) The choice of battery will also affect the overall weight of the vehicle possibly limiting passenger carrying capacity.

## 7. Bio-diesel

Bio-diesel is a domestic renewable fuel for diesel engines derived from natural oils like soybean oil or animal fat. Bio-diesel can be used in any concentration with petroleum based diesel fuel in existing diesel engines, with little or no modification. While bio-diesel can be used without blending (designated B100), it is generally blended with petroleum-based diesel fuel at 20 to 50 percent (designated B20 or B50 representing the volume percent of bio-diesel). Bio-diesel reduces exhaust pollutants in hydrocarbons (HC), carbon monoxide (CO) and particulate matter (PM). Depending on the engine and duty cycle, nitrogen oxides (NOx) may increase or decrease.

### a. Advantages:

- (1) Significant reduction in three of the four EPA regulated exhaust gases (HC, CO and PM) over petroleum-based diesel.
- (2) Can be blended with petroleum-based diesel to enhance both fuels characteristics.
- (3) Will operate in current diesel engines with little or no modifications.
- (4) Is a domestically produced, renewable source reducing dependency on foreign oil.
- (5) Is biodegradable, less toxic than table salt and degrades faster than sugar.

### b. Disadvantages:

- (1) Bio-diesel can cause deterioration of some seals and hoses, causing fuel or oil leaks, plugged filters and damaged injection pumps. These affects are minimized when using a blend such as B20.

- (2) Bio-diesel acts as a cleaning agent, breaking loose buildup in tanks, causing filter plugging for initial few weeks of operation.
- (3) Refining costs are substantial; therefore, the cost is passed down to the end user. This can be minimized by blending with diesel. It is not available in all areas.
- (4) Use of bio-diesel may result in an increase in exhaust emissions of NO<sub>x</sub>.
- (5) Engine starting ability will be affected in colder climates. The cloud point and pour point is higher than for petroleum-based diesel. Bio-diesel's cloud point is -3 to 12 degrees F and diesel is -15 to 5 degrees F. Pour point of Bio-diesel is -15 to 10 degrees F and diesel is -35 to -15 degrees F.
- (6) Bio-diesel at concentrations of 100 percent (B100) produces 8 percent less energy than petroleum diesel and about 2 percent less with B20.

8. Clean diesel/Ultra-low sulfur diesel

Clean diesel was one of the alternative fuels approved in the Clean Air Act Amendments of 1990. The first step to be undertaken was further refining to reduce sulfur contents and hence the significant particulate emissions caused by the sulfur. Significant advancement in this process has resulted in the development of ultra-low sulfur content diesel fuel. Refinery techniques can now produce diesel fuel with a sulfur content below 15 parts per million (PPM). The availability of this fuel supports the installation of an advanced exhaust after-treatment device in the form of a continuously regenerating filter, known as a diesel particulate filter. This technology reduces the exhaust particulate content by approximately 90 percent from currently mandated levels (to essentially zero). Further steps are being developed to add cetane boosters, which increase efficient combustion.

a. Advantages:

- (1) The additional processing costs are small, so clean ultra-low sulfur diesels are cost-effective relative to other alternative fuels.
- (2) All existing diesel engines currently in service can use clean, ultra-low sulfur diesel without modification.



- (3) The present systems for distribution of diesel fuel are unchanged and are fully usable with clean diesel
- (4) Clean, ultra-low sulfur diesel retains the low level of diesel fuel volatility. This makes it safer than many other alternatives.
- (5) Clean and ultra-low sulfur diesel has a higher BTU value per gallon or equivalent gallon than any other alternative fuel, and thus provides more engine efficiency, as well as more vehicle range.
- (6) Ultra-low sulfur diesel offers significant reductions in emissions.

b. Disadvantages:

- (1) Clean diesel is still relatively high in particulates and  $\text{NO}_x$ .
- (2) Clean, ultra-low sulfur diesel are fossil fuels and, as such, still leave the country dependent on foreign sources.
- (3) When operating under cold conditions, starting is a problem, as with all diesel fuels.
- (4) Ultra-low sulfur diesel is not readily available in most areas of the country.
- (5) Some additives may cause plugging of the fuel filters if they are not compatible with the additives used by the refiner to add lubricity once the sulfur is reduced.



# **OPERATIONS**



# OPERATIONS

## INTRODUCTION

The success of any school transportation operation depends largely on the performance and degree of dedication displayed by those involved. These recommendations are designed to assist state agencies, school administrators and private operators in understanding their student transportation programs and developing applicable policies, including those for transporting students with special needs.

## SCHOOL TRAVEL CHOICES

Children in the United States travel to and from pre-school, school and related activities by a variety of modes. Administrators, parents and students often choose or encourage the use of modes of travel for reasons other than maximizing safety or minimizing risk (e.g., convenience, flexibility, budget). It is recommended that all school students be transported in a school bus.

Each travel mode has its inherent risks, which vary from community to community, school to school and program to program, and any shifts from one mode to another can have a marked effect on the overall safety of travel for a particular community, school or program. Each state, school district, private school, Head Start agency and any other agencies or organizations transporting school-age children must assess its own situation and circumstances and apply the information presented in “The Relative Risks of School Travel – A National Perspective and Guidance for Local Community Risk Assessment” (published by the Transportation Research Board of the National Academies of Sciences and Engineering), to make sound, informed decisions. The goal is to improve safety for all children traveling to and from pre-school, school and related activities and to provide communities with the information needed to make informed choices that balance their needs and resources.

## SCHOOL BUS USE

On July 6, 1999, the National Transportation Safety Board (NTSB) transmitted a Safety Recommendation letter to the Steering Committee of the 13th National Conference on School Transportation containing the findings and recommendation of the Special Investigation Report “Pupil Transportation in Vehicles Not Meeting Federal School Bus Standards” (NTSB/SIR-99/02). This special investigation report was based on the NTSB’s finding in four accidents involving “nonconforming buses”: that a number of children were ejected and fatally injured in three 15-passenger vans and a 25-passenger specialty bus that “did not and were not required to meet Federal school bus occupant crash protection standards.” Recommendation H-99-25, issued in the letter to the National Conference on School Transportation and a number of other national associations and churches, urged recipients to “...inform their members about the circumstances of the accidents discussed in this special investigation report and urge that they use school buses or buses having equivalent occupant protection to school buses to transport children.”

On January 18, 2001, the *Federal Register* (Vol. 66, No. 12) published 45 CFR 1310, “Head Start Transportation,” which included a requirement that on or before January 18, 2006, except

as otherwise provided in §1310, Head Start and Early Head Start passengers shall be transported to and from their respective programs in school buses or allowable alternate vehicles (AAVs), which are like school buses in all respects except that they do not meet FMVSSs for crash avoidance. (In short, AAVs include all school bus design standards except that they are not painted “school bus” yellow and they are not equipped with stop arm and alternately flashing signal lamps for passenger loading and unloading.) The directive (§1310.12) was based on the documented safety of school buses and the knowledge that alternatives to school buses per se would be required by specific states (thus the allowance for AAVs).

The National Highway Traffic Safety Administration, on July 31, 2003, issued the Final Rule for 49 CFR 571 (*Federal Register* Vol. 68, No. 147) that established a new class of school buses called “multifunction school activity buses” (MFSABs) to fulfill the requirements for AAVs (as required by Early Head Start and Head Start, or for “...enabling schools and other institutions to choose the new buses instead of a 15-passenger van [which] will provide them with a safer transportation alternative” (p. 44892).

Therefore, to assure the highest level of safety for children, consistent with the NTSB’s recommendation and 45 CFR 1310, all students transported to and from public and private pre-school programs and schools and to related activities shall be transported in school buses as defined in Title 49, CFR Part 571 or vehicles having passenger crash protection equivalent to school buses, such as multifunction school activity buses (MFSABs).

## **BUSES OTHER THAN SCHOOL BUSES**

Operational Guidelines for the use of buses other than school buses are outlined in APPENDIX D.

## **STATE ADMINISTRATION**

- A. The state agency(ies) responsible for student transportation should provide the following:
  1. Leadership in the development of a comprehensive student transportation program for state-wide application.
  2. A state director of student transportation with the staff and other resources necessary for optimal job performance.
  3. Clear, concise student transportation policies.
  4. A cost accounting system for all expenditures in the area of student transportation.
  5. A state-wide management information system to accommodate student transportation data (e.g., costs, information gleaned from the uniform school bus crash reporting criteria, manpower availability, etc).

6. Promotion of a student transportation safety program utilizing community and school district resources, school bus contractors, school transportation associations, legislation, media, law enforcement and state agencies concerned with student transportation.
7. A manual or handbook for local student transportation supervisors, school administrators and private contractors containing detailed instructions for implementing the state's student transportation laws, regulations and policies.
8. Manuals or handbooks for each school bus driver and each bus attendant containing the state student transportation regulations and recommended safety practices.
9. A comprehensive series of training programs that cover all aspects of student transportation, including, but not limited to:
  - a. A school bus driver program for both pre-service and in-service instruction, including documentation of successful completion of classroom and behind-the-wheel instruction.
  - b. Workshops, seminars and/or conferences for all student transportation personnel.
  - c. Encouragement for state institutions of higher learning to provide undergraduate and graduate courses acceptable for certification purposes in student transportation, operation and safety.
  - d. Safety and safe travel curricula for student passengers.
10. Manuals or handbooks for school bus maintenance personnel, containing technical issues and administrative issues to include appropriate school bus preventive maintenance procedures and ongoing maintenance programs.
11. Regular visits to local school systems to evaluate transportation systems and provide necessary direction.
12. Bus and equipment standards that ensure safe and efficient student transportation.
13. Coordination with other agencies having responsibility for student transportation services and use of the uniform school bus crash reporting criteria.

14. Adequate funding necessary to comply with mandates adopted and approved by state legislatures and the Federal Government.

B. State Student Transportation Director

1. The State Director of Student Transportation's specific duties may include, but are not limited to:
  - a. Assisting in the implementation, interpretation and understanding of student transportation laws, regulations and policies.
  - b. Managing the state's student transportation program, which includes planning, budgeting and forecasting requirements for the operation.
  - c. Supervising the preparation of manuals, handbooks and information for distribution to local transportation personnel and private operators.
  - d. Providing assistance and direction on request to local school administrators and Early Head Start and Head Start grantees or their transporters.
  - e. Assisting in evaluation of state and local operations, including bus routes, and providing recommendations for policies and procedures.
  - f. Planning, directing and participating in safety education for student transportation personnel.
  - g. Assisting local personnel in planning and conducting student safety education programs.
  - h. Requiring and maintaining appropriate reports and records.
  - i. Assisting/consulting with groups involved in student transportation safety.
  - j. Representing the interests of the student transportation industry.
  - k. Working cooperatively with school transportation associations, school districts, Early Head Start and Head Start grantees or transporters, parents and private contractors to promote school bus safety and efficiency.



- l. Developing and publishing easy-to-understand information on the hazards of using prescription drugs and over-the-counter medications when driving.
  - m. Developing and implementing appropriate curricula for training of transportation supervisors, drivers, technicians, attendants and other staff, parents and students.
  - n. Developing and maintaining state-wide data collection and distribution systems regarding safety incident investigations, best practices, general industry information.
  - o. Developing and maintaining a state-wide process for investigating and reporting safety incidents.
2. The State Director of Student Transportation should be an active member of regional and national organizations and should participate in activities that promote student transportation safety.

## **LOCAL SCHOOL DISTRICT ADMINISTRATION**

### **A. Activities**

The local agency responsible for student transportation should supervise the overall transportation operation within the respective agency. Recommended activities include, but are not limited to the following:

1. Assign adequately trained staff the responsibility for implementing and/or supervising a comprehensive student transportation program.
2. Participate in student transportation operations within its jurisdiction, including training programs for all transportation personnel, review of school bus routes, investigation and reporting of crashes and other transportation problems and evaluation of the student transportation system.
3. Ensure compliance with federal and state student transportation laws, regulations and policies, including drug/alcohol testing programs as required in the Omnibus Transportation Employee Testing Act of 1991, and in compliance with 49 CFR, Parts 40 and 382 and with 45 CFR 1310 and other Head Start regulations, as may be applicable.
4. Ensure that instruction in passenger safety, including student participation in emergency evacuation drills, is an integral part of the school and/or Head Start curriculum. Instruction should comply with state requirements and/or Federal Highway Safety Guideline 17 (in APPENDIX D) and with

45 CFR 1310, as may be applicable. Instruction should include, but not be limited to, the following:

- a. At least once each school semester, provide all students transported to and from schools or Head Start Centers in a school bus or multifunction school activity bus with instruction in the location and operation of all emergency exits. Also, provide supervised emergency exit drills to each student transported to or from schools or Head Start Centers in a school bus or multifunction school activity bus. Provide all students with an age-appropriate safe travel curriculum consistent with the modes of travel available for each age group/grade level.
  - b. Before departure on each activity trip, provide all students transported in a school bus, school-chartered bus or multifunction school activity bus instruction on the location of all emergency exits and demonstrations of their operation. Instruction should include a general review of safe riding practices, rules and procedures.
  - c. Limit the amount of carry-on items, especially large items such as luggage, coolers, sports/band equipment, etc., in school buses, school-chartered buses or multifunction school activity buses. Aisles and emergency exits in school buses, school-chartered buses and multifunction school activity buses must be kept clear at all times. Any item that is brought on board must be safely stowed and secured away from any aisle or emergency exit.
5. Provide supervision of loading and unloading areas at or near the school or Head Start Center and provide ongoing evaluation of route pick-up and drop-off locations for safety.
  6. Provide adequate supervision for students whose bus schedules necessitate their early arrival or late departure from school or Head Start.
  7. Promote public understanding of, and support for, the school transportation program.
  8. Develop and implement local student transportation policies and regulations, including those for students with special needs.
  9. Provide transportation personnel the opportunity for growth in job-related activities.

10. Provide the necessary library of resources to ensure that transportation personnel have the proper tools to operate a safe and efficient program. These resources include, but are not limited to:
  - a. Applicable federal, state and local laws, codes and regulations.
  - b. Applicable manuals and guidelines.
  - c. On-line connectivity for access to all internet and other resources.
  - d. Applicable trade journals and organizations' publications.

B. Staffing

The tasks associated with the successful operation of the local transportation department are many and varied. Depending on the size of the district, many duties may be consolidated in a single position, or each position may have very specific duties. The following duties are classified by the type of position that would have stand-alone responsibility, recognizing that an individual may have the responsibilities of several of the designated positions.

1. Administrative

- a. Director, Manager, Supervisor and/or Private Operator

This position is in charge of daily transportation functions. Duties are to plan, direct, coordinate and oversee all functions pertaining to the operation and maintenance of the district transportation department, including personnel, equipment and facilities. Prime concern is safe, efficient and economical transportation of students between home and school on a regular schedule and other destinations, as required by the students' programs or school activities.

- b. Transportation Specialist

This position is often a combination of several job functions. Duties include dispatching, routing (computer or pin maps) and driver training.

2. Support

- a. Dispatcher

The dispatcher is responsible for scheduling and coordinating the transportation of students to and from school and related school

district-sponsored activities and for covering all bus routes by drivers daily. The dispatcher may also schedule motor pool vehicles for district employees and maintain records.

b. Instructor/Trainer

Duties include conducting training for potential new bus drivers and attendants or monitors, conducting training for veteran bus drivers and attendants or monitors and ensuring that training is completed according to federal, state and district requirements.

c. Routing Specialist

Duties include developing and maintaining safe, efficient and cost-effective bus stops and routes and assigning routes to bus drivers.

d. Secretary

Provides secretarial support to the transportation supervisor. Duties may also include preparing department correspondence, answering phones, fielding questions and complaints, referring calls to appropriate staff, preparing payroll and providing support to the dispatcher, instructor/trainer, routing specialist and to shop personnel.

e. Bookkeeper

Provides accounting support for management and issues invoices for services, extracurricular bus trips and maintenance of other department vehicles. Duties may also include preparing purchase orders, authorizing and/or issuing related payment documents and budget reports and ensuring that all financial transactions are properly recorded, totaled, balanced and reconciled with budgeted amounts.

3. Operations

a. Bus Driver

Operates school buses safely under all types of weather, traffic and road conditions, and transports students and other authorized persons on regular and special program routes to and from school and on field, extracurricular and other special activity trips, as authorized by school district officials.

b. Bus Attendant (Monitor or Aide)

Teams with drivers of students with special needs or children enrolled in Head Start or other special programs to provide passengers with a safe ride to and from school, school activities or Head Start Centers. They specialize in meeting students' needs while en route, thus providing students a safe environment in the bus and allowing the driver to focus on operating the bus. Attendants complete specialized training in duties and responsibilities of the position.

4. Vehicle Maintenance

a. Vehicle Maintenance Supervisor, Foreman or Manager

Duties include oversight of preventive maintenance, service and repair of school buses and other district vehicles and equipment, as may be assigned.

b. Journey Technician

Under the direction of the vehicle maintenance supervisor, the journey technician has primary responsibility for maintaining and repairing all school buses and other vehicles, as assigned.

c. Assistant Technician

Under the supervision and direction of the vehicle maintenance supervisor, the assistant technician assists with all mechanical repair and preventive maintenance activities.

(**Note:** Recommended job descriptions for the aforementioned job titles may be found in APPENDIX D.)

## **RESPONSIBILITIES**

### **Driver Responsibilities**

- A. Drivers should be familiar with and abide by all rules, policies and procedures affecting student transportation, including the appropriate use of all equipment and tools in the bus, including electronic communication devices (cellular telephone).
- B. Drivers should recognize the importance of establishing rapport with parents, their supervisors, and school or Center administrators when working to ensure proper student management.

- C. Drivers should establish proper rapport with students.
- D. Drivers should instruct students in appropriate behavior, consequences of improper behavior, general procedures and evacuation drills and safe travel practices. (See APPENDIX D.)
- E. Drivers should maintain order and safety and protect the rights of others in the school bus. They should exercise good judgment and prudence in this pursuit, using appropriate verbal intervention. This includes, but is not limited to, the following:
  - 1. Minimizing interior noise;
  - 2. Requiring an orderly entrance and exit;
  - 3. Eliminating movement or potential movement of objects;
  - 4. Requiring silence at railroad crossings; and
  - 5. Prohibiting transportation of unauthorized materials.
- F. Drivers should handle minor infractions with on-board consequences and discussions approved by the school district or Head Start agency.
- G. Drivers, in instances of serious or recurring misconduct, should follow school district policy pertaining to the misconduct and should submit written reports on appropriate forms to administrators or other persons designated to deal with discipline problems. (See APPENDIX D.)
- H. Drivers should be aware that they represent the school system, Head Start agency and/or the bus company and should present a positive image in dress, language and manner while on duty.
- I. Drivers, including substitute or spare bus drivers, should be familiar with and be provided with written route instructions of the assigned route that would include any existing railroad crossings and any fixed route hazard(s).
- J. The school bus driver is the key to an effective daily inspection program. It is the driver's responsibility to make a planned and systematic inspection of the bus before each route and/or trip, or to assure that the inspection has been completed properly in a timely manner. A recommended procedure requires both stationary and operating inspections. The following outline is not suggested as a model for use but rather is included as a guide for transportation personnel to use in developing a systematic inspection procedure.

Although this section identifies most items to be inspected, state commercial driver's licensing (CDL) requirements may include additional items. All items should be inspected in the method prescribed by CDL requirements and any other applicable regulations.

1. Stationary inspection:

- a. Observe the bus for evidence of oil, fuel, coolant, grease or water leaks, vandalism or damage to the vehicle.
- b. Observe areas around the vehicle for hazards detrimental to vehicle movement.
- c. Be familiar with the under-hood inspection and conduct the under-hood inspection if required to do so.

2. Walk-around inspection:

Before starting the inspection, place the transmission in neutral and set the parking brake (or fully depress the clutch pedal in manual transmission-equipped vehicles), start the engine and inspect the bus from top to bottom and end to end. Check:

- a. Tires (under inflated, flat, excessively worn or damaged, valve stems and caps);
- b. Wheels (loose or missing nuts, excessive corrosion, cracks or other damage and any sign of misalignment);
- c. Fluid leaks (evidence of wetness on inner wheels and tires);
- d. Windows (for dirt, stickers or other obstructions to vision and clean, if necessary);
- e. Mirrors (clean, properly aimed and tightly adjusted);
- f. Warning systems (clean, properly working running lamps, back-up lamps, signals and signs, reflectors, turn signals, stop lamps and warning flashers);
- g. Exhaust system (sagging exhaust pipes, short and leaky tailpipes and defective mufflers);
- h. Emergency exit seals (to prevent possible entrance of dangerous carbon monoxide fumes), hinges and warning buzzer; and

- i. Body for sharp edges, missing or damaged panels, loose rub rails and bumper securement.
3. Inside safety check
- a. Passenger compartment, seats, frames, emergency exits and windows must be carefully checked.
  - b. Inspect instruments and controls. With the engine operating, check the following:
    - (1) Vacuum or air pressure gauge or hydraulic indicator lamps, which should indicate adequate capacity to operate brakes. Loss of air or hydraulic pressure or vacuum indicates a braking deficiency that must be corrected immediately. For buses equipped with electric hydraulic brakes, the driver shall depress the brake pedal with the engine off to check the operation of the backup system.
    - (2) The oil pressure gauge, indicating adequate pressure. The engine should be turned off in the event of inadequate pressure and reported immediately.
    - (3) Warning lamps:
      - (a) Prolonged oil pressure warning lamp, display is a signal of oil pressure problems, and the defect should be reported immediately.
      - (b) Service brake warning lamp displayed during brake application indicates that the brake system is not operating properly.
      - (c) Alternator/generator warning lamp displaying a continuous light “on” after the engine is running indicates a malfunction in the charging system.
      - (d) Ammeter and/or voltmeter indicating any continuous discharge should be reported immediately.
      - (e) Water temperature gauge should always indicate “cool” or “warm.” If it indicates “hot,” the engine should be stopped immediately. The same action should be taken if the temperature warning lamp goes on.



- (f) Anti-lock brake system warning lamp being “on” indicates that the brakes are still functional but the anti-lock system is not.

4. Check each of the following for proper operation, adjustments or condition:

- a. Lamps and signals: turn signals, stop lamps, special warning lamps, emergency flashers, clearance (marker) lamps, headlamps, interior lamps and stop arm lamps;
- b. Stop arm control;
- c. Windshield fan, defrosters and heaters;
- d. Horns;
- e. Entrance (service) door and control;
- f. Mirrors: rear view, side view, convex and elliptical;
- g. Three emergency triangles;
- h. Driver’s seat and restraint system;
- i. Fire extinguisher\*;
- j. First aid kit\*;
- k. Body fluid cleanup kit;
- l. Seat belt cutter\*;
- m. Wipers/washers;
- n. Sanders, when equipped;
- o. Power lift, when equipped;
- p. Spare electrical fuses;
- q. Adaptive equipment devices; and
- r. Crossing control arm, if equipped.

\*(with required signage for Head Start vehicles)

## **Parent/Guardian Responsibilities**

Parents, guardians and persons acting in loco parentis should:

- A. Understand and support district or Head Start Center rules and policies, regulations and principles of school bus safety;
- B. Assist children in understanding safety rules and encourage them to abide by them;
- C. Recognize their own responsibilities for the actions of their children. Understanding this, parents or guardians shall be responsible and accountable for the conduct and safety of their children at all times prior to the arrival and after the departure of the school bus at the assigned school bus stop;
- D. Support safe riding practices and reasonable discipline efforts;
- E. Teach children proper procedures for safely crossing the roadway before boarding and after leaving the bus, as described in APPENDIX D;
- F. Support procedures for emergency evacuation as prescribed by states and school districts and Head Start Centers;
- G. Respect the rights and privileges of others;
- H. Communicate safety concerns to school administrators;
- I. Monitor bus stops, if possible;
- J. Support all efforts to improve school bus safety; and
- K. Be aware of illegal or undesirable activities and other dangers involved in and around the loading and unloading zone, including the dangers of loose clothing, drawstrings, clothing accessories, back-packs and other loose personal items.

## **Student Responsibilities**

Proper student behavior is important because the distraction of the driver can contribute to crashes. Students and parents should be made aware of, and should abide by, reasonable regulations to enhance safety. The consequences of unacceptable behavior should be clearly understood. The following actions will help to protect the student's rights and to maintain order in the bus:

- A. Students should be aware that they are responsible for their actions and behavior.
- B. Students should receive a copy of the rules and procedures and should be required to abide by them.

- C. Students should display respect for the rights and comfort of others.
- D. Students should be taught to realize that school bus transportation can be denied if they do not conduct themselves properly.
- E. Students should be made aware that any driver distraction is potentially hazardous to their safety.
- F. Students should be made aware of the dangers involved in and around the loading and unloading zone, including the dangers of loose clothing, drawstrings, clothing accessories, back-packs and other loose personal items. Students should be trained to cross the road safely at the bus stop. (Refer to APPENDIX D, “Here’s How to Cross the Road SAFELY.” These safety training diagrams show a 12-foot minimum walk distance in front of the bus.) To train students to understand, remember and practice the 12-foot minimum walk distance, one or more of the following instructional methods should be used:
  - 1. Mark the 12-foot walk distance on the ground and have the student, in normal or giant steps, walk off the distance and count the steps. The student’s total steps shall be recorded and the student informed and repeatedly reminded of this total number of steps required for the walk distance.
  - 2. Have the student practice walking ahead of the bus on the right shoulder of the road until the student can clearly see the bus driver’s eyes. (Refer to APPENDIX D, “Crossing the Road Safely.”)
- G. Students should be taught to avoid retrieving articles dropped during loading and unloading, or around the bus, without explicit directions from the driver. They should also be taught to move away from the bus (out of the danger zones) after unloading.

## **OPERATIONAL PROCEDURES**

- A. Policies and Guidelines:

The responsible state agency and the local school district or Head Start agency should have clear and concise policies and guidelines for the operation of their student transportation programs. These are important for two reasons: (1) they have the effect of law when laws or regulations do not specifically address a situation; (2) they serve as the rule book for use by persons charged with the administration of transportation services within the district or qualified agency.

Once established, these policies and guidelines become the basis for development of operating procedures. This allows decisions about operational details to be made at the administrative level rather than by the school board. These policies

and guidelines should be precise and in writing and should cover the following topics:

1. A statement of philosophy;
2. A definition of the agency's goals and objectives;
3. Procedures for determining eligibility for transportation;
4. A description of all types of transportation provided;
5. The days on which service will be available;
6. School starting and closing times;
7. Administrative responsibilities related to program service;
8. Essential routing constraints, such as walking distances and age/grade of students for whom the appropriate agency will provide transportation;
9. The extent of special transportation service;
10. A compilation of student rules and regulations;
11. Provisions and guidelines for the use of contracted transportation and/or charter buses;
12. Provisions and guidelines for the emergency use of personal vehicles to transport students;
13. Acceptable purchasing procedures;
14. Required minimum limits of insurance coverage;
15. The essentials of a crash prevention program, including the uniform school bus crash reporting criteria;
16. A system to communicate procedures between administrators and parents, and between administrators and the bus company or drivers, including student discipline procedures and compliance;
17. A procedure for providing drivers and bus attendants with essential information about students they transport;
18. Emergency procedures and/or contingency plans to be followed in the event of a crash, unexpected school closing or unforeseen route change;

19. Use of special lighting and signaling equipment, as indicated below:
  - a. If the bus is so equipped, use of alternately flashing amber lamps to warn motorists that the bus is preparing to stop to take on or discharge passengers;
  - b. Use of alternately flashing red lamps to inform motorists that the bus is stopped on the roadway to take on or discharge passengers;
  - c. Operating the stop arm(s) in conjunction with the flashing red signal lamps;
  - d. Use of a white flashing strobe lamp (if equipped) to increase the visibility of the school bus on the roadway during adverse visibility conditions;
  - e. Use of a crossing control arm, when installed, to encourage children to cross properly in front of school buses; and
  - f. Use of an outside public address systems for instructing children in crossing road-ways and for informing them of potentially life-threatening situations.
  
20. Personnel
  - a. An organization chart identifying the flow of responsibility from the board of education or Head Start agency to the employees;
  - b. Job specifications and descriptions (provided at the time of employment); and
  - c. Pre-employment and continued employment requirements and procedures should be identified.
  
21. Harassment
  - a. School districts shall develop written policies and procedures dealing with all forms of harassment in the school bus. (Harassment is the use or tolerance of verbal or physical behavior, which serves to threaten, demean, annoy or torment another person. Harassment includes unwanted activities or comments based on race, religion, gender, sexual preference, personal attributes and other acts, as may be determined in local policy.)

- b. School districts shall develop training programs to assist all employees in recognizing harassment and in identifying appropriate interventions and reporting strategies.
- c. School districts shall develop and implement guidelines for administering appropriate disciplinary actions resulting from acts of harassment.

22. Weapons; and

23. Drugs and Alcohol.

B. Driver's and Attendant's Manual/Handbook

Each employer should provide a manual or handbook to each school bus driver and attendant at the time of employment. This manual should include the following subjects:

- 1. Applicable federal and state transportation laws, regulations and policies.
- 2. Motor vehicle rules and regulations applicable to school bus operation.
- 3. Vehicle operation and maintenance, including pre- and post-trip inspections.
- 4. Pre-trip and post-trip inspection procedures (including equipment required for transporting passengers), securing the vehicle and checking for passengers and property at the end of each run, as well as any state or locally required documentation.

Drivers are responsible for conducting a walk-through inspection of the school bus following drop-offs at each school and after the last delivery on each run segment. Prior to departing the bus for any length of time, a walk-through inspection must be conducted. The purpose of the walk-through inspection is to check on and under the seats for sleeping or hiding students and to identify any items that may have been dropped or left aboard the bus. Warning flag systems and/or electronic means may be used. Written policies and procedures should be in place for post-trip and post-run segment checks.

- 5. Procedures to follow when involved in a crash or safety-related incident, when witnessing a crash and when involved with post-crash reporting.
- 6. Elements of basic first aid procedures with knowledge of universal precautions, plus any local practices and policies that may vary from, but should not conflict with, state requirements.

7. Elements of student management, including techniques for dealing with students with specific disabilities.
8. Local school district and employer policies.

C. Seating

1. School buses provide the safest form of student transportation. An integral part of providing “safe” transportation in a school bus is that the passengers must be properly seated. A person who is either standing or improperly seated in a school bus is not afforded the benefits of the safety protection designed into the vehicle and is in increased jeopardy of injury in the event of a crash or sudden driving maneuver.

Additionally, there must be sufficient space on the school bus seat for each passenger’s body to be completely contained within the seat compartment. In the event of a crash or sudden driving maneuver, students that are not properly seated within the seat compartment may not benefit from the passenger crash protection systems built into the school bus under federal and state regulations.

In practice, school buses transport students of various sizes, typically from pre-schoolers to 12<sup>th</sup> graders. While a 39-inch seat may safely accommodate three pre-schoolers and/or primary school-aged children, it may not safely accommodate the same number of older children. Since the size of growing children varies, the number of students that can safely occupy a school bus seat also changes. Consequently, the “in use” capacity of a school bus varies depending on the size of the students transported. The use of a child safety seat or other child safety restraint for an infant, a toddler, or other pre-kindergarten passenger or the use of special equipment, including mobility devices, needed for a child with disabilities, may further impact the “in-use” capacity of a school bus.

It is important to consider the size of the passengers in each school bus route when determining the “in-use” capacity of a school bus. It is recognized that at certain times (for example at the beginning of a school year), it may not be possible to know exactly how many students will arrive at school bus stops on a route. For that reason, there may be instances where overcrowding exists temporarily on some school buses. In such situations, efforts should be made to provide safe seating to all school bus passengers in a timely and efficient manner, so that during regular operations all passengers are safely seated. (**Note:** specific state laws or local regulations may prohibit overloading a bus, even in temporary situations.)

Highway Safety Program Guideline #17, “Pupil Transportation Safety,” as issued by the National Highway Traffic Safety Administration and printed in APPENDIX D, states:

- a. “Standing while school buses and school-charter buses are in motion should not be permitted. Routing and seating plans should be coordinated so as to eliminate passengers standing when a school bus or school-charter bus is in motion [IV.C.2.e.(1)].”
  - b. “...Due to variations in sizes of children of different ages, states and school districts should exercise judgment in deciding how many students are actually transported in a school bus or school-charter bus [IV.C.2.e.(2)].”
  - c. “There should be no auxiliary seating accommodations, such as temporary or folding jump seats in school buses [IV.C.2.e.(3)].”
2. All children riding in school buses, or other buses used to transport students to and from school, Head Start or related activities shall be properly and safely seated facing forward, unless otherwise required by a child safety restraint system (CSRS). There shall be adequate space on the seat for the child to be seated completely within the seating compartment.

The growing number of pre-school-age children who are transported in school buses has increasingly focused attention on the safety of these passengers. In response to questions and concerns raised by parents and by transporters, the National Highway Traffic Safety Administration (NHTSA) conducted crash tests involving pre-school size dummies on school bus seats.

According to NHTSA, “the test results showed that pre-school age children in school buses are safest when transported in child safety restraint systems (CSRSs) that meets [sic] FMVSS 213, Child Restraint Systems, and are correctly attached to the seats.” This quotation, contained in the “Introduction,” NHTSA’s *Guideline for the Safe Transportation of Pre-School Age Children in School Buses* (February 1999), summarizes the basis for the document’s recommendations, which have drawn industry-wide attention and have initiated intense discussions with respect to practicability. (See entire document in APPENDIX F.)

The publication defines a child safety restraint system (CSRS) as “...any device (except a passenger system lap seat belt or lap/shoulder seat belt), designed for use in a motor vehicle to restrain, seat or position a child who weights less than fifty pounds.” CSRSs include infant seats, convertible seats, forward-facing only seats, booster seats with built-in harness, integrated seats and safety vests.



NHTSA’s “Guideline...” was a primary source for requirements for Head Start transportation services contained in 45 CFR 1310, disseminated in the *Federal Register* on January 18, 2001. §1310 specified, among many other requirements, mandatory use of CSRSs in vehicles that transport children to and from Head Start programs and related activities, and the regulation set deadlines for compliance. [A subsequent □Interim Rule,□ published in the *Federal Register* (Vol. 69, No. 11) on January 16, 2004, extended the deadline for compliance and included provisions for further justified and approved extensions.]

Due to the evolutionary nature of the entire issue of CSRSs—product design and construction, appropriate usage, varied state laws and regulations, applicability (recommendation versus regulation), implementation deadlines, etc.—the OPERATIONS section of the *NCST Specifications and Procedures* does not contain specific details regarding applicability, selection, use, maintenance and replacement of CSRSs. More detailed information may be found elsewhere in this publication: BUS BODY SPECIFICATIONS—Seat and Restraining Barriers; SPECIALLY EQUIPPED SCHOOL BUS SPECIFICATIONS—Restraining Devices; GUIDELINES FOR INFANTS, TODDLERS AND PRE-SCHOOL CHILDREN—Equipment, Child Safety Restraint Systems (CSRS), Bus Seat Designated for a Child Safety Restraint System and Special Considerations; and APPENDIX F.

Additional information and guidance are available in “Proper Use of Child Safety Restraint Systems,” “Choosing the Correct School Bus for Transporting Pre-School Age Children” and other NHTSA publications ([www.nhtsa.dot.gov](http://www.nhtsa.dot.gov)), in “Safe Ride News” ([www.saferidenews.com](http://www.saferidenews.com)), from local NHTSA-trained Child Safety Seat Technicians and from local physical therapists.

Transporters of pre-school age and older children in vehicles that use CSRSs minimally should adhere to the following recommendations:

- a. Establish written policies and procedures for...
  - (1) Procurement, maintenance, cleaning and replacement of CSRSs;
  - (2) Registration and tracking equipment recall notices;
  - (3) Inspection;
  - (4) Installation and usage training;

- (5) Occupancy of non-restrained passengers on seats behind restrained passenger;
  - (6) Locations of restrained passengers with respect to emergency exits;
  - (7) Retrofitting school buses with CSRSs; and
  - (8) Emergency procedures.
- b. Ensure adequate training of personnel in the installation, use, care and upkeep of CSRSs.
  - c. Assure age-, height- and weight-appropriate applications of CSRSs.
  - d. Require periodic passenger evacuation drills.
  - e. Establish records files for all CSRSs, to include a complete history of each restraint device.
  - f. Incorporate CSRS usage and proper seat spacing in school bus specifications.
  - g. Monitor developments and changes at the state and federal levels with respect to CSRSs.

#### D. Student Management

An effective student management program is a collaborative effort involving many groups of people in the school community or Head Start agency. Parents, students, school bus drivers, school or Head Start administrators, contract managers (where contract transportation is provided), law enforcement, and social service agencies must be part of the ongoing process to motivate students to good behavior. It is the responsibility of the school district or Head Start agency to ensure that a comprehensive student management program is developed, so that all persons involved in the process are familiar with their responsibilities.

##### 1. School, School District, Head Start and/or Carrier Responsibilities

No public or private school, school district, county board of education, county superintendent of schools or any officer or employee of the school or board of education or Head Start Center shall be responsible or in any way liable for the conduct or safety of any student of the school or Head Start Center at any time when the student is not on school or Head Start Center property, unless the school, board, Head Start agency or person has

undertaken to provide transportation for the student to and from the school or Head Start premises, has undertaken a school- or Head Start-sponsored activity off the premises of the school or Head Start Center, has otherwise specifically assumed the responsibility or liability or has failed to exercise reasonable care under the circumstances.

In the event of the specific undertaking, the school, school district, board of education, Head Start agency or person shall be liable or responsible for the conduct or safety of any student only while the student is, or should be, under the immediate and direct supervision of an employee of the school, school district, board of education or Head Start agency.

In addition, no entity that provides transportation services for students, pursuant to a contract with a school, school district, city or county board of education, county superintendent of schools or Head Start agency, shall be responsible or in any way liable for the conduct or safety of any student of the public or private school or Head Start agency at any time when the student is not under the immediate and direct supervision of an employee of the entity.

Specific responsibilities include the following:

- a. Establish the policies and procedures by which the program functions. These should include, but not be limited to, the examples in APPENDIX D.
- b. Establish regulations governing the behavior and safety of students at the bus stop and while boarding, riding and disembarking from the school bus. The rules students are expected to follow should be limited in number, should be age-appropriate and should be posted in the bus and/or otherwise made available to all riders. (See APPENDIX D.)
- c. Institute and administer an instructional program that teaches students proper conduct and transportation safety procedures. (See APPENDIX D.)
- d. Conduct a training program for school bus drivers and attendants to ensure that all policies, procedures, regulations and their enforcement are understood.
- e. Ensure that parents receive written copies of the bus rules and regulations. Ensure that parents are informed about their responsibilities for the supervision and safety of students going to and from bus stops and while at the bus stops.

(See APPENDIX D.) Clearly establish parents' roles and obligations with respect to student promptness, attitude and behavior.

- f. Initiate procedures to ensure open lines of communication and cooperation among school and Head Start administrators, bus company officials, state agencies, bus drivers and attendants.
- g. Train drivers and attendants in specific skills that will enable them to maintain order, safety and respect for the rights of others. These skills should include at least the following:
  - (1) Specific verbal intervention techniques used to maintain order and safety; and
  - (2) Communication skills that promote rapport and mutual respect, and that encourage student compliance.
- h. Ensure that administrators support and enforce disciplinary procedures, policies and reasonable actions by the driver.

E. Use of video/audio monitoring systems

School systems should promulgate, communicate and enforce policies and procedures to be followed when using on-board video/audio monitoring systems. The video/audio monitoring in a school bus should be used only as an aid to monitor student and driver behavior. It should not replace the discipline policy, the authority of the driver or the responsibility of the school officials. The basic safe riding rules must prevail, and the consequences of misconduct must be carried out.

- 1. All students and drivers shall be notified that they are subject to being video/audio recorded in the school bus at any time. Notification to parents of all students shall be made by the school district. Prior to actual recording, parents and students shall be advised that student conduct prohibited by state and school district student disciplinary code will result in appropriate consequences, as defined in policy.
- 2. Ongoing notification regarding video/audio recording must occur, addressing the continued need for personal awareness of safety issues. This communication is particularly important to warn against a false sense of security, especially when cameras are moved between buses. Newsletters, student handouts and notices posted in the bus should be considered.

3. If video/audio monitoring systems are to be used for monitoring drivers, the drivers must be notified as to the extent of their use and for what purpose they will be used.
4. When a camera rotational plan is used, cameras should be moved so as not to select only certain buses. However, the transportation supervisor and/or school administrator may decide when video monitoring of a bus route should be done more frequently based on the number of incidents of misconduct or the seriousness of these reports. Such additional monitoring is meant to supplement the written disciplinary reports by the bus driver, not to take the place of reports.
5. The transportation supervisor or designee may periodically review recordings as needed to ensure proper student conduct. If no incidents are reported within a period defined by local policy, the tapes will be recycled or the digital recordings deleted. If incidents are reported, or if incidents are viewed during random selection, the video tapes or digital recordings are to be kept until final resolution and time for any appeals.

Tapes or digital recordings must be dated and have the bus number and driver's name in order to ensure proper identification.

6. When action is taken as a result of information obtained from the videotape or digital recording, the driver, supervisor, school administrator, student, and parents or guardians will be contacted. A meeting of the aforementioned parties may be necessary to achieve a resolution of the problem. The videotape or digital recording may be used as evidence in that meeting if state law and school district policy allows it. All requests for review shall be made in writing.
7. Each district must designate by policy those persons who are allowed to review the tapes or digital recordings.

#### F. Records

1. Crash and safety incident investigation records function as the data base for statistical analysis, which, in turn, provides material for crash prevention programs. In addition to the uniform school bus crash reporting criteria, additional crash safety incident investigation records may include the following information:
  - a. If injuries occurred, a list of all students injured, their home addresses phone numbers and dates of birth, the extent of their injuries and appropriate explanations;

- b. A list of bus occupants and witnesses, including addresses, ages, phone numbers and statements;
  - c. Extent of damage and an estimate of repair costs;
  - d. Post-crash data (i.e., disposition of litigation and/or summonses, driver deposition, net effect of personal injuries, remediation (if any), assigned in-service, etc.);
  - e. A signed statement from the bus driver and bus attendant or monitor (if applicable) concerning the particulars of the crash;
  - f. Complaints, challenges and disposition of hearings, etc.; and
  - g. A clear description of the circumstances around what happened:
    - (1) What, where, when, who, and related roadway, area, weather and hazardous conditions information;
    - (2) Related vehicle operating and mechanical information; and
    - (3) Related procedural and operating information for all vehicles and operators involved.
2. Personnel records should contain the information required and allowed under federal and state laws.
  3. US Department of Justice, Employment Eligibility Verification and I-9 forms should be maintained in a separate file or binder.
  4. Driver qualification records should contain at least the following items:
    - a. An application for employment;
    - b. Confirmed work history;
    - c. Driving records;
    - d. Criminal record;
    - e. Physical examination, as required for the type of license and/or special school bus certificate held;
    - f. Copy of drug and alcohol testing information in compliance with current federal, state and company testing requirements; and
    - g. All other items as required by federal and state laws and rules.

5. Training records should contain, at a minimum, accurate information certifying attendance and satisfactory completion of all state and company required training. Details about each training activity, including date of instruction and instructor signature, should be documented and included. The following is a list of minimum training to be documented:
  - a. Classroom Training
    - (1) Pre-service;
    - (2) In-service; and
    - (3) Post-crash or evaluation.
  - b. Behind-the-Wheel Training
    - (1) Written documentation of each activity;
    - (2) A written assessment tool showing satisfactory completion, with rating;
    - (3) Documentation of the type of equipment used, both vehicle and safety; and
    - (4) A log of the number of hours of instruction and practice driving.
6. Route records should contain:
  - a. Types of routes (urban, suburban, rural);
  - b. Route descriptions, including accurate route maps;
  - c. Route miles;
  - d. Information about the needs of special education students;
  - e. Information pertaining to road conditions and hazards utilizing “Identification and Evaluation of School Bus Route and Hazard Marking Systems” developed by NASDPTS (as presented in APPENDIX D); and
  - f. Scheduled pick-up and drop-off times at each bus stop.

7. Maintenance records should contain the following items:
  - a. Line setting tickets;
  - b. Work orders and repair records;
  - c. Preventive maintenance records;
  - c. Vehicle depreciation;
  - e. Equipment specifications; and
  - f. Inspection reports.
  
8. Cost records should contain data in the following categories:
  - a. Vehicles;
  - b. Labor for vehicle maintenance and repairs;
  - c. Parts;
  - d. Inventory;
  - e. Administration; and
  - f. Fuel, lube, coolant, etc.

G. Communication

1. Each bus shall have a two-way communication system capable of providing communication with the operational base, or at least local 911 operators where technologically feasible. All school buses that transport individuals with disabilities should be equipped with a two-way electronic voice communication system that can be used at any point on the vehicle's route.
  
2. It is necessary to keep persons in charge of the system, bus companies, parents and students informed of all operational procedures. The school district or Head Start agency must ensure that the channels of communication are set up so that information can be disseminated quickly and effectively. The school district or Head Start agency must ensure that inquiries, requests, suggestions and recommendations are given prompt and appropriate attention and are handled efficiently. Some of the ways information can be disseminated and their purposes are listed below:



- a. Bulletins: to explain the school district's transportation policy to school and Head Start administrators, teachers, bus companies, drivers, attendants, parents, students and others associated with the operation and to clarify new laws and safety policies so that all persons involved know what is expected of them;
- b. Meetings: to provide an opportunity for those associated with the transportation program to share their views and to help build broad community support for safe transportation;
- c. Public press: to inform parents of policy, route, stop and schedule changes, of the safety record of the operation and positive driver achievement records;
- d. Conferences: to discuss solutions to disciplinary problems with drivers, attendants or monitors, disruptive students and their parents and to review policy decisions affecting drivers, contractors, students and school or Head Start administrators;
- e. Letters: to inform parents of all school or Head Start and state regulations, new routes, etc. and to reply to more urgent inquiries regarding student transportation safety, policy and procedures;
- f. Telephone calls: to provide quick contact between bus drivers and the school or Head Start Center or between parents and the school or Center in the event of urgent or emergency situations;
- g. Radio, television or web page: to inform the public of procedures the schools or Centers will follow in case of severe weather conditions or other natural phenomena, new policies, laws, etc.;
- h. Formal hearings: to be used, as required, for student suspensions from transportation, route challenges, serious complaints against drivers, attendants or monitors, etc.; and
- i. Wireless communication devices: to be used by drivers and attendants only for emergency or business-related communication. (Devices, and particularly cell phones, should not be used for personal communication.)

#### H. Crash Reporting

- 1. Each state's generic traffic collision report for motor vehicle crashes should include at least the information contained in the "Sample Crash Reporting Form" in APPENDIX D.

## I. Transportation Other Than To and From School or Head Start

### 1. School- or Head Start- Related Activity Operations

Each school system or Head Start agency providing activity bus operations should have comprehensive policies and guidelines which delegate responsibility for this function to the supervisor of student transportation. To provide safe and efficient activity transportation, lines of responsibility and authority need to be defined and personnel involved must have an understanding of their respective responsibilities.

In the interest of providing the safest means of transportation available, students should be transported to school- or Head Start-sponsored activities in school buses or allowable alternate vehicles that meet state and federal standards, unless circumstances require an alternate mode of transportation.

These school- or Head Start-related activity trips may include field trips that are extensions of the instructional program, athletic trips, vocational and trade training, volunteer activities and recreational outings, such as dances, picnics and overnight camping trips. These trips range from a few miles to those extending over several days and covering large distances.

The following items need to be considered when developing criteria for activity trip transportation:

- a. Policies and guidelines, including:
  - (1) Purpose of trip (instructional, athletic, students'/spectators' recreation, etc.);
  - (2) Funding source (district or individual school funds, individual charge, parent group, etc.); and
  - (3) Administrative approval (the person who has authority to approve the trip).
- b. A priority guideline should be developed for trip scheduling if all requests cannot be accommodated.
  - (1) Advance notification should allow adequate time for the approval process and for making driver and vehicle arrangements.
  - (2) Methods of travel may include district- or agency-owned or contracted bus, commercial carrier or local transit

equipment, air, boat, rail or combination of the above, private or school passenger automobile, when required by special or unique needs.

**Note:** Operational Guidelines for the use of buses other than school buses are outlined in APPENDIX D.

- (3) A trip request form should include all necessary information from trip arrangements, special equipment, payroll, reimbursement and other local needs. (See APPENDIX D.)
  - (4) Adult chaperones should be required on all activity trips. Responsibilities include passenger control, with the driver having final authority.
  - (5) Discipline and emergency medical procedures should require a trip release to be signed by parents and should include procedures concerning difficult or severe behavioral and medical problems and emergency policies and contacts.
- c. Communication is essential. Drivers, students, chaperones and parents should be made aware of applicable rules and regulations. Parents should have destination information, mode of transportation, names of chaperones, departure and return times, appropriate dress and what the students should bring with them. A signed authorization for student participation from the parent or guardian is important. A detailed itinerary for all persons involved may be advisable. Identification of special medical problems in the event of an emergency en route is necessary.
- (1) Luggage accommodations, if applicable, must be included. A procedure for transporting luggage or equipment prohibited in the passenger compartment by state law and/or local regulations is necessary. Loose luggage or equipment which could cause injury or block passageways should never be transported in the passenger compartment.
  - (2) Policies should detail whether or not out-of-state trips are permitted and, if so, any applicable restrictions. Regulations for states to be visited should be reviewed prior to the trip.
  - (3) Insurance policies should be reviewed or agents contacted to determine adequacy of coverage. This is an absolute

necessity for trips scheduled to another state or country. If vehicles other than district-owned are used, the Board of Education should determine the minimum insurance coverage to be carried. A current copy of the contract or commercial carrier's insurance should be on file with the school district.

- (4) Road and weather checks should be made by the designated person. School transportation personnel from other districts, state patrols, highway divisions and auto clubs are generally cooperative in supplying road information. If warranted, the weather bureau should also be contacted. A planned route and any contingent route for trips should be determined prior to initiation of the trip.
- (5) Contingency plans require policies and procedures that detail persons who have authority to make decisions if the unexpected happens during a trip. Impassable roads, crashes or mechanical breakdowns are examples. Drivers and chaperones should have access to that authority's phone number. It is also advisable to obtain phone numbers of transportation personnel in various communities and school districts where activity vehicles regularly travel. Provisions should include plans for staying overnight if conditions do not permit a safe trip home. It is advisable to develop a mutual aid directory for contact within athletic league boundaries which could provide assistance in the event of mechanical emergencies. Drivers should be trained in procedures and regulations relating to trip crashes.
- (6) Driving hours should be regulated. School districts and Head Start agencies should have regulations based on a common-sense application of the Federal Motor Carrier Safety Regulation 49 CFR 395.3 (15 hours on duty of which no more than 10 hours are driving time; 8 hours continuous off-duty prior to a long trip; no more than 60 hours driving in a week).
- (7) Driver selection and assignment criteria are necessary to avoid conflict and confusion. The criteria should include a driver's knowledge, skill, experience and familiarity with activity trip vehicles. The area to be traveled should also be a consideration. Drivers should be notified at least three days in advance of the trip date. Drivers who drive only activity trips should be tested periodically for driving

ability and vehicle familiarity. They should hold the same license and certification as regular school bus drivers.

- (8) Passenger manifests (a list of all passengers being transported) should be kept by the driver and left with proper authorities at the school or institution.
- (9) Evacuation instruction, including an emergency evacuation drill, or at least verbal instructions, should be given by the driver before each trip. (See APPENDIX D.)

d. Vehicle and equipment:

- (1) The following should be taken into consideration when selecting trip vehicles:
  - (a) Miles to be traveled;
  - (b) Terrain and climate conditions;
  - (c) Number and age group of students;
  - (d) Luggage and equipment requirements;
  - (e) Driver familiarity with the vehicle and route; and
  - (f) Federal Motor Carrier Safety Standards, if contract operated and crossing state lines.
- (2) Consideration should be given for specialized equipment, or other items needed, such as:
  - (a) Luggage storage;
  - (b) Chains (pre-fitted prior to the trip) or sanders;
  - (c) Extra heaters or air conditioning;
  - (d) Public address system;
  - (e) Radio (am/fm, tape deck, two-way) or cellular telephone;
  - (f) Tires, including off-road tread or recaps on the rear axle (recaps on front axle are prohibited);

- (g) Spare tire;
  - (h) A tool kit containing items such as a flashlight, pliers, screwdrivers, de-icer, extra chain tighteners, etc., and additional equipment for an extended trip, as may be recommended by transportation personnel at the destination;
  - (i) Cash for telephone, fuel, bridge tolls, parking fees and personal needs;
  - (j) Emergency telephone numbers and other information; and
  - (k) Global Positioning Systems (GPS), as appropriate.
- (3) Inspection requirements should be the same as for regular route buses, and a detailed check should be made prior to activity trips.
  - (4) School buses shall be prohibited from towing a trailer or any vehicle when students are on board the bus.
- e. Training
- (1) Specialized training should be provided for activity trip drivers. Training should include, but not be limited to, the following:
    - (a) State laws and applicable policies and rules;
    - (b) Familiarity with the activity trip vehicle and its components;
    - (c) Familiarity with specialized equipment and how to use it, including cellular telephone and onboard global positioning system (GPS);
    - (d) Familiarity with local and state trip requirements;
    - (e) Route familiarization, which might include a dry run prior to the trip date, especially if extreme conditions, terrain or road difficulties may be encountered;
    - (f) Discipline procedures on trips;
    - (g) Driving under adverse conditions (night driving, slippery roads or unfamiliar mountainous driving);

- (h) Maps, destination locations and parking areas;
- (i) Parking location, if other than the student destination; and
- (j) Provisions for bus security at the destination.

## 2. Non-Related Activity Operations

### a. Introduction

This sub-section is intended to address the various uses of a school bus for operations other than to and from school and school-related activities.

### b. Use, Procedures and Policies

- (1) The school bus operator, in accordance with state regulations and/or laws governing school bus use, should establish procedures whereby school buses can be scheduled for non-routine use. Such scheduling should not conflict with, or be given priority over, the regular class-related demands for school buses by the school system or Head Start agency.
- (2) The school system or Head Start agency, as part of local government or in cooperation with transportation contractors, may utilize buses during times of community emergency or crisis, when demand for other public vehicles, such as trains and transit buses, is so great as to exceed available supply.

### c. Legal Requirements

- (1) School buses operating on public roads and crossing state and national boundaries must adhere to the rules of the road in the jurisdictions in which they are operating.
- (2) All permits and fees need to be procured in accordance with applicable state and local laws before the trip is undertaken.

### d. Operational requirements

- (1) Vehicle equipment used for activities must be in good working order, well-maintained, and otherwise capable of withstanding the demands of the trip.

- (2) All activity buses and drivers should comply with all applicable state and federal requirements, including Federal Motor Carrier Safety Regulations applicable to inter- and intra-state passenger transportation.
- (3) Aisles and exits must be kept clear and free of blockages at all times.

## J. Air Quality

The school transportation community is supportive of efforts to reduce emissions and improve air quality, particularly for the students served by school bus transportation. In fact, the school bus industry has been at the forefront of environmental improvements and is committed to a continuing involvement and leadership role in improving engine emissions.

An accelerated replacement of older buses with new school buses equipped with the latest emission controls and engine technologies would be ideal. Likewise, retrofitting newer school buses with the latest emission control technologies can help improve air quality, but at additional costs.

While the student transportation industry and other entities work to develop new and increased sources of funds, states and local districts can institute policy that will contribute to improvements in air quality, especially for children.

### 1. Idling Control Measures

- a. States and local districts should develop programs to eliminate unnecessary engine idling...
  - (1) At school site loading and unloading zones; and
  - (2) At school bus stops, located out of traffic during extended wait times.
- b. Consideration should be given to varying climatic conditions within the state or local district and to the individual needs of students with disabilities.

### 2. Driving in Traffic

States and local districts should develop programs to inform school bus drivers of the effects of closely following other vehicles, particularly large commercial motor vehicles, including other school buses, since the exhaust emissions from those other large vehicles can contribute significantly to the air quality inside the school bus.



3. School Bus Utilization
4. School Bus Maintenance Programs

States and local districts should continue to improve the inspection and maintenance programs that have been established, with a renewed attention to factors impacting emissions.

K. Using New Technologies and Products

1. Operators should explore the use of new technologies and products, whenever practicable, to improve the safety, effectiveness, accountability and efficiency of student transportation operations.
2. Current new technologies include, but are not limited to:
  - a. Computerized...
    - (1) Routing;
    - (2) Timekeeping;
    - (3) Activity trips;
    - (4) Student tracking;
    - (5) Employee tracking;
    - (6) Vehicle maintenance; and
    - (7) Training records.
  - b. Automatic vehicle location;
  - c. Global positioning systems (GPSs);
  - d. Electronic pre-trip and post-trip inspections; and
  - e. Electronic fuel dispensers.

**TRAINING OF BUS DRIVERS**

- A. Procedures for selection of school bus drivers should include the following items:
1. An appropriate application form. (See APPENDIX D.)
  2. Written criteria for accepting and rejecting applicants\*;

3. Written notification to all applicants that driving records checks, criminal records checks and drug/alcohol screening will be conducted\*;
4. A check of each applicant's driving record; (Checks of the National Driver Register and the CDL Information System of the appropriate state department of motor vehicles are considered essential\* in the case of an individual who is applying for a position as a school bus driver.)
5. A check through both state and national criminal identification agencies to determine if each applicant has a record of criminal convictions\*.;
6. One or more personal interviews (which can be one of the most important of the selection procedures);
7. Physical examinations and drug and alcohol testing administered in accordance with local, state and federal requirements; and
8. A determination of educational attainment to demonstrate the applicant's ability to follow detailed, written instructions and to be able to record and report data accurately.

\*(**Note:** Driver applicants for Head Start positions **must** be informed in writing of all background checks and other requirements.)

B. Pre-service and In-service Training Program

1. Prior to transporting students, bus drivers should be required to complete a state-approved pre-service training program that includes classroom and behind-the-wheel training to enable safe and efficient vehicle operation.
2. An annual state-approved in-service training should be required.
3. Prior to transporting students with disabilities, the driver should receive appropriate training in compliance with the Individuals with Disabilities Education Act (IDEA).
4. Drivers should receive drug and alcohol education, as required in the Omnibus Transportation Employee Testing Act of 1991.
5. Drivers of Head Start passengers must fulfill pre-service and in-service training requirements, as specified in 45 CFR 1310.
6. Employers of school bus drivers are encouraged to provide ongoing education for bus drivers.

### C. Behind-The-Wheel Instruction

Behind-the-wheel instruction should be given in the same type and size bus the driver will be operating. When a driver is expected to operate more than one size and type vehicle, instruction should be related to the specific handling characteristics of each. All instruction should include:

1. Familiarization with the bus and its equipment;
2. Procedures for performing pre-trip and post-trip vehicle inspections;
3. Techniques for safe driving, including mirror use and adjustment, smooth starts and stops, shifting, turning, and backing;
4. Defensive driving skills;
5. Techniques for reference point driving;
6. Procedures for loading and unloading students at bus stops, including moving the bus only after all children are safely seated after loading and out of the danger zones and are at least 12 feet from the sides of the bus, are at least 12 feet from the rear of the bus and are at least 12 feet in front of the bus;
7. Procedures for railroad crossings as recommended in APPENDIX D and other specialized driving requirements for school bus operations;
8. Techniques to identify and avoid practices that result in driver-related vehicle abuse;
9. Procedures for en route emergencies, including driving emergencies, emergency evacuations, and use of emergency equipment, as described in APPENDIX D;
10. Guidelines for safely running a route, including entrance to and departure from the bus garage and yard, following a route sheet or map, use of global positioning systems (GPSs), entrance to and departure from school zones, appropriate use of wireless communication systems, mechanical difficulties and breakdown;
11. Procedures for fueling buses and handling/preventing fuel spills; and
12. Laws, policies and procedures specific to activity trips, including interstate transportation regulations.

D. Physical/Mental Preparedness

All school bus drivers should be prepared both physically and mentally each day to perform adequately the following duties:

1. Operating the vehicle in a safe and efficient manner;
2. Conducting thorough pre-trip and post-trip inspections of the vehicle and special equipment, including required documentation;
3. Ensuring the safety, welfare and orderly conduct of passengers while in the bus;
4. Handling emergency situations in accordance with generally accepted operating procedures;
5. Communicating effectively with school staff, students, parents, law enforcement officials and the motoring public;
6. Completing required reports;
7. Completing required training programs successfully;
8. Providing maximum safety for passengers during loading and unloading;
9. Wearing driver's seat belt whenever the bus is in motion; and
10. Checking at the end of the route and at the bus storage location to ensure that all students have disembarked from the bus.

E. Evaluation

School bus drivers should be evaluated at regular intervals. These evaluations may include the following items:

1. Written test;
2. Road performance checks; and
3. Evaluation interviews.

## **TRAINING OF BUS ATTENDANTS**

A. Procedures for selection of bus attendants should include the following items:

1. An appropriate application form (as provided in APPENDIX D);

2. Written criteria for accepting and rejecting applicants\*;
3. A check through both state and national criminal identification agencies, to determine if the applicant has a record of criminal convictions\*;
4. One or more personal interviews (which can be one of the most important of the selection procedures); and
5. A determination of educational attainment to demonstrate the applicant's ability to follow detailed, written instructions and be able to record and report data accurately.

\*(**Note:** Head Start attendant or monitor applicants **must** be informed in writing of all background checks and other requirements, as specified in 45 CFR 1310.)

B. Pre-service and In-service Training Program

1. Prior to transporting students, bus attendants should be required to complete a state-approved pre-service training program that includes classroom and in-the-bus training in order to enable safe, efficient and effective student transportation. Training should include, but not be limited to, the following topics:
  - a. The bus and its equipment;
  - b. Use of emergency exits;
  - c. Safe loading and unloading of students at their stops and securement of passengers, as may be required;
  - d. Student management training and policy training, including state and federal regulations related to the transportation of students with disabilities, consistent with those required for school bus drivers;
  - e. The safety, welfare and orderly conduct of passengers while in the bus;
  - f. Handling emergency situations in accordance with generally accepted operating procedures;
  - g. Effective communications with school or Head Start staff, students, bus drivers, parents, law enforcement officials and the motoring public;
  - h. Completion of required written reports;

- i. Checking at the end of the route and at the bus storage location to ensure that all students have disembarked from the bus; and
    - j. Other topics included in the bus attendant's manual/handbook.
  - 2. Participate in annual state-approved in-service training, if available.
  - 3. Prior to transporting students with disabilities, the bus attendant should receive appropriate training in compliance with the Individuals with Disabilities Education Act (IDEA).
  - 4. Bus attendants (monitors) who assist with the transportation of Head Start passengers must fulfill pre-service and in-service training requirements as specified in 45 CFR 1310.
- C. In-the-Bus Training
  - 1. Familiarization with the bus and its equipment.
  - 2. Procedures for performing pre-trip and post-trip inspections.
  - 3. Procedures for loading and unloading passengers, passenger securement and emergency evacuation, as may be required.
- D. Physical/Mental Preparedness
- E. Evaluation
- F. Bus attendant, Special Education (See TRANSPORTATION FOR STUDENTS WITH DISABILITIES AND SPECIAL HEALTH CARE NEEDS, driver/attendant.)

## **TRAINING OF MAINTENANCE AND SERVICE PERSONNEL**

- A. Staffing
 

Adequate staff should be employed to perform maintenance functions on a timely basis consistent with safe transportation practices.
- B. In-service Training Program
  - 1. The transportation system should make available to maintenance and service personnel the necessary maintenance and service publications for the equipment serviced.
  - 2. The transportation system should arrange at regular intervals for pre-service and in-service training for maintenance and service personnel.

Maintenance personnel should be required or encouraged to attend state-sponsored or other approved workshops or training institutes.

3. Training should include instruction in the following areas:
  - a. Preventive maintenance procedures;
  - b. Repair and/or installation procedures for each type of fleet vehicle and its varied equipment;
  - c. Procedures for specialized equipment;
  - d. Inspection of the vehicle and its equipment;
  - e. Recovery procedures for vehicles involved in a crash or breakdown;
  - f. Preparation and retention of maintenance records;
  - g. Maintaining planned parts and equipment inventory;
  - h. Establishment of parts inventory control procedures;
  - i. Repair and installation of adaptive equipment; and
  - j. Environmental compliance.
4. Vehicle maintenance and service personnel should be encouraged to receive certifications in all areas in which they perform work.

## **ROUTING AND SCHEDULING**

It is necessary to procure a map of the area served by a particular school, school system or Head Start program in order to establish bus routes that will adequately meet the needs of students in a particular area. Information on road conditions, railroad crossings and other factors that might affect the particular operation should be recorded, along with the location of homes and the number of school-age children in each household. (See also “Identification and Evaluation of School Bus Route and Hazard Marking Systems” in APPENDIX D.) Satisfactory school bus stops must be identified along streets and highways where buses can travel with the least amount of risk. The number of students to be transported and the distance to be traveled are primary factors in allocating equipment for a particular area. Students should be assigned to specific stops according to walking distances, grade level and the school or Head Start Center attended. Consideration should be given to the distances between stops to comply with the minimum distance required to activate the red and amber lighting systems.

- A. Bus routes reflect an infinite number of routing techniques, including the following examples:
1. A circular route circumscribes an area by using different roads on out-going and in-coming trips. It has the advantage of equalizing time in transit for transported students, since the first child on in the morning is the first child off in the evening.
  2. A shoestring route extends from the school to some terminal point in the district. If the bus is stored at the school, the same road or roads may be used on the out-going and in-coming trips; consequently, children are always traveling more or less directly toward the school.
  3. A feeder route extends from a point farther out in the district to a transfer point on the main route. This method may be advisable for one or more of the following reasons:
    - a. To limit the use of large buses to improved roads;
    - b. To reduce travel time on the main route; or
    - c. To provide some form of transportation on roads which at times may be impassable by larger, more desirable motor vehicles.
  4. A shuttle route extends between two or more school buildings. Such routes are often required for the transfer of students in districts operating two or more schools.
  5. Retracing routes requires the bus to travel over the same route in the same direction and may be used to eliminate the need for students to cross the roadway. It may also equalize time in transit for transported students, since the first child on in the morning is the first child off in the evening.
- B. Emergency Routes should be established and utilized in all school systems when weather or road conditions dictate that it is not safe to travel on other than hard-surfaced roads. Announcements can be made by radio or other means when such routings are to be used.
- C. Computer-assisted routing and scheduling, which require the use of a computerized database of students, streets and bus routes, is a key part of the routing operation. Student records are computerized, and downloading student names, addresses, school names and grades is a routine task. Some student information systems even incorporate bus routing information. The key is for transportation staff to have quick access to the location of students to be used in establishing bus stops.



Many routing systems, through a geographic information system (GIS) component, have optimization features that allow the system to create bus routes based on the locations of students. It is important to make sure that before implementation, transportation staff analyze any computer-generated routes, because they will almost certainly need some level of adjustment. Computer-assisted routing can help to generate a more efficient routing system than a completely manual process. A computer system can also be of use in providing information needed to stagger bell times in order to share buses among schools or Head Start Centers.

The same information that is needed for bus routing can be very useful in school district planning. The grades and locations of students displayed in a graphic format is invaluable to school administrators as school district lines are redrawn or new schools are opened. Accessing this information from a routing system also may provide a side benefit of involving the transportation staff in the planning process.

#### D. Methods of serving bus routes

1. The “single-trip plan” involves a morning and an afternoon trip by one bus on each route. This form of service is well adapted to sparsely populated areas. It also meets the needs of schools where the instructional program requires both elementary and secondary students to arrive at the same time, or where time required for the route prohibits additional assignments.
2. The “double-trip plan” calls for each bus to cover two different routes in the morning and afternoon. This plan is suited to districts of relatively dense population where distances are not great. As children of all grades may be carried on each trip, program adjustments in the instructional schedule are necessary to avoid idle waiting time at the school. If these adjustments can be made without sacrificing the interests of the children, the double trip may be economical by requiring fewer buses.
3. The “multiple trip plan” or “dual-trip plan” calls for more than two trips each morning and afternoon by each bus. This arrangement is feasible only where route distances are relatively short or time differences between locations are great. High school students, for example, may be brought to school on the first morning trip, with elementary children arriving on the second trip. In the afternoon, the elementary children should be brought home first if it is desired that the elementary day be shorter than the high school day. Districts whose program requires a day of equal lengths for both groups may transport the high school students on the first trip in the morning and return them on the first trip in the afternoon.

## E. Survey and stops

The student transportation director should conduct a survey for the purpose of identifying factors that might indicate the need for a route change. After the survey is completed, driving over the route in the same equipment that will be used in the actual operation, the director should require a time study. The driver(s) who will operate the bus(es) over the route(s) should regard the trip as a dry run. All scheduled stops and times between stops should be indicated. This data, if accurately obtained, will permit the development of a schedule which probably will need little revision once it is placed into effect.

After the route has been established, a schedule showing individual stops should be available in the bus for the information of substitute drivers. Requests for new or additional service should be investigated thoroughly before a change is made. Stops should be established only after thorough investigation has revealed the location to be the most desirable in the area. It is considered poor practice to negotiate a U-turn on main arteries of traffic even though provisions for such turns may have been made. The projection of the rear end of the bus into inside traffic lanes from medians that are too narrow to accommodate bus length often creates traffic interference that places the lives of transported students in jeopardy. Stops should always be located at a safe distance from the crest of a hill or curve to allow motorists traveling at the posted speed to stop within the sight distance.

Each state should establish a uniform set of procedures for drivers signaling students to cross the street upon which the bus is stopped.

Additional precautions should include, but may not be limited to, the following:

1. Plan routes that will permit optimum and effective student safety, program efficiency and operational economy.
2. Specified criteria should be used when selecting stops. Criteria examples include, but may not be limited to, the following:
  - a. Visibility;
  - b. Safe waiting distance from roadway;
  - c. Proximity to intersection;
  - d. Adjacent property;
  - e. Line of sight distance to the stop by approaching traffic from any direction; and

- f. Ability to add signage and/or warning devices to alert oncoming traffic of a stop ahead.
3. On highways divided into separate roadways and highways with three or more marked traffic lanes, fleet operators, schools and Head Start Centers should design bus routes that serve each side of the highway so that students do not have to cross the highway unless there is a traffic control signal or an adult crossing guard within three hundred feet of the bus stop to assist students while crossing such multiple-lane highways. A bus shall never be routed such that students are required to cross lanes of traffic in which vehicles are not required by law to stop for a school bus displaying red lamps and stop sign.
4. Determine the location and destination of all students to be transported.
5. For each general education route, late route or similar home-to-school route, drivers shall be provided with a route sheet or manifest, with stops sequenced by, or under the direction of, the transportation director, containing the following elements:
  - a. The name and address of all students in the bus(es);
  - b. The location or written description of each stop (where an intersection is involved, the compass orientation of the stop location within the intersection) and an optional map for orientation purposes;
  - c. Scheduled arrival times for each pick-up and drop-off point;
  - d. Blank lines adjacent to the scheduled arrival time in which the driver may notate his/her **actual** arrival time;
  - e. The routine crossing status (i.e., “cross” or “no-cross”) of each student on the route;
  - f. The school of attendance (or destination) of each student;
  - g. Shuttle or transfer information for students, if applicable;
  - h. Identification of students with dormant medical problems that may require specific actions from the driver in the event the problem becomes active; and
  - i. An updated copy of the route sheet or manifest should be kept at the transportation and attendance offices.

6. Every school, school district, Head Start or other agency should develop age-appropriate training for children who ride buses or other passenger vehicles to and from attendance centers and on activity trips. Instruction should include, but not be limited to the following:
  - a. Travel to and from bus stops;
  - b. Roadway crossings;
  - c. Loading and unloading procedures;
  - d. Behavior at bus stops;
  - e. Behavior on board vehicles; and
  - f. Use of applicable passenger restraints and other safety items identified by transportation safety experts.

Instruction should begin as soon after the beginning of the school or program year as practicable and should be reinforced as often as necessary to assure optimum understanding by the respective passengers.

7. Provide parents or guardians of all students with the driver's name, bus number, pick-up and return times, school closing information, school calendar, procedures to challenge routing decisions, etc.
8. Determine the advisability of utilizing computer-assisted route scheduling.

## **MAINTENANCE OF EQUIPMENT**

- A. Teamwork and written policies are essential to a well-organized maintenance program.
  1. Strong and reasonable school bus maintenance policies and appropriate training that provide efficient guidelines for the transportation supervisor, maintenance personnel, and operators of the vehicles should be adopted.
  2. Such policies should include the maintenance responsibilities of each person involved and should provide for a planned preventive maintenance program.
- B. Preventive maintenance is a carefully organized system of inspections at regular mileage or time intervals combined with the immediate attention to all reported defects.

1. Manufacturer's service manuals and warranty protection guidelines, as well as state inspection guidelines, contain valuable information for successful preventive maintenance programs. These instructions and procedures should be followed carefully for maximum efficiency and safety in fleet operation. Vehicle and component manufacturers (transmission, electrical, occupant restraints, etc.) offer training for fleet technicians. Those interested in efficient operation will take advantage of these training programs.
  2. Objectives of a planned maintenance program:
    - a. Keeping the vehicles in safe and efficient operating condition;
    - b. Preventing road failures;
    - c. Conserving fuel;
    - d. Lowering maintenance costs by reducing the need for major repairs or overhaul;
    - e. Extending the useful life of the vehicle and its components; and
    - f. Enhancing vehicle appearance.
- C. School districts or private contractors should develop a system whereby written communication would allow interchange and feedback relative to maintenance work needed and maintenance work completed. An efficient system should include:
1. Driver's report form to initiate needed maintenance;
  2. Technician certification of completed work;
  3. A method for permanently recording repairs and the maintenance history of each vehicle and special equipment; and
  4. Inspection by the appropriate state agency or its designee.

## **EMERGENCY AND RESCUE PROCEDURES**

A Guideline Manual For School Bus Involvement was developed and disseminated to each state director of transportation for reproduction in the respective states. Distribution of the manual was intended for police, fire and ambulance personnel, emergency medical technicians and any other entity designated to respond to a school bus crash, emergency or disaster. (Head Start agencies may contact their respective state directors of transportation for copies.)

This manual is a reference to be used by school systems (and can be used by Head Start agencies) in developing their own specific emergency plans. Copies of the school system's (or Head Start agency's) plan should be carried in each bus. This plan should be developed in cooperation with the personnel in those agencies that will render service during emergencies. The school or Head Start transportation director, school and Center administrators, teachers, drivers, attendants, maintenance and service personnel, students and others should be instructed in the procedures to be followed in the event of the following situations:

A. Crashes

1. How to evacuate and control students;
2. How to evaluate the need for medical assistance;
3. How to get help from the police, the fire department and the garage;
4. How to collect and record data essential to the preparation of the required crash reports and an operational plan to provide two-way communication with parents and/or guardians which is imperative; and
5. How to prevent further crashes.

B. Sudden disability of the driver

Procedures for handling situations resulting in the fatal injury or disability of the bus driver should be established and communicated to appropriate persons. A list that includes the name of the bus operator, emergency telephone numbers, names of students assigned to the bus and the special needs of students should be in the bus.

C. Bus breakdown

The emergency plan should cover procedures for the following events:

1. Securing the bus;
2. Controlling the passengers;
3. Diagnosing the cause(s) of the bus breakdowns;
4. Notifying school or Head Start officials;
5. Recovering the disabled school bus; and
6. Providing replacement transportation for passengers.

D. Inclement weather conditions

The emergency plan should provide procedures for actions to be taken in the following events:

1. When schools or Head Start Centers are to be closed;
2. Who is to make such decisions;
3. How decisions are to be relayed to parents, students, school or Head Start officials and staff (including teachers and cafeteria managers), drivers, contractors, maintenance and service personnel, the news media and others; and
4. How to react to such natural phenomena as floods, hurricanes, tornadoes, earthquakes, tsunamis, etc.

E. Other types of emergency situations

The emergency plan should include communication norms, data collection and stress reduction and should cover such conditions and events as the following:

1. Defense/disaster drills;
2. Strikes or other job action by school staff, teachers, drivers or contractors;
3. Road or bridge washouts and landslides that might block school bus routes;
4. Bus hijacking;
5. Weapons on board or at bus stops;
6. Unauthorized boarding;
7. Student health emergencies;
8. Student fights; and
9. Suspected explosives on board or at bus stops.

## **EVALUATION OF THE STUDENT TRANSPORTATION SYSTEM**

- A. Each school district or Head Start agency should have a plan for evaluating its student transportation program. Such evaluations should enable school districts or Head Start agencies to:

1. Verify compliance with rules, regulations and laws;
2. Audit the efficiency of program service;
3. Monitor operational economy;
4. Ensure the safety of the program in operation;
5. Improve the quality of service; and
6. Verify student knowledge of school bus rules and procedures.

B. Major types of evaluations include the following:

1. Informal reviews by district personnel;
2. Formal evaluations by:
  - a. A private consultant;
  - b. A state agency; or
  - c. PRISM (Program Review Instrument for Systems Monitoring of Head Start and Early Head Start Grantees).
3. Periodic evaluations:
  - a. Monthly;
  - b. Annually; and
  - c. Biennially.

C. Areas subject to evaluation include:

1. Board of Education or Head Start policies;
2. Routing procedures and processes for route hazard analysis;
3. Types of service provided;
4. Financial obligations;
5. Quality of service;
6. Training of staff and students;



7. Maintenance of buses, other vehicles and equipment;
8. Record keeping systems; and
9. Other areas as determined by state and local policy.

## **SCHOOL SITE SELECTION AND FACILITY PLANNING**

When school or Head Start sites are being selected, consideration should be given to the safety of the students riding school buses. School buses will be required to utilize the roads in and around the school site, plus public roadways leading into and away from the school area. High-density traffic flow near exits and entrances should be avoided. Proper site selection, ingress and egress and facility planning for improved transportation are extremely important. (See APPENDIX D.) More specifically, school officials should provide:

- A. Separate and adequate space for school bus loading zones;
- B. Clearly marked and controlled walkways through school bus loading/unloading zones;
- C. Traffic flow and parking patterns for the public and non-bused students separate from the school bus loading zone.
- D. A designated loading area for passengers with special needs, if required;
- E. An organized schedule of loading areas with stops clearly marked;
- F. A loading and unloading site to eliminate the backing of transportation equipment;
- G. Written procedures for evaluating each school site plan annually; and
- H. Appropriate signage.



**SCHOOL  
TRANSPORTATION  
SECURITY AND  
EMERGENCY  
PREPAREDNESS**



## **SCHOOL TRANSPORTATION SECURITY AND EMERGENCY PREPAREDNESS**

### **School Transportation Security and Emergency Preparedness**

Each school day almost 20 percent (50 million) of the United States' population is located in our Nation's schools. Approximately half of these children (25 million) use a school bus for transportation to and from school each day. Additionally, millions of children ride school buses each day for school activity trips.

A review of past terrorist actions and statements makes it clear that buses, and particularly school buses, are viable terrorist targets.

Until recently, school transportation has been centered on two main objectives: safety and efficiency of school bus operations. Since September 11, 2001, transportation system security has been added into the equation. In addition to the threat from foreign and domestic terrorist groups, the school bus driver and passengers may be targets of violence from students, unauthorized boarders and others outside the school bus. School transportation professionals must give school transportation security and emergency preparedness at least the same level of commitment that has been given to safety and efficiency.

The information in this segment is not intended to be a comprehensive guide on school transportation security or to supercede any federal, state or local policies and plans. Rather, the purpose of this information is to assist school transportation officials and school transportation service providers when establishing or revising their state or local policies and plans concerning school transportation security.

### **Types of Planning and Policy Considerations**

- A. Do you have a district security policy and crisis response plan including procedures that include transportation personnel, equipment and facilities? Does the plan/policy coordinate with procedures in the school buildings?
- B. Has a transportation system security and emergency procedures assessment been performed?
- C. Does the plan/policy contain information on threat and vulnerability identification?
- D. Does the planning and policy process include appropriate stakeholders, e.g., first responders, law enforcement, fire department and media (print, radio, television, etc.)?
- E. Are the plan/policy and procedures communicated to all personnel?
- F. Are the procedures of the plan/policy routinely tested with means for assessment, evaluation and improvement at least annually?

- G. Does the plan/policy provide information on how to recognize suspicious people, activities, packages and devices?
- H. Does the plan/policy require security inspections of vehicles and facilities?
- I. Does the plan/policy address commonly used terrorist weapons, e.g., improvised explosive devices, chemical, biological and radiological agents?
- J. Does the plan/policy contain directives on incident management and command?

### **Security Readiness**

Vigilance, which requires an awareness of vulnerabilities, is the first step to better security. In order to determine the threat level to the student transportation system, a system-wide security audit should be conducted. The audit should include participation of school administrators, local and state police and medical and hospital administrators. The audit will help to identify weaknesses and strengths within the operation. The audit should begin at the front line of any transportation system -- the driver -- and continue up through all levels of the organization. After completing the security audit, appropriate plans/policies and procedures can be developed and implemented.

### **Security Audit**

A security audit should consider the following security issues:

- A. Review current security plans/policies and procedures by asking the following questions:
  - 1. What security plans/policies and procedures exist?
  - 2. Do they address facilities, equipment, personnel and passengers?
  - 3. Have these plans/policies and procedures ever been used?
  - 4. Were the plans/policies effective?
- B. Review existing lines of communication by asking the following questions:
  - 1. What lines of communication exist within the operation?
  - 2. Do they interrelate with local law enforcement, fire and emergency services?
  - 3. Are they clearly defined and documented?
  - 4. Are all employees trained and familiar with them?
  - 5. Have these lines of communication been tested and proven?
  - 6. Is there an alternate communication plan if the normal systems are unavailable?
  - 7. Were the communications effective, as tested?

C. Review personnel security by asking the following questions:

1. Are all employees and visitors required to wear identification badges? Do they wear them?
2. Is there a “sign in/sign out” system?
3. Are all employees required to wear uniforms? Do they comply?
4. Are students registered on a particular bus?
5. Are drivers provided with a list of riders?
6. Are there procedures for accounting for each individual student, especially on activity trips?
7. Do evacuation plans exist?
8. Is there a designated place to relocate staff or students?
9. On activity, field or extracurricular or school-chartered bus trips, are students instructed in safe riding practices and on the location and operation of emergency exits?

D. Review operational security by asking the following questions:

1. Are all vehicle doors, hatches and compartments locked when vehicles are unattended? Are keys left in the bus or ignition?
2. Are facilities equipped with camera or video surveillance equipment and intrusion alarms?
3. Do plans/policies and procedures for locking doors and gates exist? Are the codes or combinations changed regularly?
4. Are off-site parking locations secure?
5. Is the exterior of the transportation facility, administration building and maintenance facility secure?
6. Is the bus yard secure?
7. Are fencing or walls, vehicle or personnel gates and lighting available?
8. Is there surveillance equipment?
9. Is the interior, i.e., all rooms, storage areas and closets of the transportation facility, administration building and maintenance facility secure?
10. Are roofs secure?
11. Are all bus routes safe and secure?
12. Where are buses staged during the route if there is a layover period?
13. Are buses left unattended at schools during layover periods?
14. Are all schools and school parking areas safe and secure?
15. Are commonly used school activity sites safe and secure?
16. Do drivers leave the bus to watch the activity?
17. Is there a pre-trip inspection prior to departure for home?
18. Do computer and communications systems exist?
19. How is access to computers or systems controlled? What are their limitations?
20. How can computers be compromised, and if they can be compromised, what can be done to prevent it?

21. Is the communication system (e.g., two-way radio, land telephone line, cellular telephone, etc.) capable of recording?
22. Is there a code system to identify emergencies or threats?
23. Do emergency back-up systems for information and communication exist? What are their limitations?
24. How can emergency back-up systems be compromised, and if they can be compromised, what can be done to prevent it?
25. Are the back-up systems stored off site? Are they secure?
26. Is there a plan available that does not require electrical energy?

### **Security Plans/Policies and Procedures**

The audit should indicate any gaps in existing plans/policies and procedures. Also, board and administration-approved security plans/policies and procedures should be developed. These plans/policies and procedures must be supported and enforced by the entire transportation organization. Plan/policy recommendations should include, but not be limited to the following:

- A. Consider the security interest of students when establishing district plans/policies which make routes, schedules and locations available to parents and guardians on the internet.
- B. Establish board-approved plans/policies on the use of employee uniforms and identification badges and student registration (bus passes). Consideration should be given for a means to appropriately identify that a student may be met by a parent, guardian or other authorized person.
- C. Establish board-approved plans/policies on property security, e.g., locked doors and gates, security cameras, alarms, employee photographs, public entry, etc.
- D. Establish communication procedures regarding the use of two-way radios, cell phones, VHF radios, combination phones, etc.
- E. Establish command and control procedures that include a chain of command, and specify the decision-makers in any given situation.
- F. Establish emergency or security reporting procedures, e.g., who the driver calls in a security threat or emergency. Determine what circumstances constitute a security threat or emergency and when a driver must report a security threat or emergency to a supervisor.
- G. Establish a board-approved plan/policy regarding regular system safety and security training.
- H. Establish a board-approved plan/policy for enforcing safety and security policies and procedures.
- I. Establish post-trip practices before the driver leaves the vehicle.



## **Transportation Personnel and Their Training**

School transportation already focuses on safety training. A security audit likely will indicate a need for renewed and expanded focus on security—especially extreme threats. Security training should be a primary element of plans/policies and procedures. Individual awareness is the single best weapon for preventing crime and increasing personal and business security. Any person armed with awareness is less likely to become a victim or allow a crime to be committed. Armed with awareness, most school bus drivers and administrators can either eliminate or significantly reduce property losses and crime. While not the primary goal of a good security program, it is highly likely that routine vandalism and crime will be reduced.

Drivers should be thoroughly familiar with their vehicles, their students, the area and conditions on their routes. They should have a thorough knowledge of the operational plans/policies, procedures and training on possible threats. Armed with this knowledge, drivers can better assess the level of threat in any given situation and respond according to established plans/policies.

### **Suggested Training Topics:**

#### **A. Plans/Policies and Procedures:**

1. What to do in case of emergencies or an increase in security threat;
2. How to use available communication systems;
3. What are the rules for hostage situations;
4. How to conduct security inspection of vehicles (similar to basic bus pre-trip safety inspection); and
5. How to respond to threats of violence from students, unauthorized boarders and others outside the school bus.

#### **B. Identification:**

1. How to determine the threat level;
2. How to identify suspicious, criminal or terrorist activity;
3. How to identify suspicious people, packages or devices;
4. How to identify illegal entry (structure or vehicle); and
5. How to identify and respond to Improvised Explosive Devices (IED).

#### **C. Response and Reports:**

1. How to respond to shootings or snipers;
2. How to respond to fights or disturbances;
3. How to respond to vandalism or property damage;
4. How to respond to child abductions, sexual predators or child custody issues; and
5. How to respond to threats of violence from students, unauthorized boarders and others outside the school bus.

Training processes should include the use of drills and table top exercises to test and practice the plans/policies and procedures.

### **School Bus Security Equipment / Feature Considerations**

- A. Global Positioning System technology;
- B. Silent alarm on two-way communication system (e.g., “panic button”);
- C. Flashing front and rear marker identification lamps to signal predetermined emergency message (e.g. hostage, intruder on board, etc.);
- D. Name of school district and identification number on roof;
- E. Ability to lock entrance (service) door, emergency door(s) and roof hatch(s); and
- F. A reinforced entrance (service) door to prevent forced entry into the bus.

### **School Bus Equipment Guide for Law Enforcement / Fire Department Personnel**

It is recommended that a ‘digital library’ and specification sheet for each type of school bus or other vehicle used for student transportation be created, maintained and updated as equipment is obtained or retired. The equipment guide should be electronically available via private URL site or other readily available means for law enforcement, fire department, first responders, etc.

Recommended contents are:

- A. Identification of each type of school bus:
  - 1. Digital pictures depicting front, rear, sides and interior views; and
  - 2. Year of manufacture, name of manufacturer and bus type.
- B. A specification sheet accompanying each picture which should include:
  - 1. Bus length, width, height and gross vehicle weight;
  - 2. Fuel type, tank location and capacity;
  - 3. Type of powertrain, engine type/manufacturer and transmission type/manufacturer;
  - 4. Battery type and location;
  - 5. Entrance/Exit locations/type and method of operation;
  - 6. Emergency exit locations and their operation, denoting if the exit operates from the inside, outside or both;
  - 7. Window glazing grade, glazing rating, and degree of tint for windshield, side windows and rear windows;
  - 8. Communication system type, location and operation;
  - 9. Presence and location of specialized equipment (wheelchair lift, ramp, oxygen bottles, respirators, storage compartments, etc).;
  - 10. Type of audio or video monitoring equipment, including method of operation;
  - 11. Chart of the seating floor plan including location of entrances/exits; and
  - 12. Bus body construction, type/grade of materials.

## Resources

Department of Homeland Security, [www.dhs.gov](http://www.dhs.gov)

Transportation Security Administration, [www.tsa.gov](http://www.tsa.gov)

Federal Bureau of Investigation, [www.fbi.gov](http://www.fbi.gov)

Federal Emergency Management Agency, <http://www.fema.gov/>

U.S. Department of Education, [www.ed.gov](http://www.ed.gov)

State Departments of Education, [www.doe.state.in.us/htmls/states.html](http://www.doe.state.in.us/htmls/states.html)

U.S. Department of Transportation agencies, [www.dot.gov](http://www.dot.gov)

National Highway Traffic Safety Administration, [www.nhtsa.dot.gov](http://www.nhtsa.dot.gov)

Federal Highway Administration, [www.fhwa.dot.gov](http://www.fhwa.dot.gov)

Federal Transit Administration, [www.fta.dot.gov](http://www.fta.dot.gov)

Federal Motor Carrier Safety Administration, [www.fmcsa.dot.gov](http://www.fmcsa.dot.gov)

Highway Watch Program, [www.highwaywatch.com](http://www.highwaywatch.com)

Highway Watch Program, Information Sharing and Analysis Center, [www.highwayisac.org](http://www.highwayisac.org)



**TRANSPORTATION  
FOR STUDENTS  
WITH  
DISABILITIES AND  
SPECIAL HEALTH  
CARE NEEDS**



## **TRANSPORTATION FOR STUDENTS WITH DISABILITIES AND SPECIAL HEALTH CARE NEEDS**

The purpose of this section is to recommend standard policies, procedures and guidelines for persons entrusted with the responsibility of managing transportation for students with disabilities. The term “*special education*” means, “specially designed instruction to meet the unique needs of a child with a disability.” When transportation is required to provide such instruction, it is considered a “related service.”

As part of the mandate of a free appropriate public education, “Related services” are required when determined necessary to assist a child with a disability to benefit from special education. Transportation as defined in The Individuals with Disabilities Education Act (IDEA) includes:

1. Travel to and from school and between schools.
2. Travel in and around school buildings.
3. Specialized equipment (such as special or adaptive buses, lifts, and ramps), if required to provide special education for a child with a disability.

The guidelines, policies and procedures recommended, though general in nature, do contain adequate information to guide those persons responsible for student transportation in developing an action plan for the safe delivery of transportation services for students with disabilities.

This section reviews the current laws governing special transportation related to the individualized education program (IEP) process, recommended staff training and policy development.

The transportation administrator and pertinent staff shall become familiar with the following laws, guidelines, policies and procedures:

### **LAWS AFFECTING TRANSPORTATION FOR STUDENTS WITH DISABILITIES**

#### **A. Laws**

1. It is possible for a school district to be required to provide specialized transportation services to a student with disabilities who is not in special education. Section 504 of P.L. 93-112, of the Rehabilitation Act of 1973, states in part: “No otherwise qualified disabled individual in the United States shall, solely by reason of his handicap, be excluded from participating in, be denied the benefits of, or be subjected to discrimination under any program or activity receiving federal financial assistance.” In general terms, Section 504 of P.L. 93-112 (1), part of the Rehabilitation Act of 1973, “requires that all students with disabilities

(regardless of age) are eligible for a free appropriate public education.” It also requires the facility, services and activities provided to the disabled be comparable with those provided to the non-disabled, and that students with disabilities must have an equal opportunity for participation in any nonacademic and extracurricular services and activities provided by a school district.

2. Education for All Handicapped Children Act. Congress passed P.L. 94-142, in 1975, and regulations were promulgated by implementation of Part B of the Education for All Handicapped Children Act, effective October 1, 1977. A free appropriate public education (FAPE) is required for all students deemed disabled who are determined capable of benefiting from special education, and who meet specific age limits. While federal law had specified ages 5 through 21, the age range changed to 3-21 with the 1990-1991 school year. Some states and court rulings require service to extend ages from birth to beyond 21 years.
3. The reauthorization of the Education for All Handicapped Children Act of 1975, changed the name to Individuals with Disabilities Education Act (IDEA). P.L. 101-476, passed in 1990 and is also known as the Education of the Handicapped Act Amendments of 1990. This reauthorization increased the number of related services from 13 to 17. It did not change transportation’s status as a related service. The reauthorization did not change the original definitions of transportation that were listed in the Education for All Handicapped Children Act.

**Note:** For transporters, the “Non-Academic Services” section, under the Free Appropriate Public Education component of IDEA requires the public agency to “provide non-academic and extracurricular services and activities in such manner necessary to afford children with disabilities an equal opportunity for participation in those services.” One of the ways to access those non-academic services is transportation. This continues the emphasis to integrate children with disabilities as much as possible with children without disabilities.

B. Characteristics/Conditions:

To be disabled under IDEA, a student must have certain characteristics that adversely affect educational performance, and therefore require special education and related services. The disabilities are defined in the IDEA under Part B Regulations. They appear in 34 Code of Federal Regulations (CFR), Part 300, and Sections 300.7 to 300.18, Children with Disabilities. The terms will be listed in this section as they appear in the CFR. The definitions can be found in APPENDIX E.

1. Autism



2. Deaf-Blindness
3. Hearing Impairment/Deafness
4. Mental Retardation
5. Multiple Disabilities
6. Orthopedic Impairment
7. Other Health Impairment
8. Emotional Disturbance
9. Specific Learning Disability
10. Speech and/or Language Disability
11. Traumatic Brain Injury
12. Visual Impairment/Blindness

### **INDIVIDUALIZED EDUCATION PROGRAM (IEP) - INDIVIDUALIZED FAMILY SERVICE PLAN (IFSP) PROCESS**

The IDEA Amendments of 1997 state that “The State or Local Education Agency (LEA) shall ensure that all of the child’s special education and related services needs that have been identified through the evaluation described in paragraph (b)(1) of this section are appropriately addressed...

a) Each public agency shall ensure that a full and individual evaluation is conducted for each child being considered for special education and related services under Part B of the Act:

- (1) To determine if the child is a ‘child with a disability’ under Sec. 300.7; and
- (2) To determine the educational needs of the child.”

The IEP team is the formal group that designs a student’s educational program, establishes goals and objectives and determines the related services that are necessary for a student to access special education. When transportation as a related service is considered, transportation staff, as related service providers, must be included in the IEP process to address safety and feasibility of various transportation options.

Legal Considerations: By law, this committee must consider several issues related to the student’s educational program. When transportation is considered as a related service, consideration needs to be given to the Continuum of Transportation Services available to students with disabilities, since there are a number of questions that must be addressed. Although most considerations are based on determining the Least Restrictive

Environment (LRE) for the student (Refer to the Continuum of Transportation Services in APPENDIX E.), safety issues for the student must also be considered.

The Individualized Education Program: A written statement of services a student is to receive. Because the IEP can only be changed by the IEP team, written information regarding transportation as a related service should provide the necessary specificity so the driver, school, parent and student know what services to expect.

The IEP team can be reconvened at any time and by any team member who deems it necessary. Transportation services personnel should initiate such a meeting if, after implementing the program, they find they need more information or assistance from team members or if they find the program to be in any way unsafe.

## **GUIDELINES**

The following guidelines are intended to assist in establishing a training program for administrative and school-based personnel enabling them to respond to the concerns presented by students with disabilities, as required by IDEA. The goal of such a training program is to teach the skills needed to respond to routine and emergency circumstances concerning transportation.

### **A. School/Education Administration**

School administrators and education staff who help make program decisions for students with disabilities, including the requirement for transportation as a related service, are frequently unfamiliar with transportation capabilities and limits. Those persons should have training in areas that include the following:

1. Situations under which transportation staff would be consulted, or included in the IEP Team process.
2. State and local transportation policies and procedures, including communications and reporting procedures.
3. Transportation regulations which could assist in determining if transportation would be appropriate as a related service.
4. Alternative transportation options.
5. Current legislative, legal and administrative decisions.
6. The application of Least Restrictive Environment regulations to transportation placements.

7. The extent of training and skill levels available within the transportation staff and any additional training necessary to meet standards for qualified staff, as defined by local, state and federal standards.
8. The types of vehicles used for transporting students with disabilities.
9. The types of equipment and occupant securement systems used.
10. Do Not Resuscitate (DNR) policies for local school districts, as well as current legislative and administrative decisions concerning this topic.

B. Transportation Administration

With increased responsibility being imposed on transportation providers through actions taken by legislative, legal and administrative authorities, those in leadership roles must involve themselves to a greater degree.

The duties and responsibilities of transportation leadership likely will differ between various transportation providers; however, listed below are some areas of knowledge that are necessary to satisfactorily perform the leadership responsibilities:

1. Federal, state and local laws and regulations regarding the equipment required on vehicles used for transporting students with disabilities.
2. Federal, state and local laws and regulations regarding special education staff.
3. Operational regulations, such as student pick-up/drop-off, including criteria requiring curb-to-school or door-to-school.
4. Special education transportation regulations, such as student riding time and suspension period limitations.
5. Due-process rights and procedures of a student with disabilities.
6. Student referral, evaluation and IEP process.
7. A general knowledge of the identity of resource persons and the location and availability of appropriate training.
8. Vehicle staffing requirements, including when an attendant might be needed.

9. The availability of emergency medical services in the community and the identity of those who could assist if such an emergency were to occur during transportation.
10. State and local laws relating to child abuse and harassment reporting procedures.
11. State or local laws relating to limits of liability and policies and procedures for risk management.
12. Federal and state rules of confidentiality.
13. Legislative and administrative decisions and procedures concerning DNR.

C. Drivers and Attendants

As direct-service providers to students with disabilities, drivers and attendants have a hands-on responsibility to operate special equipment, manage student behavior and provide basic first aid as necessary. Additionally, they must be knowledgeable in passenger positioning, securing adaptive and assistive devices and be familiar with the nature, needs and characteristics of the types of students they transport.

1. Training components

To perform the responsibilities assigned in a safe and effective manner requires a substantial degree of specific training. Some training components that transportation staff must have are:

- a. Introduction to special education, including characteristics of disabling conditions, the student referral, assessment, IEP process, and confidentiality of student information.
- b. Legal issues, including federal and state laws, administrative rules, and local policy.
- c. Operational policies and procedures, including:
  - (1) Loading/unloading;
  - (2) Securing the bus;
  - (3) Pick-up/drop-off location;
  - (4) Evacuation procedures, including the use of emergency equipment, such as belt cutter(s), fire blankets, etc.;

- (5) Lifting/positioning procedures;
- (6) Student accountability and observation, including evidence of neglect or abuse;
- (7) Post-trip vehicle interior inspections for students or articles left in the bus prior to parking;
- (8) Reporting and record-keeping;
- (9) Lines of responsibility relative to role as an educational team member;
- (10) Lines of communication, including parents and educational staff;
- (11) Route management, including medical emergencies, no adult at home, inclement weather, field trips, etc.;
- (12) Behavior management;
  - (a) Techniques for behavior modification and the development of appropriate behavior;
  - (b) Procedures for dealing with inappropriate or unacceptable student behavior that creates emergency conditions, or poses a risk to health and safety;
  - (c) Procedures for documenting and reporting inappropriate or unacceptable student behavior; and
  - (d) Techniques and procedures for response to unacceptable behavior, including possession and transportation of weapons, drugs, etc. Awareness of gang activities, harassment/bullying and/or other inappropriate behaviors.
- (13) Blood borne pathogens and universal precaution procedures, including use of personal protective equipment; and
- (14) Policies and procedures that ensure confidentiality of personal identifying information.

D. Special Equipment Use and Operation:

A variety of equipment is required on vehicles used to transport students with special needs. It is necessary for transportation staff to be familiar with the design and operating procedures for this special equipment, as well as know how to conduct equipment inspection and make simple “field adjustments” during breakdowns. Some examples are:

1. Power lifts, including procedures for manual operation;
  - a. During lift operations (including manual) no one shall be allowed to stand on the lift platform. **Note:** Children using mobility aides/ devices other than a wheelchair or equivalent (resulting in other than a seated position) who need to use the lift, should use a wheelchair for boarding or exiting the bus, and then should be transferred to a bus seat for the ride.
  - b. For lift boarding purposes, wheelchairs or other wheel-based mobility devices should not be loaded unless they are equipped with a functional wheel locking system.
2. Emergency escape exits, including doors, windows and roof hatches;
3. Special fire suppression systems, including emergency fire blanket;
4. Power cut-off switches;
5. Emergency communications systems;
6. Climate-control;
7. Adaptive and assistive devices used to support and secure students, including mobile seating devices, child safety restraint systems, safety vests, wheelchair tiedown/occupant restraint systems, assistive technology devices, trays and securement hardware, including their storage and securement;
8. Two-way electronic voice communication THAT CAN BE USED AT ANY POINT IN THE VEHICLE’S ROUTE should be provided and installed by the body manufacturer, distributor, school district, operator or other party in all school buses equipped, as well as used, to transport passengers with disabilities and special health care needs; and
9. Service animals that can be transported to assist the student with disabilities. (District policies and procedures, as well as training, should be established prior to transport.)

## E. Selecting Securement Sites on Wheelchairs

Decision-making should be a TEAM effort, not an individual's responsibility. Information on transport-certified wheelchairs shall be made available. Always consult school staff or a qualified professional.

1. Wheelchairs should be transported in a forward-facing orientation.
2. Securement systems for wheelchairs should be used in accordance with the manufacturer's specifications and recommendations and should include a minimum of a lap/shoulder belt, 4-point tiedown and appropriate occupant securement. (Refer to SPECIALLY EQUIPPED SCHOOL BUS SPECIFICATIONS.) If so labeled, the manufacturer's designated securement point shall be used. (Refer to APPENDIX E for guidelines on WC19 from the Ride Safe information provided by ANSI/RESNA, University of Michigan Transportation Research Institute [UMTRI].)
3. Sites selected, frequently should be located just below the wheelchair's seat on non-detachable, structural frame members. In addition, the following beneficial criteria should be taken into account: 1. welded sites are preferred; and 2. Frame members held together with hardened bolts are also acceptable.
4. Rear tiedown straps should be anchored directly behind the securement points on the wheelchair, with the front straps angled slightly outward to increase stability.
5. The lap belt should be threaded through the space between the armrest and the seating frame to achieve proper placement low over the hip bones of the occupant. The lap belt should never be placed over the armrest. When optimally placed, the belt's webbing's bottom edge should be touching the occupant's thighs. When looking at the lap belt's path to the floor from the side of the chair, it should be angled between 45 and 75 degrees to the horizontal. When using an integrated system (in which the occupant restraint is attached to the rear tiedowns of the wheelchair securement system), the rear wheelchair securement site must be selected with this in mind. Whether using an integrated or parallel (occupant restraint belts are separate of tiedown belts) system, at no time should the occupant ever carry the load of the wheelchair or its tiedown system. The occupant must be secured separate of the wheelchair and its tiedowns.
6. A "height adjuster" may be required to achieve appropriate belt position.
7. On a tilt-in-space wheelchair, the four sites must be either on the base of the wheelchair or on the seat/frame portion of the chair. For example, it is not effective to have the front hooks on the base of the chair and the rear

hooks on the seat/frame portion of the chair since it would create a “teeter-totter” effect.

**Note:** In response to changing wheelchair manufacturer design and specification, verify manufacturer’s instructions and/or recommendations for maximum attachment strength.

8. Wheelchair securements must **not** be on the crossbar, since this may cause the wheelchair to collapse.
9. Some wheelchair manufacturers make an add-on bracket that can be used as an alternative tiedown site for some wheelchairs. However, homemade brackets are not acceptable. Securement and restraint systems installed to secure wheelchair/mobility aids and to restrain the occupants should be used all together and in accordance with the manufacturer’s recommendations.
10. Immediately after their use, all securement hardware not permanently affixed to vehicle floors and sidewalls (tracks, plates) should be detached and stored in a bag, box or other compartment.
11. Wheelchair tracks or plates should be swept, vacuumed or otherwise cleaned, as needed to keep the equipment functional.

F. Medical/Health Issues:

Regulations make it necessary to transport students who have severe medical/health conditions, and transportation staff may find it necessary to provide emergency health care to students during the transportation process. Additionally, transportation staff may be exposed to contagious and/or communicable diseases. Training regarding medical health issues can be divided reasonably into two categories; precautionary handling and care, intervention and management.

1. Precautionary handling

All transportation staff, including drivers, attendants, technicians and service personnel, such as washing and cleaning staff, should be trained in universal precautions relative to the handling and exposure to contagious and communicable disease, and informed about available immunizations. Suggested topics may include, but not limited to the following:

- a. Characteristics of contagious and communicable diseases;
- b. Disease management techniques; and



- c. Use of protective equipment and devices.

2. Care, intervention and management

Medically fragile, technology-dependent and/or highly disruptive students require specific care and intervention. Knowledge of basic first aid and cardiopulmonary resuscitation provides adequate training to care for most health concerns during transportation. For those students who need additional care, management or intervention, or who present specific health risks, a care plan shall be developed during the assessment/evaluation process by the IEP Team. This plan details the care and training needed, as well as the qualifications necessary of those who will carry out the plan, and specifies and provides the transportation department with the following information:

- a. A brief description of the student's current medical, health or behavioral status, as well as an emergency card with information which shall include address, emergency phone numbers, etc.;
- b. A description of the medical/health care or intervention necessary during transportation, including the frequency required;
- c. A description of who should provide the care or intervention;
- d. The type and extent of additional training or skills necessary for the driver and/or attendant. This may include the inspection, operation and use and care of the student's special adaptive/assistive equipment, including items, such as oxygen containment systems, suctioning equipment, apnea monitors, ventilation equipment, etc.;
- e. A description of emergency procedures to be implemented during a medical/health crisis, including communication with medical staff;
- f. A description of the procedures to be followed in changing the care plan when conditions indicate a change is warranted; and
- g. A written emergency evacuation plan that gives detailed, student-specific procedures.

**Note:** It is recommended that drivers and/or attendants only provide routine/customary, non-medical assistance, as needed. Those issues which require either ongoing care or diagnosis should be handled only by a trained medical professional.

## **CONFIDENTIALITY**

Information provided to transportation staff to assist in the orderly and safe transportation of a student, including disabling condition, medical/health issues, or other personal characteristics or information, is protected by the provisions of the Family Educational Rights and Privacy Act (FERPA), and transportation staff shall be trained regarding confidentiality requirements.

## **DEVELOPMENT**

In education, there are many laws, rules and regulations that dictate the service that must be provided, but few of them offer directions or suggestions as to how the service is to be provided. Transportation policies and procedures should be developed, adopted by the Board and periodically updated to reflect changes in federal, state and local regulations.

- A. Local policies and procedures should address the following:
1. Transporting medications;
  2. Student management and discipline;
  3. Physical intervention and management;
  4. Securing the vehicle, loading, and unloading;
  5. Safety vests, restraints and other positioning devices;
  6. A plan for students with disabilities during early closing of school due to inclement weather or other emergencies;
  7. Authority to operate special equipment (driver, attendant, parent, students, school staff or others);
  8. A plan to address occasions when no adult is home to receive a student who requires assistance and/or supervision; which may include an alternative, supervised drop-off location;
  9. A plan to remove from service those pieces of specially designed equipment that are damaged or present a safety hazard;
  10. A plan to address insufficient information in the student referral process;
  11. Student pick-up/drop-off location;
  12. Control and management of confidential information;

13. A plan for community emergency medical/law enforcement personnel involvement; and
14. District policy for Do Not Resuscitate (DNR) requests from parents, to include all appropriate school and transportation personnel. (Classroom and school bus policies may differ; however, drivers and attendants should adhere to transportation policies.)

B. Policy Approval

All policies shall be in writing, and formally approved by the appropriate education authority. Procedures shall include establishing time lines for periodic reviews or revisions.

### **EMERGENCY EVACUATION OF STUDENTS WITH DISABILITIES**

Each bus route should have a written emergency evacuation plan. This plan should include a student's ability to evacuate or help others. Students with disabilities should participate in required evacuation drills and should only be excluded if their participation would present a health risk. Every effort should be made to ensure ALL students have a reasonable understanding of the concept of an emergency. The driver/attendant must be familiar with any equipment in the bus that would aid in an actual evacuation, (e.g., the use of all emergency exits, emergency/fire blankets, belt cutters, etc.). It is important to enlist the help of school liaisons, parents and other personnel, such as physical therapists, to train and help students understand emergency procedures. Local emergency personnel should be involved in developing the plans, especially if the students transported have complex medical conditions.

### **EXTENDED SCHOOL YEAR**

Transportation as a related service may be required under Extended School Year provisions of IDEA:

- A. Extended School Year (§300.309) IDEA Definition:
  1. The term extended school year services means special education and related services that are provided to a child with a disability:
    - a. Beyond the normal school year of the public agency;
    - b. In accordance with the child's IEP; and
    - c. At no cost to the parents of the child and meet the standards of the State Education Agency (SEA).

2. Each public agency shall ensure that extended school year services are available, as necessary to provide Free Appropriate Public Education (FAPE).

B. OH Subpart C - 6

1. Extended school year services must be provided only if a child's IEP team determines, on an individual basis, in accordance with the IEP provisions, that the services are necessary for the provision of FAPE to the child.
2. In implementing these requirements, a public agency may not:
  - a. Limit extended school year services to particular categories of disabilities; or
  - b. Unilaterally limit the type, amount or duration of those services.

**INFANTS  
TODDLERS AND  
PRE-SCHOOL  
CHILDREN**



# INFANTS, TODDLERS AND PRE-SCHOOL CHILDREN

## INTRODUCTION

Infants, toddlers and pre-school children are the youngest, most vulnerable passengers on school buses. They depend on transportation personnel to provide a safe ride to and from early intervention, Head Start programs and Teen Parent Programs. Transportation is a critical component for children and their families, accessing services to support a child's growth and development. Transportation should be established as the mutual responsibility of parents, transportation and service providers.

Programs supported and funded by federal, state and local governments have made great strides in developing, designing and providing services for young children and their families to develop each child's full potential. The school bus, for many children, is the primary vehicle that provides access to programs and services designed to meet individual needs of young children and families.

Transportation providers need to be knowledgeable and to develop skills to provide for the safety of young children while being transported in school buses. Infants, toddlers and pre-school children, in addition to those young children with special physical, cognitive or behavioral needs, present new challenges and responsibilities for transportation providers. These children require a great deal of supervision during the time they are in and around the school bus. Some issues that must be addressed to assure safe transportation in the school bus include physical handling, communication with young children, behavior management, knowledge of child safety restraint systems (CSRSs), wheelchair tie-down and occupant restraint systems, special equipment management, medically fragile and complex conditions, confidentiality, length of ride, personnel training and parental responsibilities.

Children under the age of five who reside in rural, suburban and urban areas are daily passengers in school buses. Since the exact number of children under the age of five riding in school buses is unknown, uniform transportation data on this population should be collected. This population includes children served in several programs for children from birth through age five. These programs include the Early Intervention Programs for Infants and Toddlers With Disabilities (Part C, Individuals with Disabilities Education Act), the Pre-schools Grant Program, the Early Education Program for Children with Disabilities, Head Start, Bureau of Indian Affairs Programs and the Teen Parent Program. In addition, federal programs support a number of discretionary projects that are designed to promote services for young children with disabilities and their families.

Due to the numbers of young children under the age of five who are transported in school buses, it is essential to recommend guidelines for child safety seats, occupant child safety restraint systems and securement systems. The purpose of this section is to assist transportation personnel by recommending policies, procedures and guidelines, while simultaneously recognizing the need for continued research studies to meet the needs of young children from birth to age five who ride school buses nationwide. (Refer to the APPENDIX F for listings of laws and characteristics of disabilities.)

## **TRANSPORTATION SERVICES FOR INFANTS AND TODDLERS WITH DISABILITIES**

The Individualized Family Service Plan (IFSP), under Part C of the Individuals with Disabilities Education Act (IDEA), is the mechanism for addressing the unique needs of infants and toddlers with disabilities and their families. The IFSP process has two main parts: (1) the IFSP meeting, where parents and interagency personnel jointly make decisions about an eligible child's early intervention services; and (2) the IFSP document, itself, which is a written plan for the provision of early intervention services for the child and family.

The decision to provide the early intervention service of transportation is made on a case-by-case basis and is directly related to the need for this service. Given the significance of the IFSP process, there are numerous requirements concerning the IFSP document. The decision for a transportation representative to attend the IFSP meeting should be made on a case-by-case basis when a school bus is considered as the vehicle to transport an infant or toddler to and from a program location. This decision should be based on the individual needs of the child and family, as well as the service provider. The transportation representative should be a member of the IFSP team whenever the unique needs of an individual child require specialized service beyond the scope of what is traditionally provided. The involvement of transportation personnel should occur as soon as it is known that a child with a specialized need requires transportation on a school bus.

## **TRANSPORTATION SERVICES FOR PRE-SCHOOL CHILDREN WITH DISABILITIES**

Pre-school children who ride school buses include children with and without disabilities. All pre-school children require careful planning when a school bus is selected as the mode of transportation to and from a state or local government early intervention program, special education, Head Start or Early Head Start program. These programs may have significantly different requirements governing transportation, and the transportation requirements should be reviewed carefully.

If a child is eligible for special education and the related service transportation under Part B of IDEA, the mechanism for addressing transportation services is the Individualized Education Program (IEP). The IEP process has two main parts: (1) the IEP meeting(s), when parents and school personnel jointly make decisions about a child's special educational program; and (2) the IEP itself, which is a written record of the decisions agreed upon at the IEP meeting. The IEP document is a written commitment and management tool for the school district. The IEP defines resources and services to be provided to the student at no cost, and it states when and for how long these services will be provided. As such, the IEP becomes the tool to monitor compliance.

The "1997 IDEA Amendments" require that a public agency provide transportation to a pre-school age child as a related service to the site at which the public agency provides



special education and related services to the child, if that site is different from the site at which the child receives other pre-school or day care services.

One of the major differences between the IFSP services and IEP is that the early intervention program under Part C for infants and toddlers is a year-round program, whereas special education services under Part B represent a school-year program, unless otherwise specified by the IEP committee.

The decision for transportation personnel to attend IFSP and IEP meetings should be made on a case-by-case basis. This decision should be based on the individual needs of the child and family and the need for transportation personnel to provide this service safely. Transporting young children requires careful planning prior to initiating transportation services in school buses. Due to the ages of these children, the type of service required and frequency and duration of transportation must be determined on a case-by-case basis. Prior to initiation of service, the following questions and concerns should be addressed:

- A. Is the child medically stable to be transported? (This decision should be made by a physician or school nurse whenever the question arises.)
- B. What is the length of the ride? Does the length of ride place the child at risk based upon the child's age, developmental and functional level and environmental factors, such as weather and temperature in the bus? (This decision should be made by a physician or school nurse whenever the question arises.)
- C. Which physical, cognitive, communication, social-emotional and behavioral concerns should be addressed prior to initiating transportation services? (Each of these areas should be addressed by qualified personnel.)
- D. Which assistive or adaptive devices are necessary to accommodate the special needs of a child during the provision of transportation services? (This should be addressed by qualified personnel.)
- E. What type of supervision is necessary to assure safe transportation? What parental responsibilities are to be addressed on the IFSP or IEP documents? (These decisions should be made by the full IFSP or IEP Committee.)
- F. When a child is medically fragile and requires special handling, who is responsible for emergency procedures? Who is responsible for monitoring universal precautions in the school bus if it is known that a child has an infectious disease that requires special precautions? (This decision should be made by the full IFSP or IEP Committee.)
- G. If a child is provided with a private-duty nurse (non-IEP), how are the services addressed on an IEP? It is recommended that authorized transportation and special education and early intervention personnel committed to special services

converse prior to the IFSP or IEP team meeting. The mechanism for decision-making for all special services is the IFSP or IEP process for children receiving services under IDEA.

- H. What transportation equipment or equipment modification is required to accommodate the child's special needs and safety? (This decision should be made by the full IFSP or IEP Committee.)

## **HEAD START**

Head Start programs are required to provide special services for three through five-year-old children with disabilities. Head Start programs are required to have a "Disabilities Coordinator" who is responsible for developing a disabilities service plan that provides for the special needs of children with disabilities and their parents. This plan must specify those services to be provided directly by Head Start and those that are provided by other agencies. Transportation is one of the related services addressed under 1308.4(o)(5).

The Department of Health and Human Services, Administration on Children, Youth and Families (ACYF), Administration for Children and Families (ACF) issued 45 CFR 1310 Head Start Program; Final Rule on January 18, 2001 (Volume 66, Federal Register Number 12). This final rule implements the statutory provision for establishing requirements for the safety features and safe operation of vehicles used by Head Start agencies to transport children participating in Head Start programs. The reference to obtain this final rule is in APPENDIX F.

Additional information is available from The Department of Health and Human Services, Administration on Children, Youth and Families (ACYF), Administration for Children and Families (ACF) issued January 16, 2004 45 CFR 1310 Head Start Program [Federal Register: January 16, 2004 (Volume 69, Number 11)]. The reference to obtain this rule is in APPENDIX F.

Transportation is a related service to be provided to children with disabilities. When transportation to the program site and to special services can be accessed from other agencies, it should be used. When it is not available, program funds are to be used. Use of taxis is an allowable expense if there are no alternatives available and transportation is necessary to enable a child to be served.

## **GUIDELINES FOR INFANTS, TODDLERS AND PRE-SCHOOL CHILDREN**

The following guidelines are designed specifically to assist with transportation decision-making for infants, toddlers and pre-school children.

- A. Administrator's Role

The transportation supervisor (or designee) should be responsible for the supervision of transportation services for infants, toddlers and pre-school

children. It is essential that this individual be knowledgeable about the unique needs of this age group.

Transportation personnel responsible for the daily transportation of young children should receive appropriate training from professionals qualified to make decisions regarding child safety, seating, communication, physical handling, health and medical needs and other special circumstances. Based on a curriculum developed by The National Highway Traffic Safety Administration (NHTSA), National Safe Kids Coalition certifies child passenger safety technicians. The child passenger safety technician training is sponsored by a variety of organizations, including law enforcement, hospitals, public health, insurance companies, etc. Each school district should have policies and procedures in place regarding the transportation of children from birth to age five. The policies and procedures should specify when it is required that the transportation supervisor or a designee attends IFSP, IEP or Head Start meetings. Transportation of children with special needs should be addressed on the IFSP or IEP when this service is provided. The transportation supervisor should be responsible for the following:

1. Selecting vehicles used for infants, toddlers and pre-school children;
2. Training drivers and attendants who transport infants, toddlers and pre-school children;
3. Selecting equipment and CSRSs specific to the transportation of infants, toddlers, and pre-school children;
4. Disseminating information about “parents’ responsibilities” in their native language, whenever possible;
5. Providing information about appropriate practices when transporting young children with special needs, including confidentiality of information;
6. Establishing emergency policies and procedures, including practicing evacuation drills;
7. Establishing staffing requirements;
8. Assuring that transportation decisions for a child are made on a case-by-case basis and are appropriate to meet individual needs of a child in accordance with what is recorded on a child’s IFSP or IEP; and
9. Dissemination of pertinent student medical and behavioral information to support the school bus ride to and from school, including emergency information.

## B. Drivers

The driver must be knowledgeable about his responsibility for each child in the school bus. This includes safely operating the school bus and supervising the safety of all young passengers. These recommendations should be followed with or without the presence of a bus attendant. In addition to their regular duties, the drivers shall have knowledge and responsibility for the following:

1. General knowledge about the development of young children, including specific disability conditions;
2. Age-appropriate physical handling, communication and behavior management of young children;
3. Appropriate use of all the equipment (e.g., power lifts, child safety restraint systems, wheelchair tiedown and occupant restraint systems);
4. Loading and unloading of children who are ambulatory or non-ambulatory;
5. Evacuation and evacuation drills, including practicing evacuation drills;
6. Transportation requirements on a child's IFSP or IEP, including confidentiality;
7. Special needs in the vehicle [e.g., apnea, asthma or other respiratory conditions, life-threatening allergies and their potential triggers, assistive devices, communicable diseases, gastrostomy tubes, oxygen, technological dependence, shunts, tracheostomy tubes, medical devices, medically complex and fragile conditions, uncontrollable seizure disorders and "Do Not Resuscitate" (DNR) orders];
8. Child protection laws (e.g., abuse and neglect); and
9. Effective communication skills with school staff, students, parents, law enforcement officials and the motoring public.

## C. Bus Attendants (Monitors)

The bus attendant should assume primary responsibility for the supervision and safety of children in the school bus during its operation. Bus attendants should be knowledgeable and well-informed about infant, toddler and pre-school child development for both children with and without special needs. Attendants should be knowledgeable about the following:

1. The cognitive, communication, physical, social-emotional, behavioral development and functional level of young children, including the unique needs of specific children in relationship to their disabilities;
2. Using age-appropriate physical handling, communication and behavior management of young children;
3. Appropriate use of equipment in the school bus (e.g., power lifts; child safety restraint systems, such as child safety seats, safety vests and integrated seats; related securement systems, including vest mounting and safety belts; wheelchairs and wheelchair tiedowns and occupant restraint systems);
4. Loading and unloading of children who are ambulatory or non-ambulatory;
5. Evacuation and evacuation drills, including practicing evacuation drills;
6. Transportation requirements on the IFSP or IEP, including confidentiality;
7. Special needs in the vehicle [e.g., apnea, asthma or other respiratory conditions, life threatening allergies, and their potential triggers, assistive devices, communicable diseases, gastrostomy tubes, shunts, oxygen, technological dependence, tracheotomy tubes, medical devices, medically complex and fragile conditions, uncontrollable seizure disorders and “Do Not Resuscitate” (DNR) orders];
8. Child protection laws (e.g., abuse and neglect); and
9. Communicating effectively with school staff, students, parents, law enforcement officials and the motoring public.

#### D. Training

It is essential that all transportation personnel responsible for infants, toddlers and pre-school children receive training, which should include the following guidelines:

1. Training should be conducted by staff knowledgeable about the needs of young children who must be transported. Staff may include child passenger safety technicians, child development specialists, representatives of manufacturers of specialized equipment, nurses, occupational therapists, physical therapists, psychologists, respiratory therapists, special educators, transportation supervisors and other personnel, depending on the unique needs of the individuals being transported.

2. Training should take place both in a classroom and in the school bus.
3. There should be a checklist for the purpose of recording specific skills that have been mastered.
4. It is essential that all first aid training be specifically designed for the infants, toddlers and pre-school children.
5. All personnel transporting young children should be required to have a first aid course. Ongoing training should be conducted by certified personnel in their respective areas of expertise. The type of training provided should be directly related to the specific special services that the driver and attendant are required to provide, including developmental- appropriate practices. At a minimum, drivers and attendants should be able to operate any special equipment for which they are responsible, know how to manage infants, toddlers and pre-school children, be capable of implementing an IFSP- or IEP-approved health care service in accordance with state law and be trained about use and securement of adaptive and assistive devices.

Comprehensive training for transportation personnel providing daily services should include the following topics to support safe and appropriate transportation services for this young population and their families:

- a. Assistive-device management;
- b. Child Safety Restraint Systems (CSRSs);
- c. Communicable disease management practices;
- d. Communication (supervisors, school personnel, and parents);
- e. Confidentiality;
- f. Emergencies;
- g. Emergency evacuation drills, including practicing evacuation drills;
- h. Emergency information management requirements;
- i. Equipment;
- j. Evacuation;
- k. Federal and state regulations;

- l. First aid training;
- m. General characteristics of children with disabilities impacting the school bus ride;
- n. Individualized Education Programs (IEPs);
- o. Individualized Family Service Plans (IFSPs);
- p. Loading and unloading;
- q. Medically fragile children;
- r. Medicine transport;
- s. Pick-up and drop-off, including provisions addressing when an adult is not at the scheduled drop-off;
- t. Reports;
- u. Required record-keeping;
- v. Specialized communication;
- w. Special medical conditions;
- x. Technology-dependent conditions;
- y. The development of infants, toddlers and pre-school children with developmental delays and disabilities;
- z. Universal precautions;
- aa. Use of belt cutter; and
- bb. Vehicle selection.

#### E. Equipment

Great strides have been made in the type of equipment used to assist infants, toddlers and pre-school children with special needs. These children present multiple challenges to providers of transportation. The school bus vehicle is significant because it is the mechanism for transporting young children who have special needs to and from support and development programs. To assure child passenger safety in the school bus, transportation personnel will need training to work with infants, toddlers and pre-school children who use a variety of

equipment. Challenges relating to proper use and installation of Child Safety Restraint Systems (CSRSs), including car seats, arise. Many of these challenges are addressed in NHTSA's "Guideline for the Safe Transportation of Pre-school Age Children in School Buses." (February 1999.)

**Note:** Refer to "Proper Use of Child Safety Restraint Systems in School Buses" <http://www.nhtsa.dot.gov/people/injury/buses/busseatbelt/index.html>.

Infants, toddlers and pre-school children with special needs present a challenge for transportation personnel because school buses were not designed to transport young children as passengers.

Each pre-school age school bus passenger should use a child safety restraint system appropriate for the child's age, weight, height and specialized needs, as determined by the IEP or IFSP team.

**Note:** The following standards are applicable to this section.

FMVSS No. 208	Occupant Protection
FMVSS No. 209	Seat Belt Assemblies
FMVSS No. 210	Seat Belt Assembly Anchorages
FMVSS No. 213	Child Restraint Systems
FMVSS No. 217	Bus Emergency Exits and Window Retention Release
FMVSS No. 222	School Bus Passenger Seating and Crash Protection
FMVSS No. 225	Uniform Child Restraint Anchorages

All CSRSs used in the school bus must:

1. Meet requirements of FMVSS No. 213;
2. Be installed and used according to the manufacturer's instructions;
3. Not be under a recall which recommends non-use of the CSRS;
4. Have all parts intact and in working order;
5. Be secured to a vehicle seat with a safety belt that meets FMVSS No. 209 or anchorages to meet FMVSS No. 225 or FMVSS No. 210; and
6. Use safety belts or latch systems that are installed only on bus seats that meet FMVSS No. 210.

#### F. Child Safety Restraint Systems (CSRSs)

CSRSs used in school buses must be appropriate for the individual child and must be used correctly. All of the restraint systems used for transportation must be



secured to the bus seat in the manner prescribed and approved by both the school bus and CSRS manufacturer.

## 1. Elements of Correct Installation of CSRSs

It is recognized that compartmentalization, the passive safety system required in school buses under FMVSS No. 222, provides a higher level of safety to children over 40 pounds. Children diagnosed with medical complexities or fragility might require special securement or positioning systems.

### a. Direction

Position (rear-or forward-facing) and adjust recline angle accordingly. Some rear-facing seats are designed for rear-facing only and may not be used in a forward-facing position. (Check manufacturer's instructions.)

### b. Belt Paths and Harness Strap Location

Use the correct belt path and harness strap slots on the CSRS as directed by the manufacturer's instructions.

**(Note:** Heavy coats may be removed to ensure a tighter fit.)

### c. Installation

To achieve tight installation, the adult's full weight should be placed into the seat of the CSRS to compress the vehicle seat cushion. With the buckle(s) engaged, pull the loose end of the seat belt(s) to tighten and lock the safety belt. The CSRS should not move more than one inch forward or side-to-side when tested by grasping the seat at the belt path.

## 2. Types of Restraints

### a. Rear-facing CSRS (infant-only)

(1) These seats are designed for infants from birth to twenty or twenty-two pounds (manufacturer's instructions) and who usually are less than 26 inches in length. These seats are used in rear-facing position at a 45 degree recline which provides support to the infant's head, neck and back.

(2) Harness straps must be at or below the infant's shoulders and must be snug. A snug strap should not allow any slack,

should lie in a relatively straight line without sagging and should not press on the child's flesh or push the child's body into an unnatural position. When properly fitted, harness strap material should not be able to be pinched between thumb and forefinger. The harness retainer clip, which is designed to hold the harness straps in place, should always be placed at armpit level.

- (3) Avoid any extra padding or blankets behind or beneath the infant.

b. Convertible CSRS (Rear-Facing)

- (1) Rear-facing infant position is designed for children from birth to twenty pounds, one year of age (manufacturer's instructions), weighing up to twenty pounds and usually less than 26 inches in length. Many CSRSs are now available to accommodate larger children (30 to 35 lbs.) in the rear-facing position.

**Note:** See manufacturer's guidelines for weight and height restrictions. It is recommended that children ride rear-facing as long as recommended or allowed by the CSRS manufacturer.

- (2) The rear-facing position at a 45 degree recline supports the infant's head, neck and back.
- (3) The harness straps must be at or below the infant's shoulders.
  - (a) Harness straps must be snug. A snug strap should not allow any slack, should lie in a relatively straight line without sagging and should not press on the child's flesh or push the child's body into an unnatural position. When properly fitted, harness strap material should not be able to be pinched between thumb and forefinger.
  - (b) The harness retainer clip, which is designed to hold the harness straps in place, is always at armpit level.
- (4) Do not use any extra padding or blankets behind or beneath the infant.

- (5) Avoid the use of a T-shield or tray shield with infants or young children with eyeglasses, feeding tubes, shunts or other medical devices that may come in contact with the shield. Avoid use of CSRSs with a shield with children who, due to their stature, may not fit into the seat snugly or may make contact with the shield with their face or neck.

c. Convertible CSRS (Forward-Facing)

- (1) Forward-facing CSRSs with five-point harness, T-Shield or tray-shield are designed for children above twenty to sixty pounds. (Rear-facing position should be maintained for as long as recommended or advised by the manufacturer.) Some forward-facing-only seats are available to accommodate larger children.
- (2) All forward-facing seats should be adjusted to the upright position.
- (3) Harness straps must be in the upper slot (at or above the child's shoulders). (Check manufacturer's guidelines.)
- (4) The seat may be used until the child's ears are above the back of the shell.
- (5) Harness straps must be snug. A snug strap should not allow any slack, should lie in a relatively straight line without sagging and should not press on the child's flesh or push the child's body into an unnatural position. When properly fitted, harness strap material should not be able to be pinched between thumb and forefinger.
- (6) Avoid the use of a T-shield or tray shield with infants or young children with eyeglasses, feeding tubes, shunts or other medical devices that may come in contact with the shield. Avoid use of CSRSs with a shield with children who may not fit into the seat snugly due to their stature.

**Note:** There are some CSRSs that cannot be installed properly in a twenty-inch bus seat (i.e. tray-shield and some convertible seats).

d. Car Beds

**Note:** A car bed for infants up to 20 pounds allows the infant to lie flat. The use of a car bed should be predicated on the advice of a physician or an appropriate medical support professional (e.g.

physical/occupational therapist) and approved by qualified personnel at an IFSP team meeting.

- (1) Lateral support can be added with rolled up towels or receiving blankets at both sides of the infant. Do not place around the infant's head padding that would cause an airway blockage.
- (2) Beds must be secured to the bus seat, with the seat belt passing through both slide loops. Check and use manufacturer's instructions before using beds.
- (3) Adjust the harness system to a snug fit as specified by the manufacturer. Harness straps should lie flat (not twisted).
- (4) Caution should be given to gastrostomy tubes, trachostomies and shunts.

e. Specialized Positioning Seats

- (1) These seats are used only when a child does not fit in a standard CSRS or has a particular condition warranting more support.
- (2) As per the NHTSA'S, "*CHILD PASSENGER SAFETY TRAINING INSTRUCTOR GUIDE FOR SCHOOL BUSES*," tether straps are not required in school buses, however, some special needs CSRSs require a tether strap. (See manufacturer's instructions and all NHTSA curriculums to determine the specifics.)

When a tether strap is used, the seat to which it is tethered must be unoccupied. For further clarification on the proper use of tethers, consult with a CPS (Child Passenger Safety) technician.

- (3) The safety belt must be routed through the appropriate belt path specified by the manufacturer's instructions to secure the CSRS.
- (4) If a retainer clip is used, it must be positioned at armpit level.
- (5) Caution should be given to gastrostomy tubes, trachostomies and shunts.

f. Booster Safety Seats (Belt Positioning Boosters Only)

A booster seat should be used only if children are between 40 and 80 pounds, depending on the manufacturer's instructions, and must be used in conjunction with a lap-shoulder belt; therefore, they are not to be used on a traditional bus seat.

g. Safety Vests

**Note:** This restraint must be used only on school bus seats. The entire seat directly behind the child in the seat-mounted vest must be unoccupied or have restrained occupants.

- (1) Vest selection should be appropriate for the size and needs of the child. Proper fit must account for seasonal changes in clothing.
- (2) The decision to use a vest should be made by an IFSP or IEP team that includes qualified personnel and the parent.
- (3) The use of safety vests should be noted on the IFSP or IEP.
- (4) Vests should be anchored, as specified by the manufacturer.
- (5) The decision to use vests for wheelchair usage must be made by an IFSP or IEP team that includes qualified personnel and the parent and should be noted on the IFSP or IEP.
- (6) Caution should be given to gastrostomy tubes, tracheostomies and shunts.
- (7) Pre-school children, due to their age, weight, physical development and their overall mental ability, should be securely fitted with a crotch strap supplied by the manufacturer. (All vests are required under FMVSS 213 to have a crotch strap. It is not optional.)
- (8) If unrestrained students share the seat with a student in a child safety restraint, the student using the restraint should be placed in a window seating position, but never in front of an emergency window.
- (9) The seat behind the child in a vest must be kept empty or occupied by a child who is also in a child safety restraint system.

- (10) Portable seat mounting straps should be checked for proper fit by transportation personnel during pre-trip inspections.

h. Wheelchairs

- (1) All decisions regarding the use of wheelchairs in the school bus must be made by an IFSP or IEP team that includes qualified personnel and the parent and should be noted on the IFSP or IEP.
- (2) Appropriate positioning of a child in a wheelchair should be made by qualified personnel, including IFSP or IEP committee members, and should be noted on the IFSP or IEP.
- (3) The IFSP or IEP team, including qualified personnel, should determine when it is appropriate to transfer a child from a wheelchair and place the child in an age-appropriate CSRS on the original manufacturer's seat.

G. Bus Seat Designated for a Child Safety Restraint System

The transportation provider should ensure installation and use in accordance with the following NHTSA guidelines:

1. Locations of school bus seats designated for CSRSs should start at the front of the vehicle to provide drivers with quick access to the CSRS occupants.
2. CSRS anchorages on school bus seats should meet all applicable FMVSSs.
3. The non-adjustable end of the lap belt should be positioned at the center for a CSRS placed next to the window; or, at the aisle for a CSRS placed next to the aisle.
4. The non-adjustable end of the lap belt must not extend more than one to two inches from the seat.
5. When ordering new school buses, the maximum spacing specified under FMVSS No. 222, School Bus Passenger Seating and Crash Protection, (within 24 inches space from the seating reference point) is recommended for seats designated for CSRSs to provide adequate space for the CSRSs.
6. The combined width of CSRSs and/or other passengers on a single seat does not exceed the width of the seat.

7. If other students share seat positions with CSRSs, the CSRSs are placed in the window-seating position, excluding emergency exit windows.

#### H. Medical Equipment

All decisions regarding medical equipment in the school bus should be made in accordance with state laws and regulations. Decisions regarding medical equipment should be the joint decision of trained personnel who are knowledgeable about the type of medical assistance and support an infant, toddler or pre-school child may need while in a school bus. Decisions should be made by qualified team members in attendance at IFSP or IEP meetings, including the parent. The IFSP or IEP document should include all the appropriate information. Safe transportation specifications should be documented on the IFSP or IEP. Some special considerations and recommendations are as follows:

1. All medical support equipment shall be secured at the mounting location to withstand a pulling force of five times the weight of the item.
2. Latched compartments are the preferred methods of transport.
3. All medical equipment should be secured below the window.
4. Oxygen equipment (liquid or gas) should be approved by the manufacturer for transport, and should be securely mounted and fastened to prevent damage and exposure to intense heat levels.

**Note:** Refer to Section, SPECIALLY EQUIPPED SCHOOL BUS SPECIFICATIONS.

#### I. Special Considerations

Because of the dependency of young children and the need to make decisions on a case-by-case basis, the following section on special considerations is provided for guidance on a variety of issues related to the transportation of infants, toddlers and pre-school children.

##### 1. Confidentiality

Confidentiality of information should be assured in accordance with the requirements of the Individuals with Disabilities Education Act Amendment of 1997 (Part B and Part C), Head Start Regulations and the Family Education Rights and Privacy Act Amendments of 1996. All transportation personnel should receive annual training regarding confidentiality requirements.

2. Emergency information

All parents, guardians or persons in loco parentis should be requested to fill out emergency transportation cards prior to initiating services. At a minimum, each emergency information card should request the following information: child's name, date of birth, program attending, height, weight, parents' names, address, (two) emergency contacts, child's doctor, hospital preferences, allergies, current medications, medical, communication and behavioral concerns, bus equipment required and special conditions. This information should be reviewed semiannually and updated, at minimum, annually based upon the growth of infants and toddlers. The bus driver and attendant shall have access to this information in the school bus to safely transport students in CSRSs. A photo is recommended in accordance with the school district's policy. (This is especially helpful to substitute personnel.)

3. Equipment Maintenance

Procedures should be established for scheduled maintenance, cleaning and inspection of all equipment, including CSRSs. Procedures should be in place to assure that all equipment is checked regularly for recalls and for product expiration dates. Procedures must be in place for cleaning a CSRSs according to manufacturers' instructions. Proper disposal of outdated equipment is important.

**Note:** A recall list may be found at [www.nhtsa.dot.gov](http://www.nhtsa.dot.gov).

4. Evacuation

A written evacuation plan shall be prepared for all school buses transporting infants, toddlers and pre-school children. Evacuation drills shall be practiced on a scheduled basis, in accordance with approved written policies and procedures. Children attending Head Start are required to participate in at least three evacuation drills annually, including one in the bus in which the child will be riding. All buses shall be equipped with child-safe seat belt cutters to assist in the emergency evacuation of children in child safety restraint systems and wheelchairs.

Written evacuation plans should consider the following questions:

- a. What are the child's physical and mental abilities?
- b. Can the child exit the bus independently?
- c. Which children can be removed from the bus without their CSRS or specialized equipment?



- d. Which children cannot be removed from the bus without their CSRS or specialized equipment?
- e. How can children be kept safe when removed from the bus?

**Note:** If possible, depending on the width of the bus aisle, children in car seats should be evacuated from the bus in their car seats in order to maintain a controlled and safe environment once off the bus.

5. Accessory Adaptive Equipment

All lap boards or trays, augmentative communication devices and ambulation equipment that attach to wheelchairs should be removed and secured during the time the child is transported in the school bus. The IEP team should address case-by-case where this is not advisable.

6. Medically Complex and Fragile Children

Decisions regarding the safe transportation of medically complex and fragile children should be made by qualified personnel and addressed on the child's IFSP or IEP prior to initiating transportation services. All school buses transporting medically complex and fragile children should be staffed by personnel who are knowledgeable about an individual child's specific medical needs and should be trained to administer first aid to young children. IEPs for medically fragile children should contain a healthcare plan written by the school nurse based on doctor's orders and/or standard medical practices for applicable health issues.

7. Transporting Medications

A written policy and procedure should address transporting medication between home and school. In no instance should a child be allowed to transport medicine to and from the school on his person.

8. Radios/Two Way Communication and Cell Phones

All school buses transporting infants, toddlers and pre-school children should have two-way communications systems and designated contact persons during the time the children are transported in the school bus. Cell phones may be utilized as a communication means, when approved by the program.

9. Supervision

All infants, toddlers and pre-school children should be supervised in the school bus using the appropriate child-staff ratios based upon individually

determined needs and state licensing requirements, if transportation to school and/or child care center is involved. Additional supervisory personnel required to transport individual students should be determined on a case-by-case basis by qualified personnel. This information should be recorded on the IFSP or IEP document. If Head Start children must cross the street before boarding or after leaving the vehicle because curbside drop-off or pick-up is not feasible, they must be escorted across the street by the bus attendant or another adult. All children in these categories must be met by a responsible person, preferably an adult. Plans for alternative delivery, such as to Children's Protective Services, should be proceduralized, and a notice of disposition should be placed on the door. Unmet students should be returned to the school or other preplanned location, and school officials can attempt to contact parents for resolution.

10. Seating Plans

All school buses transporting infants, toddlers and pre-school children should have a seating chart that is kept in the school bus. This is necessary in the event there is an emergency or there is a substitute driver or attendant. Decisions regarding seating should be made on an individual child basis using information known about the child's special needs and occupant protection requirements.

**Note:** The placement and use of CSRSs should be according to the NHTSA, "*Guideline for the Safe Transportation of Pre-School Age Children in School Buses.*" (February 1999.)

11. Technology-Dependent Children

Decisions regarding the safe transportation of technology-dependent children should be made by qualified personnel and addressed on the child's IFSP or IEP. In all school buses transporting children who are technology-dependent, there should be qualified personnel who are knowledgeable about an individual child's specific medical needs and are trained to administer first aid or to carry out procedures specified on the child's IFSP or IEP. All medical service provisions should be in accordance with federal and state laws.

12. Universal Precautions

All transportation personnel involved in direct-service delivery for infants, toddlers and pre-school children should be directly trained in universal precautions related to the physical, day-to-day handling of young children and potential exposure to communicable and contagious diseases.

### 13. Post-Trip and Post-Run Segment Checks

Drivers are responsible to conduct a walk-through inspection of the school bus following drop-offs at each school and after the last delivery on each run segment. Prior to departing the bus for any length of time, a walk-through inspection must be conducted. The purpose of the walk-through inspection is to check on and under the seats for sleeping or hiding students and to identify any items which may have been dropped or left aboard the bus. Warning flag systems and/or electronic means may be used. Written policies and procedures should be in place for post-trip and post-run segment checks.



# **SCHOOL BUS INSPECTION**



# **SCHOOL BUS INSPECTION**

## **HISTORY**

School bus safety vehicle inspection programs vary greatly from state to state. Some states have no regulatory inspection program. In others, third-party inspections performed by regulatory agencies range from a biennial detailed, complete inspection by a single inspector or team to annual spot inspections of a limited number of components.

The personnel who conduct inspections have varying degrees of qualifications and experience, which range from technicians and police officers to administrative safety officials.

## **STATE INSPECTION PROGRAMS**

Each responsible party is urged to establish a neutral third-party inspection program. Some states have a system of self-inspection by individual school districts or contractors. While such programs can be effective, with no governmental oversight the effectiveness of the program will likely be scrutinized more thoroughly than programs where governmental oversight exists. Personnel conducting school bus safety inspections must be knowledgeable in the mechanical components of a school bus and be aware of all the applicable construction standards, laws, rules and all other requirements of their jurisdiction. States also should develop specific inspection regulations, rules, procedures and out-of-service criteria for all vehicles utilized in student transportation.

## **INSPECTION PROCEDURE**

School bus safety inspection should consist of a standardized inspection where vehicles are placed out of service based on standardized criteria. Such criteria should not, under any circumstances, exceed the manufacturer's recommendations for component condition, wear level or other tolerance for a particular vehicle. The procedure for individual bus inspections will vary, depending on the number of components to be checked, in accordance with local rules, regulations, number of buses to be inspected, number of inspection personnel available and the types of inspection facilities available (whether equipped with a pit or lift or if inspections are performed on a "creeper").

## **THE CRITERIA**

The purpose of these criteria is to identify critical school bus components and provide rationale that inspectors can utilize to determine if a school bus is safe for student transportation. While it is recognized that each state may have its own list of components to be checked and tolerances for each, these criteria are intended to establish nationwide minimums for inspecting and placing school buses out of service

The inspection items are numerically coded so that a database of the findings can easily be developed. The checklist includes the inspection item and a brief but concise description of the component or condition. If any listed component meets or exceeds the failure criteria specified for that component, then the school bus should not be allowed to transport students until the component is repaired.

It is intended that these criteria will provide a working document for both the Inspector and the Operator's maintenance program, but they are not intended to replace, modify or alter the vehicle manufacturer's recommended specifications.

Inspection methods for the inspection items listed in the "School Bus Recommended Out-of-Service Criteria" are presented in Attachment 3.

**School Bus Recommended Out-of-Service Criteria**  
**SCHOOL BUS BODY/CHASSIS**

ITEM NO.	INSPECTION ITEM	DEFECT	ACTION
10.00	<b>BRAKE SYSTEM</b>		
10.01	ADJUSTMENT	a) Any one brake beyond the adjustment limit (see attachment #1)	
10.02	AIR SYSTEM	<p>Fails to maintain pressure when:</p> <p>a) the leakage rate (brakes released) exceeds 2psi/min.</p> <p>b) the leakage rate (brakes applied) exceeds 3psi/min.</p> <p>c) fails to recover air pressure as recommended.</p>	
10.10	<b>BRAKE SYSTEM (hydraulic)</b>		
10.11	MASTER CYLINDER	<p>a) reservoir is below minimum level.</p> <p>b) any leak of fluid in the master cylinder unit or system.</p>	
10.12	PEDAL RESERVE	Fails to maintain manufacturer designed height and travel requirements. (OEM)	
10.13	POWER ASSIST UNIT	Fails to function as designed (OEM)	
10.20	<b>BRAKE COMPONENTS (AIR and HYDRAULIC)</b>		
10.21	BRAKE HOSES/TUBING	<p>a) Brake hose with any damage extending through the outer reinforcement ply.</p> <p>b) Any bulge or swelling when brakes are applied.</p> <p>c) Any restriction due to cracked, broken or crimped line/hose.</p> <p>d) Any line, tubing, hose or connection that is not constructed to meet all applicable manufacturing codes and standards. (OEM)</p>	
10.22	BRAKE SHOE/PAD LINING	<p>a) Any lining/pad worn to the recommended replacement measurement or wear mark.</p> <p>b) Lining pad is broken, not firmly attached to shoe or plate, or is contaminated with oil or grease.</p> <p>c) Fails to make contact with drum (frozen, binding, uneven).</p>	
10.23	BRAKE DRUM/ROTOR	Any drum or rotor that is cracked, improperly mounted, or worn beyond manufacturer's discard specifications. <b>Note:</b> Do not confuse short hairline heat check cracks with flexural cracks.	
10.30	<b>PARKING BRAKE</b>	Not present or working as designed.	
10.40	<b>STEERING SYSTEM</b>	Any modification or other condition that interferes with the free movement of any steering component.	



ITEM NO.	INSPECTION ITEM	DEFECT	ACTION
10.41	STEERING COLUMN/ WHEEL	a) Any absence or looseness of U - bolt(s) or positioning part(s). b) Any worn, missing or damaged fastener. c) Steering wheel not properly secured. d) Steering wheel free play fails to meet the performance test. (see attachment #2)	
10.42	FRONT AXLE BEAM	Any crack(s) or obvious welded repair.	
10.43	STEERING GEAR BOX	a) Any mounting bolt(s) loose or missing. b) Any crack(s) in gearbox or mounting brackets. c) Any obvious welded repair.	
10.44	PITMAN ARM	a) Any looseness of the pitman arm on the steering gear output shaft. b) Any obvious welded repair.	
10.45	POWER STEERING	a) Auxiliary power assist cylinder loose. b) Power steering pump inoperable.	
10.46	BALL/SOCKET JOINTS	a) Any movement under steering load of a nut stud. b) Any motion, other than rotational, between any linkage member and its attachment point of more than 1/8 inch measured with hand pressure only. c) Any obvious welded repair.	
10.47	TIE RODS/DRAG LINKS	a) Loose clamp(s) or clamp bolt(s) on tie rod or drag links. b) Any looseness in any threaded joint.	
10.48	NUTS	Loose or missing fasteners on tie rod, pitman arm, drag link, steering arm or tie rod arm.	
10.49	HOSES/FLUIDS	Any faulty fluid control device, leak or empty reservoir.	
10.50	<b>SUSPENSION COMPONENTS</b>		
10.51	AXLE PARTS/MEMBERS	a) Any U-bolt or other spring to axle clamp bolt(s) which are cracked, broken, loose or missing. b) Any spring hanger(s), or other axle positioning parts which are cracked, broken, loose or missing that results in shifting of an axle from its normal position. c) Any worn (beyond manufacturer's specifications) or improperly assembled U bolt, shock, king pin, ball joint, strut, air bag or positioning component(OEM). d) Any spring hanger, assembly part or leaf which is broken or missing. e) Any broken coil spring.	

ITEM NO.	INSPECTION ITEM	DEFECT	ACTION
10.60	<b>CHASSIS/FRAME/ UNIBODY</b>		
10.61	FRAME	a) Any cracked, loose, sagging or broken frame side rail.	
		b) Any obvious bend or damage resulting from a collision.	
		c) Any worn or loose mounting hole.	
10.62	CROSS MEMBERS	Any cross member, outrigger or other structural support which is cracked, missing, deformed or has rust holes.	
10.63	OUTRIGGERS/BODY SUOPRT	Any missing, broken, shifted or corroded part that would affect the safe operation of the vehicle.	
10.64	BUMPERS	Any bumper which is missing or not secured.	
10.70	<b>EXHAUST SYSTEM</b>		
10.71	LEAKS	Any part of the exhaust system which is leaking or discharging under the passenger or engine compartment.	
10.80	<b>FUEL SYSTEM</b>		
10.81	FUEL CONTAINER/ CONNECTION	a) Any fuel tank not securely attached to the vehicle.	
		b) Any part of the fuel system not properly secured or fastened.	
		c) Any liquid fuel leak at any point.	
10.90	<b>DRIVESHAFT</b>		
10.91	DRIVE SHAFT GUARD	Loose, missing, improper placement or bent guards.	
10.92	UNIVERSAL JOINT(S)	Worn or faulty, or obviously repair-welded universal joint(s).	
11.00	<b>DIFFERENTIAL</b>		
11.01	HOUSING	Cracked or leaking housing.	
11.10	<b>ENGINE</b>		
11.11	COMPONENTS	Any Critical component that fails to function as designed.	
11.12	LEAKS	Any fluid leaks that would affect the safe operation of the engine.	
11.20	<b>TIRES/WHEELS/HUBS</b>		
11.21	TIRE TREAD DEPTH	Any front tire worn to less than 4/32 inch or any rear tire worn to less than 2/32 inch.	
11.22	TIRE SIDEWALL	a) Any sidewall that is cut, worn or damaged to the extent that the ply cord is exposed.	
		b) Any observable bump, bulge or knot related to sidewall or tread separation.	
11.23	TIRE INFLATION	Tire is flat or has noticeable leak.	
11.24	TIRE TYPE	Not of proper type (load range, size, mismatched, etc.)	
11.25	WHEELS/RIMS/SPIDERS	a) Any nuts, bolts, studs or lugs that are broken, missing, damaged or loose.	
		b) Any wheel/rim that is cracked, improperly seated, damaged, or welded.	

ITEM NO.	INSPECTION ITEM	DEFECT	ACTION
11.26	HUB	Excessive wheel bearing or king pin play that exceeds 1/4 inch.	
11.30	<b>aisle</b>		
11.31	CLEARANCE	Aisle does not have the required clearance.	
11.32	OBSTRUCTION	There are objects blocking aisles or exits.	
11.40	<b>ELECTRICAL</b>		
11.41	WIRING	Any required wire or electrical component that is charred or showing evidence of being burnt or exposed.	
11.50	<b>BATTERY</b>		
11.51	CONDITION	a) Battery will not activate the starter.	
		b) Leaking or excess corrosion.	
11.52	WIRES	Wiring is exposed or loose.	
11.53	BATTERY SECUREMENT	Battery not secured.	
11.60	<b>WINDSHIELD WIPERS</b>		
11.61	OPERATION	Wiper fails to work or is missing. Wiper does not clean windshield sweep area.	
11.70	<b>BODY INTERIOR</b>		
11.71	PANELS	Any panel (ceiling, side, wheel well, etc.) protruding, having sharp edges or not secured, that may cause injuries.	
11.72	FLOORS	Floor pan or inner panels that have excessive perforated areas or openings sufficient to cause a hazard to an occupant.	
11.73	STEP WELL	Any part of the step well or support structure that is damaged.	
11.74	STEP TREAD	Any condition that would present a tripping hazard.	
11.75	HANDRAIL	a) Missing or loose.	
		b) Fails the nut/drawstring test or has not complied with safety recall. (See NHTSA website. <a href="http://WWW.NHTSA.GOV">WWW.NHTSA.GOV</a> ;) )	
11.76	SEATS/BARRIERS	a) Any seat/barrier that is not secured properly.	
		b) Any seat/barrier material so defective that it compromises the integrity of occupant protection and compartmentalization.	
		c) Seat spacing fails to comply with FMVSS 222	
11.77	SEAT (Driver)	a) Fails to adjust or hold proper adjustment.	
		b) Any part of the driver's safety restraint assembly is missing, not properly installed or so defective as to prevent proper securement.	
11.78	DOOR (Entrance)	a) The entrance door does not open or close properly.	
		b) Door control handle does not lock in the closed position.	
		c) Door is equipped with a padlock or similar non-OEM locking device. (Excludes vehicles equipped with an interlock system)	

ITEM NO.	INSPECTION ITEM	DEFECT	ACTION
11.79	DOORS (Emergency exits)	a) Any emergency door(s) that does not open freely or completely as designed. b) Any emergency door warning device that is defective. c) Door or roof hatch is equipped with a padlock or similar non-OEM locking device. (Excludes vehicles equipped with an interlock system) d) Door hold open device is missing or inoperative.	
11.80	<b>WINDOWS</b>	a) Any glass or glazing that is broken through or missing. b) Not of approved type. c) Windshield has discoloration or other damage in that portion extending upward from the height of the topmost portion of the steering wheel, but not including a 2 inch border at the top and a 1 inch border at each side of the windshield or each panel thereof, except as follows are allowed: (1) Coloring or tinting applied in manufacture, for reduction of glare; (2) Any crack not over 1/4 inch long, if not intersected by any other crack; (3) Any damage area, which can be covered by a disc 3/4 inch in diameter, if not closer than 3 inches to any other such damaged area. d) Drivers side area window(s) have chips, clouding, or cracks that obscure the driver's vision.	
11.81	WINDOWS (Emergency Exits)	a) Any Emergency window that fails to open properly. b) Lacks the required number of emergency windows/roof hatches. (Fails to comply with FMVSS No. 217) c) Required audible warning device(s) not working properly. d) Not properly labeled inside or outside (fails to comply with FMVSS No. 217).	
11.82	DEFROSTERS	Fails to operate.	
11.90	<b>BODY EXTERIOR</b>		
11.91	PANELS, RUB RAILS, TRIM	Any body part that is loose, torn, dislocated or protruding from the surface of the bus, creating a hazard.	
11.92	COMPARTMENT DOORS	Any engine, battery or other door taht is not secured properly.	
11.93	MIRRORS	Any required mirror taht is missing, broken, discolored or will not hold a set adjustment.	
12.00	<b>LAMPS/SIGNALS</b>		
12.01	LAMPS	Any one of the following lamps not working: Brake, turn signal, tail, head (low beam), school bus warning lamps (amber or red), emergency, or stop arm lamp.	
12.02	HORN	Fails to function as designed.	
12.03	GAUGES/BRAKE WARNING	Any critical brake, telltale lamp, buzzer or gauge that fails to function as designed.	
12.04	STOP ARM/OPTIONAL CROSSING DEVICE	Required stop arm(s), or if equipped with a crossing control device fails to function properly.	
12.10	<b>EMERGENCY EQUIPMENT</b>		

ITEM NO.	INSPECTION ITEM	DEFECT	ACTION
12.11	FIRE EXTINGUISHER	Any required fire extinguisher(s) which is missing, not of proper type/size, not fully charged, has no pressure gauge, is not secured or is not accessible to the driver or that does not have an up-to-date inspection tag affixed to it.	
12.12	OTHER STATE REQUIRED EQUIPMENT	Any state required equipment (such as first aid kit and body fluid kit, belt cutter and emergency reflectors) that if not functioning correctly the state specifies is an out-of-service item.	
12.20	<b>WHEELCHAIR EQUIPPED VEHICLES</b>		
		a) Wheelchair lift does not function as designed or is inoperable. b) Any hydraulic line leaking during lift operation. c) Wheelchair tiedown is missing or improperly installed loose or damaged. d) Any required wheelchair occupant restraint system not in compliance.	

# ATTACHMENT 1 - BRAKE ADJUSTMENT SPECIFICATIONS

Brake adjustment: Shall be less than those specifications contained herein relating to “Brake Adjustment Limit.” (Dimensions are in inches.)

<b><u>CLAMP TYPE BRAKE CHAMBER DATA</u></b>		
<b><u>TYPE</u></b>	<b><u>OUTSIDE DIAMETER</u></b>	<b><u>BRAKE ADJUSTMENT LIMIT</u></b>
6	4 1/2	1 1/4
9	5 1/4	1 3/8
12	5 11/16	1 3/8
16	6 3/8	1 3/4
20	6 25/32	1 3/4
24	7 7/32	1 3/4
30	8 3/32	2
36	9	2 1/4

<b><u>'LONG STROKE' CLAMP TYPE BRAKE CHAMBER DATA</u></b>		
<b><u>TYPE</u></b>	<b><u>OUTSIDE DIAMETER</u></b>	<b><u>BRAKE ADJUSTMENT LIMIT</u></b>
<b>16</b>	<b>6 3/8</b>	<b>2.0</b>
<b>20</b>	<b>6 25/32</b>	<b>2.0</b>
<b>24</b>	<b>7 7/32</b>	<b>2.0</b>
<b>24*</b>	<b>7 7/32</b>	<b>2.5</b>
<b>30</b>	<b>8 3/32</b>	<b>2.5</b>
<b>* For 3" maximum stroke type 24 chambers</b>		

<b><u>TIE ROD STYLE PISTON BRAKE CHAMBER DATA</u></b>		
<b><u>SIZE</u></b>	<b><u>OUTSIDE DIAMETER</u></b>	<b><u>BRAKE ADJUSTMENT LIMIT</u></b>
30	6 1/2 (165mm)	2.5 (64mm)

<b><u>BOLT TYPE BRAKE CHAMBER DATA</u></b>		
<b><u>TYPE</u></b>	<b><u>OUTSIDE DIAMETER</u></b>	<b><u>BRAKE ADJUSTMENT LIMIT</u></b>
A	6 15/16	1 3/8
B	9 3/16	1 3/4
C	8 1/16	1 3/4
D	5 1/4	1 1/4
E	6 3/16	1 3/8
F	11	2 1/4
G	9 7/8	2

<b><u>ROTOCHAMBER DATA</u></b>		
<b><u>TYPE</u></b>	<b><u>OUTSIDE DIAMETER</u></b>	<b><u>BRAKE ADJUSTMENT LIMIT</u></b>
9	4 9/32	1 1/2
12	4 13/16	1 1/2
16	5 13/32	2
20	5 15/16	2
24	6 13/32	2
30	1 1/6	2 1/4
36	7 5/8	2 3/4
50	8 7/8	3

<b><u>DD-3 BRAKE CHAMBER DATA</u></b>		
<b><u>TYPE</u></b>	<b><u>OUTSIDE DIAMETER</u></b>	<b><u>BRAKE ADJUSTMENT LIMIT</u></b>
30	8 1/8	2 1/4
<b>NOTE:</b> This chamber has three air lines and is found on motorcoaches.		

<b><u>WEDGE BRAKE DATA</u></b>
The combined movement of both brake shoe lining scribe marks shall not exceed 1/8 inch (3.18mm).

## **ATTACHMENT 2 - STEERING WHEEL FREE PLAY**

Steering Wheel Free Play: Steering wheel free play shall not exceed the requirements listed in the following chart:

Steering Wheel Diameter	Manual System Movement 30	Power System Movement 45
16" (41cm)	2" (5.1cm)	4 1/2" (11.5cm)
18" (46cm)	2 1/4" (5.4cm)	4 3/4" (12cm)
20" (51cm)	2 1/2" (6.4cm)	5 1/4" (13.5cm)
22" (56cm)	2 3/4" (7cm)	5 3/4" (14.5cm)



## **ATTACHMENT 3 – INSPECTION METHODS**

These inspection methods help clarify the normal practice for inspecting each of the previous inspection items.

### **10.00 BRAKE SYSTEM**

#### **10.01 ADJUSTMENT**

The inspector shall ensure that the brakes are released, mark the pushrod next to the brake chamber or scribe the brake shoe next to the brake drum (wedge brakes). Make a service brake application measured using a full brake application with the service reservoirs between 90 psi-100 psi. make a second mark next to the brake chamber or scribe a mark on the brake shoe next to the brake drum (wedge brakes) then measure the push rod travel or brake shoe travel (wedge brakes). Refer to ATTACHMENT 1-BRAKE ADJUSTMENT SPECIFICATIONS for proper brake adjustments.

#### **10.02 AIR SYSTEM**

The inspector shall be positioned to visually check the air gauges located on the instrument panel.

- A) With brakes released, the inspector shall observe the air gauges for any loss of air pressure.
- B) The inspector shall make a full service brake application and observe the air gauges for any loss of air pressure.
- C) The inspector shall pump the air pressure to below the air compressor cut-in pressure. The engine shall be started and the air pressure build up shall be measured with the engine operating at a high idle (1,500 rpm) and compared to OEM specifications.

### **10.10 BRAKE SYSTEM – HYDRAULIC**

#### **10.11 MASTER CYLINDER**

The inspector shall visually check the hydraulic fluid reservoir level and check for leaks in the master cylinder unit.

#### **10.12 PEDAL RESERVE**

With the brake pedal in the full upright position, the inspector shall measure the distance between the brake pedal and the floor or firewall. With the engine running, a single firm brake application shall be made and the distance between the brake pedal and the floor or firewall shall be measured a second time. The difference shall be recorded.

#### **10.13 POWER ASSIST UNIT**

With engine off, the inspector shall pump the brakes to exhaust all reserve. Hold firm pressure on the brake pedal and start the engine. The pedal should fall slightly. Failure of the pedal to fall slightly indicates a malfunction of the power-assist unit.

## **10.20 BRAKE COMPONENTS - AIR AND HYDRAULIC**

### **10.21 BRAKE HOSES/TUBING**

The inspector shall visually check all brake hoses and/or tubes.

### **10.22 BRAKE SHOE/PAD LINING**

The inspector shall visually inspect all brake linings. It may be necessary to remove inspection access covers, brake dust covers or, in some instances, pull wheels and drums to accomplish the inspection.

### **10.23 BRAKE DRUM/ROTOR**

The inspector shall visually inspect all brake drum/rotors. It may be necessary to remove inspection access covers, brake dust covers or, in some instances, pull wheels and drums to accomplish the inspection. Measurements should be taken in at least 2 locations.

## **10.30 PARKING BRAKE**

The inspector shall set the parking brake and attempt to move the bus ahead in drive gear. The parking brake should hold the bus.

## **10.40 STEERING SYSTEM**

The inspector shall visually check the entire steering system.

### **10.41 STEERING COLUMN/WHEEL**

- A) The inspector shall visually examine all u-bolts and positioning parts. The inspector shall examine all u-joints while the steering wheel is being rotated in a back and forth action to determine looseness in the u-joint.
- B) The inspector shall visually examine all fasteners for any worn, missing or damaged parts.
- C) The inspector shall manually rotate the steering wheel in a back and forth method to determine securement of the steering wheel.
- D) The inspector shall measure free play with engine running for power steering.

### **10.42 FRONT AXLE BEAM**

The inspector shall visually examine the front axle beam for cracks or welded repair.

### **10.43 STEERING GEAR BOX**

The inspector shall visually examine the steering gear box mounting bolts, cracks in the gear box or mounting bracket, or obvious welded repairs.

### **10.44 PITMAN ARM**

The inspector shall examine the pitman arm and output shaft connection, while the steering wheel is being rotated in a back and forth motion, for looseness in the joint. The inspector shall also visually examine the pitman arm for weld repairs.

#### 10.45 POWER STEERING

The inspector shall manually manipulate the auxiliary power assist cylinder to check for looseness. The inspector shall start the bus and rotate the steering wheel in a back and forth action to ensure the power steering pump is operable.

#### 10.46 BALL/SOCKET JOINTS

With the bus on the ground, the inspector shall examine the ball joint nut stud for movement while the steering wheel is being rocked in a back and forth action. With the bus lifted in the air, the inspector shall check for lateral and vertical movement by grasping the tie rod and attempting to laterally and vertically move the ball joint (rotational movement will not be considered). The inspector shall examine the ball/socket joint for weld repairs.

#### 10.47 TIE RODS/DRAG LINKS

The inspector shall visually examine all clamps, clamp bolts, and threaded joint on the tie rod and drag links for looseness.

#### 10.48 NUTS

The inspector shall visually examine all tie rods, pitman arm, drag link, steering arm and tie rod arm for looseness and missing fasteners.

#### 10.49 HOSES/FLUIDS

The inspector shall visually examine the power steering fluid reservoir and hoses for leaks. The inspector shall check the power steering fluid level.

### **10.50 SUSPENSION COMPONENTS**

#### 10.51 AXLE PARTS/MEMBERS

The inspector shall visually examine all springs, spring hangers, king pins, ball joints, struts, shock absorbers, air bags, u-bolts, and other axle positioning components for missing, broken, cracked, loose or worn components.

### **10.60 CHASSIS/FRAME/UNIBODY**

#### 10.61 FRAME

The inspector shall visually inspect the entire frame.

#### 10.62 CROSS MEMBERS

The inspector shall visually inspect each frame cross member, outrigger and other structural supports.

#### 10.63 OUTRIGGERS/BODY SUPPORTS

The inspector shall visually inspect all body outriggers and body supports.

#### 10.64 BUMPERS

The inspector shall visually inspect each bumper.

## **10.70 EXHAUST SYSTEM**

### **10.71 LEAKS**

With the vehicle safely secured (in park, brakes set, wheels chocked or other method), the inspector shall examine the entire exhaust system, with the engine running, for leaks and loose components.

## **10.80 FUEL SYSTEM**

### **10.81 FUEL CONTAINER/CONNECTION**

The inspector shall visually examine the fuel tank and all components of the fuel system.

## **10.90 DRIVE SHAFT**

### **10.91 DRIVE SHAFT GUARD**

The inspector shall visually inspect and manually verify the presence, securement and proper placement of all required drive shaft guards.

### **10.92 UNIVERSAL JOINTS**

The inspector shall check for lateral and vertical movement of the universal joints by grasping the universal joint and attempting to move the joint laterally and vertically.

## **11.00 DIFFERENTIAL**

### **11.01 HOUSING**

The inspector shall visually check the differential for cracks and leaks.

## **11.10 ENGINE**

### **11.11 COMPONENTS**

The inspector shall visually examine and monitor the engine operations.

### **11.12 LEAKS**

The inspector shall visually examine the engine for any signs of fluid leaks.

## **11.20 TIRE/WHEELS/HUBS**

### **11.21 TIRE TREAD DEPTH**

The inspector shall measure the tire tread depth at 3 points, spaced equally around the tire in the same major tread groove.

### **11.22 TIRE SIDEWALL**

The inspector shall visually check each tire, on both sides, for cuts, wearing or damage that exposes plycord. Also, inspect for any bumps, bulges or knots related to sidewall or tread separation.

### 11.23 TIRE INFLATION

The inspector shall physically measure tire air pressure on any tire that appears low.

### 11.24 TIRE TYPE

The inspector shall examine all tires to ensure that the load range and size meet or exceed manufacturers recommendations for the bus. The inspector shall examine all tires to ensure that all tires on the same axle match.

### 11.25 WHEELS/RIMS/SPIDERS

The inspector shall visually inspect each wheel, rim and spider for broken, missing, damaged or loose nuts, bolts, studs, and lugs. Each wheel/rim shall be visually inspected for cracks, proper seating, damage or welds.

### 11.26 HUB

With front wheels raised, alternately apply sufficient inward force to upper and lower edges of tire to obtain maximum travel. Measure play at lower out board edge of tire. Spin tire and listen for noise in wheel bearing.

## 11.30 AISLE

### 11.31 CLEARANCE

The inspector shall measure the width of each aisle for compliance;

12 inches minimum at seat cushion

15 inches minimum at top of seat backs

12 inches minimum to emergency doors

30 inches minimum from wheelchair or mobility aid position to closest emergency door and lift area

### 11.32 OBSTRUCTION

The inspector shall visually inspect all aisles and exits.

## 11.40 ELECTRICAL

### 11.41 WIRING

The inspector shall examine all visible wiring and electrical components.

## 11.50 BATTERY

### 11.51 CONDITION

The inspector or bus operator shall attempt to start bus.

### 11.52 WIRES

The inspector shall examine the wiring leading from the battery for loose, corroded or exposed wires.

#### 11.53 BATTERY SECUREMENT

The inspector shall visually and manually check to see that the battery is secured to prevent movement.

### 11.60 WINDSHIELD WIPERS

#### 11.61 OPERATION

The inspector shall visually check for presence of all required windshield wipers. With wipers operating, inspector shall verify normal wiper operation.

### 11.70 BODY INTERIOR

#### 11.71 PANELS

The inspector shall visually inspect all interior panels for sharp edges, loose or protruding panels, which may cause injury.

#### 11.72 FLOORS

The inspector shall visually inspect the floor for perforations and openings.

#### 11.73 STEP WELL

The inspector shall visually and manually check to ensure that all parts of the step well are supported and undamaged.

#### 11.74 STEP TREAD

The inspector shall visually examine the step treads.

#### 11.75 HANDRAIL

The inspector shall visually check for required handrail(s) and shall examine all handrails for compliance with handrail safety recalls.

#### 11.76 SEATS/BARRIERS

The inspector shall visually and manually check each seat and barrier for securement, material integrity and compliance with FMVSS No. 222, *School Bus Passenger Seating and Crash Protection*.

#### 11.77 SEAT(DRIVER)

The inspector shall ensure that the driver's seat has a full range of motion and locks securely in any position. The inspector shall visually and manually check the driver's restraint assembly for proper assembly, attachment and driver securement.

#### 11.78 DOOR (ENTRANCE)

The inspector shall operate the entrance door through the full range of motion ensuring proper operation and that the handle locks in the closed position. The inspector shall examine the entrance door for locks, padlocks or other non-OEM locking device.

#### 11.79 DOORS (EMERGENCY EXITS)

The inspector shall manually operate each emergency door for ease of operation as designed and to insure operation of the warning device and hold open device. The inspector shall examine the emergency door for locks, padlocks or other non-OEM locking device.

#### 11.80 WINDOWS

The inspector shall visually inspect each windshield and window.

#### 11.81 WINDOWS (EMERGENCY EXITS)

The inspector shall manually operate each emergency window for ease of operation as designed and to ensure operation of the warning device.

#### 11.82 DEFROSTERS

The inspector shall activate each defroster to check for proper operation.

#### 11.90 BODY EXTERIOR

##### 11.91 PANELS/RUB RAILS/TRIM

The inspector shall visually inspect each body part, panel, rub rails and trim piece for loose, torn, dislocated or protruding part, which may snag or catch clothing or otherwise cause a hazard.

##### 11.92 COMPARTMENT DOORS

The inspector shall manually and visually inspect each engine, battery, luggage or other door for proper securement and operation.

##### 11.93 MIRRORS

The inspector shall visually examine all mirrors to ensure all are present, as required, and examine for breakage and discoloration. The inspector shall examine each mirror to ensure it will hold a set adjustment.

#### 12.00 LAMPS AND SIGNALS

##### 12.01 LAMPS

The inspector shall check all lamps for proper operation.

##### 12.02 HORN

The inspector shall verify normal horn operation.

##### 12.03 GAUGES/BRAKE WARNING

The inspector shall examine all gauges for proper operation and shall cause all brake failure warning lamps and/or low air warning indicators to operate so proper operation may be verified.

#### 12.04 STOP ARM/OPTIONAL CROSSING DEVICE

The inspector shall cause each required stop arm(s) and/or each crossing control device to extend verifying normal operation.

### **12.10 EMERGENCY EQUIPMENT**

#### 12.11 FIRE EXTINGUISHER

The inspector shall visually check for compliance and securement.

#### 12.12 OTHER STATE REQUIRED EQUIPMENT

Follow state criteria.

### **12.20 WHEELCHAIR EQUIPPED VEHICLES**

The inspector shall visually inspect and operate all wheelchair lifts, securement systems and all required wheelchair occupant restraint systems.



# **APPENDICES**

## **A-G**



# **APPENDIX A**

## **Terms and Definitions**



## APPENDIX A

### Glossary of Terms and Definitions

#### INTRODUCTION

This glossary was developed with three purposes in mind:

1. To provide easy access to the definition of terms used or referenced within the document;
2. To consolidate, in one resource, the acronyms, abbreviations and standard terms commonly used in the industry; and
3. To promote consistency throughout the industry by providing standard definitions or preferred usages for terms that may be used differently in different parts of the country.

The glossary is not intended to be all-inclusive. There are and will be terms that are excluded and definitions that differ from regional usages. It is an attempt to reflect the language of student transportation, which, like all language, is ever-changing.

**Access panel:** A body panel which must be moved or removed to provide access to one or more serviceable components.

**Accessibility:** Ability of vehicles or facilities to accommodate people with mobility impairments.

**Accident:** A loss involving personal injury or property as follows:

- (1) A motor vehicle collision involving a school bus, a school activity bus or a school tripper bus, resulting in any personal injury or death or any disabling damage to one or more motor vehicles requiring the vehicle(s) to be transported away from the scene by a tow truck or other vehicle;
- (2) A collision involving any vehicle with any student at any time during the loading or unloading process of the school bus, school activity bus, or school tripper bus; or
- (3) An injury to any student inside the school bus, school activity bus, or school tripper bus as a result of negligent/unsafe acceleration, deceleration, or other movement of the bus.

**Preventable:** A crash that could have been prevented by reasonable action on the part of the school bus driver.

**Reportable:** A crash required to be reported under FMCSR (i.e. a crash involving a CMV on a public road in which there is a fatality or an injury treated away from the scene, or that requires a vehicle to be towed from the scene).

**Activity trip:** The transportation of students to any event sanctioned for student attendance or authorized by an officer, employee or agent of a public or private school, other than to-and-from school transportation. (See also *field trip*.)

**ADA:** The Americans with Disabilities Act, PL 101-336, 42 USC 12101, *et seq.* When referenced in regard to student transportation, ADA generally refers to the specifications of 49 USC 38, Americans with Disabilities Act Accessibility Specification for Transportation Vehicles.

**Adaptive device:** Any item or piece of equipment used to increase, maintain or improve functional capabilities of children with disabilities; also known as *assistive technology device*.

**Aide:** (See *attendant*.)

**Alcohol:** The intoxicating agent in beverage alcohol, ethyl alcohol, or other low molecular weight alcohols including methyl and isopropyl alcohol.

**Allowable alternate vehicle:** A vehicle designed for carrying eleven or more people, including the driver, that meets all the Federal Motor Vehicle Safety Standards applicable to school buses except 49 CFR 571.108 and 571.131. (See also *Multifunction School Activity Bus*.)

**Alternately flashing signal lamps:** A system of red or red and amber signal lamps mounted horizontally both front and rear, intended to identify a vehicle as a school bus and to inform other users of the highway that the bus is about to stop or is stopped to load or unload children; also known as *stop signal lamps*, *SOS lights* or *school bus traffic warning lights*.

**Alternative-fuel vehicle (AFV):** A vehicle designed to operate on an energy source other than petroleum-based gasoline or diesel fuel. Such fuels include, but are not limited to, CNG, LNG, LPG, and electricity.

**Bi-fuel:** A vehicle designed to operate on two different fuels, but not simultaneously.

**Dual fuel:** A vehicle designed to operate on a mixture of two different fuels.

**Hybrid power:** The use of two or more power sources to provide the motive force for the vehicle (e.g. electricity to drive the wheels with internal combustion to supplement the battery).

**Anchorage point:** The point of attachment of a securement system or occupant restraint to the vehicle structure.

**ANPRM:** Advanced Notice of Proposed Rulemaking. Notice published in the *Federal Register* by a federal agency, such as NHTSA, requesting information and inviting comment on a proposed change of regulation.

**ANSI:** American National Standards Institute, an organization which administers and coordinates the development of voluntary industry standards.

**Antilock brakes:** Brake systems with sensors that automatically control the degree of wheel slip during braking and that relieve brake pressure on wheels that are about to lock up brakes; also known as *ABS*.

**Aspect ratio:** Percentage used to express the ratio of a tire's height to its width; also known as *tire profile*.

**Assessment team:** A group of persons, including the parent or guardian of a student with disabilities, who develop a profile of the student in terms of his or her mental and physical functioning in order to determine the student's eligibility for special education. (See also *MDC*.)

**Assistive device:** (See *adaptive device*.)

**ASTM:** ASTM International (originally known as the American Society for Testing and Materials), a voluntary standards development organization and a source for technical standards for materials, products, systems and services.

**Attendant:** A person assigned to assist one or more individual student(s) with special needs on a school bus or school vehicle; also known as *aide* or *paraprofessional*. (See also *monitor*.)

**BAC:** Blood or breath alcohol concentration; the measure used to determine alcohol impairment.

**BAT:** Breath Alcohol Technician; an individual who instructs and assists persons in the alcohol testing process and operates an EBT.

**Behavior management:** Methods of influencing student conduct on the school bus.

**Biodiesel:** Vehicle fuel made from plant or animal matter and used alone or mixed with diesel fuel in engines. B100 or “neat biodiesel” refers to the pure form. Biodiesel can be mixed with petrodiesel in any proportion, but the most common form is B20, which is 20% biodiesel and 80% petrodiesel.

**Bloodborne Pathogens:** Common name for standards adopted by OSHA in 29 CFR 1910, to protect workers against the health hazards of exposure to blood and other potentially infectious body fluids or materials; also refers to the pathogenic microorganisms present in human blood.

**Boarding:** The process of loading passengers into a school bus.

**Body fluids cleanup kit:** Package of materials including, but not limited to, latex gloves, disposal bag and absorbent material, used to clean up spills of potentially infected bodily fluids, under OSHA’s Bloodborne Pathogens regulations and Universal Precautions practices; also known as *hygiene kit*.

**Booster seat:** A firm platform, used with a lap-shoulder belt, that raises the child so that the height of his thighs and shoulders are closer to those of an adult and helps route both portions of the lap-shoulder belt to fit the smaller body; also called *belt-positioning booster*.

**Brake:** A device or mechanism used to retard and stop the speed of a moving vehicle or to prevent the movement of a stopped vehicle.

**Emergency brake:** A mechanism designed to stop a motor vehicle after a failure of the service brake system.

**Foundation brake:** An assembly of the non-rotational components of a brake including its mechanism for developing a frictional force.

**Retarder:** An auxiliary braking device used to reduce brake wear and/or improve braking performance.

**Service brake:** The primary mechanism designed to retard and stop a moving vehicle.

**Parking brake:** A mechanism designed to prevent the movement of a stationary motor vehicle.

**Brake fade:** A condition that occurs as brakes become less effective.

**Bus:** A motor vehicle with motive power, except a trailer, designed for carrying more than ten (10) persons.

**Activity bus:** A bus owned, leased or contracted by a school district and regularly used to transport students on field trips, athletic trips or other curricular or extracurricular activities, but not used for to-and-from school transportation; must meet all FMVSSs for school buses.

**Charter bus:** A bus that is operated under a short-term contract with a school district or other sponsor who has acquired the exclusive use of the vehicle at a fixed charge to transport students to a school-related event.

**DOT bus:** A school bus that meets the FMCSR standards for interstate transportation set forth in 49 CFR 390.

**Intercity bus:** A large bus with front doors only, high-back seats and under-floor luggage storage for high-speed, long distance trips; also known as *motorcoach* and *over-the-road coach*.

**Nonconforming bus:** Any vehicle designed to carry more than ten (10) passengers that is used to transport students to or from school or school-related activities which does not meet the federal standards specific to school buses.

**School bus:** A bus owned, leased, contracted to or operated by a school or school district and regularly used to transport students to and from school or school-related activities, but not including a charter bus or transit bus. A school bus must meet all applicable FMVSSs and is readily identified by alternately flashing lamps, National School Bus Yellow paint, and the legend "School Bus," except as may be provided for the multifunction school activity bus.

**Type A:** A Type "A" school bus is a conversion or bus constructed utilizing a cutaway front-section vehicle with a left side driver's door. This definition includes two classifications: Type A-1, with a Gross Vehicle Weight Rating (GVWR) of 14,500 pounds or less; and Type A-2, with a GVWR greater than 14,500 and less than or equal to 21,500 pounds.

**Type B:** A Type "B" school bus is constructed utilizing a stripped chassis. The entrance door is behind the front wheels. This definition includes two classifications: Type B-1, with a GVWR of 10,000 pounds or less; and Type B-2, with a GVWR greater than 10,000 pounds.

**Type C:** A Type "C" school bus is constructed utilizing a chassis with a hood and front fender assembly. The entrance door is behind the front wheels; also known as a *conventional school bus*. This type also includes cutaway truck chassis or truck chassis with cab with or without a left side door and a GVWR greater than 21,500 pounds.

**Type D:** A Type "D" school bus is constructed utilizing a stripped chassis. The entrance door is ahead of the front wheels; also known as *rear or front engine transit style school buses*.

**Multifunction School Activity Bus (MFSAB):** "A school bus whose purposes do not include transporting students to and from home or school bus stops," as defined in 49 CFR 571.3. This subcategory of school bus meets all FMVSS for school buses except the traffic control requirements (alternately flashing signal and stop arm).



**Specially equipped:** A school bus designed, equipped, or modified to accommodate students with special needs.

**School activity bus:** Any motorcoach other than a school bus or transit bus used for the transportation of any students enrolled in a public or private school at, or below, the 12<sup>th</sup> grade level, to or from school-related activities.

**School tripper bus:** Any motor vehicle routed by, or in the vicinity of, a public or private school, and is used for to- or from-school transportation of any student enrolled in that public or private school at, or above, the ninth-grade level, operated or contracted by, and under the exclusive jurisdiction of a publicly owned or operated transit system.

**Transit bus:** A bus designed for frequent stops, with front and back-center doors and low-back seating, operated on a fixed schedule and route to provide public transportation by indiscriminately taking on passengers at designated bus stops.

**Bus body:** The portion of a bus that encloses the occupant space exclusive of the bumpers, the chassis frame, and any structure forward of the forward-most point of the windshield mounting.

**Bus pass:** Authorization to ride a school bus other than the student's assigned bus; or prepayment for transit bus rides.

**Bus yard:** An area for storage and maintenance of buses.

**CAA:** Clean Air Act; also known as CAAA, the Clean Air Act Amendments of 1990.

**Cam Wrap:** A seat-mounted system for attaching a safety harness to a school bus seat.

**Capacity:** (See *seating capacity*.)

**Capital costs:** Long-term costs associated with the purchase of vehicles, buildings and property.

**Captive:** Refers to a non-removable attachment, part or fitting on a securement system.

**Carrier:** Any public school district, any public or private educational institution providing preschool, elementary or secondary education, or any person, firm or corporation under contract to such a district or institution, engaged in transporting students.

**Casualty insurance:** (See *liability insurance*.)

**CDIP:** Commercial Drivers Instructional Permit. The learner's permit that a CDL applicant receives when he/she passes the knowledge tests; it allows the applicant to drive a CMV when accompanied by a driver with a CDL.

**CDL:** Commercial Drivers License.

**CFR:** Code of Federal Regulations.

**Chassis:** Vehicle frame with all operating parts, including engine frame, transmission, wheels and brakes.

**Chassis starting interlock circuit:** A device which prevents the engine of a bus from starting if any of the emergency exits are locked or not fully closed and latched.

**Clean diesel:** A combination of improved emission controls and cleaner-burning diesel fuel (see *ULSD*) that significantly reduces the pollutants from diesel engines. Can refer to new vehicles that meet EPA's 2007 standards or to older vehicles retrofitted with emission control technology.

**CMV:** Commercial Motor Vehicle. A motor vehicle defined in 49 CFR 390.5.

**CMVSA:** Commercial Motor Vehicle Safety Act of 1986; among other things, authorization for CDL.

**CNG:** Compressed natural gas.

**Common carrier:** A public bus, train or airplane that travels on a prescribed route and schedule, and accepts passengers indiscriminately.

**Communicable disease:** Any illness that can be transmitted from one person to another, including most common childhood diseases, the common cold and serious illnesses, such as hepatitis and AIDS.

**Community transportation:** Services that address all transit needs of a community, including general and special populations, such as the elderly and disabled.

**Companion animal:** An animal trained to provide assistance for persons with disabilities; can be a guide animal, assistive animal or service animal.

**Completed vehicle:** A vehicle that requires no further manufacturing operation to perform its intended function other than the addition of readily attachable components, such as mirrors or tire and rim assemblies, or minor finishing operations such as painting.

**Conduct report:** A form authorized by school officials for use by drivers to report instances of unacceptable behavior by school bus passengers; also known as *discipline report*.

**Continuum of services:** The range of possible options, from least restrictive to most restrictive, available to students with disabilities for transportation services.

**Conspicuity:** The ability of an object to be noticed and recognized without any confusion or ambiguity (SAE J1967).

**Crash: school bus:** (1) A motor vehicle collision involving a school bus with or without a student on board, resulting in any personal injury or death or any disabling damage to one or more motor vehicles requiring the vehicle(s) to be transported away from the scene by a tow truck or other vehicle; or (2) A collision involving any vehicle with any student or with a school bus at any time during the loading or unloading process. (See also *accident*.)

**Preventable:** A crash that could have been prevented by reasonable action on the part of the school bus driver.

**Reportable:** A crash required to be reported under FMCSR (i.e. a crash involving a CMV on a public road in which there is a fatality or an injury treated away from the scene, or that requires a vehicle to be towed from the scene).

**Crash test:** (See *impact test*.)

**Criminal record check:** The investigation of a person's criminal history through submission of fingerprints to state and/or federal authorities; also known as *background check*.

**Crossing arm:** A device attached to the front bumper of a school bus that is activated during loading and unloading and designed to force the students to walk far enough away from the front of the bus to be seen by the driver; also known as *crossing control arm*.

**CSRS:** Child Safety Restraint System; a device meeting the requirements of FMVSS No. 213, designed for use in a motor vehicle to restrain, seat or position a child who weighs less than 50 pounds; also known as *child safety seat* and *car seat*.

**Curb cut:** Area where the street curb has been cut and sloped to allow the sidewalk to lead smoothly to the roadway.

**Curb weight:** The weight of a motor vehicle with standard equipment, maximum capacity of engine fuel, oil, and coolant and, if applicable, air conditioning and additional weight of optional engine, but without passengers.

**Danger zone:** A twelve-foot area immediately surrounding the stopped school bus.

**Deadhead:** Movement of a bus without passengers (e.g., from school to bus yard).

**Deadtime:** The period between arriving at an activity trip destination and leaving the destination for the trip home; also known as *waiting time* and *stand-by time*.

**Dealer:** Any person who is engaged in the sale and distribution of new motor vehicles or motor vehicle equipment. Refers primarily to purchasers who, in good faith, purchase any such vehicle or equipment for purposes other than resale.

**Decibel (dB):** A unit used to express the relative intensity of a sound as it is heard by the human ear. The decibel measuring scale is logarithmic. Zero (0 dB) on the scale is the lowest sound level that a normal ear can detect under very quiet ("laboratory" conditions) and is referred to as the "threshold" of human hearing. On a logarithmic scale, 10 decibels are 10 times more intense, 20 decibels are 100 times more intense, and 30 decibels are 1,000 times more intense than 1 decibel.

**Decibel "A-Weighted" (dBA):** The scale for measuring sound in decibels that assigns weights to different frequency ranges to reduce the effects of low and high frequencies in order to simulate human hearing.

**Distributor:** Any person or company primarily engaged in the sale and distribution of motor vehicles or motor vehicle equipment and/or parts for resale.

**Dispatch:** To relay service instructions to drivers.

**DNR:** Do Not Resuscitate; an order from a parent, legal guardian or court that prohibits the use of emergency measures to prolong the life of an individual.

**DOC:** Diesel oxygenation catalyst. Devices that use a chemical process to break down pollutants in the exhaust stream of diesel engines into less harmful components.

**DOT:** United States Department of Transportation.

**DOT driver:** A driver who meets the FMCSR standards, set forth in 49 CFR 391.

**Double run:** One bus making two trips over the same route each morning and afternoon (e.g. first picking up high school students and then returning for elementary students).

**Downtime:** The period when a vehicle is not in service (e.g. due to mechanical failure or scheduled maintenance).

**DPF:** Diesel particulate filter. Ceramic devices that collect particulate matter in the exhaust stream of diesel engines. The high temperature of the exhaust heats the ceramic structure and allows the particles inside to break down (or oxidize) into less harmful components.

**Driver applicant:** A person who applies for a position as a school bus driver.

**Driver training:** Instructional program designed to impart knowledge and improve the skills necessary for school bus drivers, including but not limited to knowledge of the vehicle, safe driving practices, emergency procedures and passenger control.

**In-service:** Training provided annually, or more often, to school bus-certified drivers.

**Pre-service:** Training provided to driver applicants prior to school bus certification and/or transporting students.

**Driver qualifications:** Restrictions of state and federal law which determine a person's eligibility to become a school bus driver (e.g. age limits, physical condition, criminal record, driving history, etc).

**DRL:** Daytime running lamps; Head lamps that operate automatically at a reduced voltage during the day to increase the vehicle's visibility; also known as *daytime running lamps*.

**Drug:** Any substance other than alcohol considered to be a controlled substance listed on schedules I through V in 21 CFR 1308.

**Dry run:** A trip on a route without student passengers for driver training or familiarization of the route.

**Dual brake system:** (See *split brake system*.)

**Dual fuel system:** (See *alternative fuel*.)

**DVIR:** Driver vehicle inspection report. Federal, state or local approved form for reporting results of pre-trip and post-trip inspections; also known as *daily vehicle inspection report* and *pre-trip inspection form*.

**Dynamic testing:** The process of subjecting vehicle, mobility aid, or mobility aid/securement system components to a simulated crash condition.

**EAP:** Employee Assistance Program; a program of education and counseling required by 49 CFR 391 as part of a carrier's drug and alcohol testing program; may also include optional rehabilitation services.

**EBT:** Evidential Breath Testing device; a device approved by NHTSA for testing drivers for alcohol use.

**EDR:** Event Data Recorder; a device which records vehicle functions (e.g. speed change during a crash).

**EHA:** The Education for all Handicapped Children Act, passed in 1975 as P.L.94-142. (See also *IDEA*.)

**EPA:** The United States Environmental Protection Agency.

**Early bus:** A bus scheduled to run prior to the regular morning run (e.g. to take children to day care programs located in schools).

**Early intervention service:** Education and related services provided to infants and toddlers from birth through two years of age.

**Effective date:** The date at which a regulation or standard takes effect, on or after which compliance is legally required.

**Elastomer:** An elastic substance occurring naturally, as natural rubber, or produced synthetically (e.g., butyl rubber, vinyl, etc.).

**Electronic voice communication system:** A means by which the driver of a vehicle can communicate with a dispatcher or other person at a remote location (e.g., two-way radio, cellular phone).

**Emergency roof exit:** An opening in the roof of the bus meeting the requirements of FMVSS No. 217 which provides emergency egress and sometimes ventilation; also known as *roof hatch*.

**Emergency response plan:** A detailed approach to identifying and responding to potential accidents involving hazardous substances; required for every community by the Emergency Planning and Right-to-Know Act of 1986.

**EOBR:** Electronic On-Board Recorders. An electronic device that collects, stores, and displays data relative to driver and vehicle performance, including such elements as location, time, speed, and distance traveled.

**Ergonomics:** The study of the design of equipment to reduce human fatigue and discomfort.

**Ethanol:** Grain alcohol, distilled from fermented organic matter and used as a vehicle fuel.

**Evacuation drill:** Performance of a mock school bus evacuation in order to teach students proper emergency procedures and to provide practice in the use of emergency exits; also known as *bus safety drills*.

**Extended-year service:** Transportation provided for students subsequent to the end of the traditional school year; especially, transportation as a related service for students with disabilities beyond the normal school year in accordance with the IEP.

**Extraboard driver:** (See *substitute driver*.)

**FAPE:** Free Appropriate Public Education it refers to special education and related services, including transportation, provided at public expense in accordance with a child's IEP (34 CFR 300.13 and 300.121).

**FBI background check:** The national criminal record check.

**FERPA:** The Family Educational Rights and Privacy Act of 1974, 20 USC 1232, which requires confidentiality of student records in public schools, but allows access to necessary information regarding student disabilities and/or health needs to those who have a need to know, including school bus drivers.

**FHWA:** Federal Highway Administration, an agency of the U.S. Department of Transportation.

**Field trip:** The transportation of students to an event or destination which is an extension of classroom activity (i.e., a part of the curriculum ). A field trip is one type of *activity trip*.

**Final Rule:** Notice published in the *Federal Register* by a federal agency announcing a new or changed regulation.

**Final stage manufacturer:** A person who performs such manufacturing operations on an incomplete vehicle that it becomes a completed vehicle.

**First aid:** Emergency treatment given to an ill or injured person before regular medical help is available.

**Fixed route:** Transportation service that runs on regular, prescheduled routes, usually with bus schedules and designated bus stops.

**FMCSA:** Federal Motor Carrier Safety Administration; an agency of the U.S. Department of Transportation; formerly the Office of Motor Carrier Highway Safety within the Federal Highway Administration.

**FMCSR:** Federal Motor Carrier Safety Regulations, 49 CFR 383, 390-397, and 399; motor vehicle safety and construction standards under FMCSA that apply to commercial motor vehicles and drivers transporting passengers in interstate commerce.

**FMLA:** Family and Medical Leave Act; requires employers to grant time off to employees for medical reasons or to care for family members.

**FMVSS:** Federal Motor Vehicle Safety Standards, 49 CFR 571; construction standards developed and enforced by NHTSA that apply to all new motor vehicles and items of motor vehicle safety equipment.

**Forward control bus:** a school bus in which more than half of the engine length is rearward of the foremost point of the windshield base and the steering wheel hub is in the forward quarter of the vehicle length; also known as *transit-style*. (See also “School Bus, Type D.”)

**Forward-facing:** Installation of the securement system in such a way that the mobile seating device and its occupant face the front of the vehicle when secured.

**Four-point tiedown:** A securement system in which four strap assemblies attach to the wheelchair frame at four separate points and anchor to the vehicle floor at four separate points.

**FSS:** Fire suppressant system; a fire extinguisher system installed in the engine compartment of a vehicle and activated automatically in response to a fire sensor or manually in response to an alarm.

**FTA:** Federal Transit Administration, part of U.S. Department of Transportation; formerly Urban Mass Transit Administration (UMTA).

**Fuel injection:** System that uses no carburetor but sprays fuel directly into cylinders or into the intake manifold.

**Glazing:** The glass or glass-like portion of a window.

**Laminated glass:** Any glazing material that consists of one or more sheets of glass and an inboard-facing surface sheet of plastic, the components being held together by intervening plies of plastic interlayer or by the self-bonding characteristic of the inboard plastic layer.

**Safety glass:** Glazing material constructed, treated or combined with other materials so as to reduce, in comparison with ordinary glass, the likelihood of injury to persons as a result of contact with the glass, either broken or unbroken.

**Storm window:** Two or more sheets of safety glazing material separated by an airspace to provide insulating properties and fixed in a common frame or mounting.

**Tempered glass:** Glazing which consists of glass that has been tempered to meet the properties of safety glass.

**GAWR:** Gross axle weight rating; the value specified by the manufacturer as the load-carrying capacity of a single axle system, as measured at the tire-ground interfaces.

**GPS:** Global Positioning System. A satellite tracking system that enables a receiver to compute the position and speed of a vehicle.

**Guideline 17:** A highway safety program guide for student transportation safety issued by NHTSA in 23 CFR 1204; formerly Standard 17.

**GVWR:** Gross vehicle weight rating; the value specified by the vehicle manufacturer as the load-carrying capacity of a single vehicle as measured at the tire-ground interfaces.

**Handrail inspection tool:** A device formed by tying a half-inch hex nut to a 36-inch cord, used to inspect school bus handrails and other areas for possible snagging hazards.

**Hazard lamps:** Lamps that flash simultaneously to the front and rear on the right and left sides of a vehicle, used to indicate caution; also known as *four way flashers*.

**Head protection zone:** The empty space above and in front of each school bus passenger seat which is not occupied by side wall, window or door structure, the dimensions of which are detailed in FMVSS No. 222.

**Head Start:** A program initiated in 1965 to provide comprehensive child development services to pre-school children of predominantly low-income families.

**Headsign:** A sign above the windshield of the bus which can be changed from *School Bus* to other wording, such as *Charter*.

**Health care plan:** A plan of action used to outline the care for a medically fragile individual.

**Highway:** Any public highway, road, street, alley, parkway or other place open to public motor vehicle travel.

**Horsepower:** The measurement of an engine's ability to do work. One horsepower is the ability to lift 33,000 lbs. one foot in one minute.

**Hours of service:** The consecutive or cumulative period of time that a commercial driver may be on duty; for details see reference in the sub-section, "Transportation Other Than To and From School" in the OPERATIONS section of this document.

**HOV:** High Occupancy Vehicle; a vehicle that can carry two or more passengers.

**ICC:** The former Interstate Commerce Commission, the economic regulation agency within the Department of Transportation. The agency was disbanded in 1997 as a result of economic deregulation, and most functions were transferred to the Federal Highway Administration.

**IDEA:** The Individuals with Disabilities Education Act, passed in 1990 as P.L. 101-476, to replace the EHA. (20 USC 1400 *et. seq.*) Also the regulations at 34 CFR Parts 300 and 303.

**IEP:** Individualized Education Program; a written statement developed by an assessment team for each child with a defined disability, as required under IDEA.

**IFSP:** Individualized Family Service Plan; a written plan for providing early intervention services to an eligible child and his or her family under Part H of IDEA.

**Impact test:** A simulated crash condition which evaluates the ability of a vehicle or any component or device to withstand crash forces; also known as *sled test* and *crash test*.

**Inclusion:** Integration of a student with disabilities into a regular classroom and into a regular school bus; also known as *mainstreaming*.

**Incomplete vehicle:** An assemblage consisting, as a minimum, of frame and chassis structure, power train, steering system, suspension system and braking system (to the extent that those systems are to be part of the completed vehicle) and requiring further manufacturing operations other than the addition of readily attachable components, such as mirrors and tire and rim assemblies, or minor finishing operations such as painting, to become a completed vehicle.

**Incomplete vehicle manufacturer:** A manufacturer of an incomplete vehicle, i.e., a person who performs the first stage of manufacture on a vehicle manufactured in two or more stages of manufacture. (See also intermediate manufacturer and final-stage manufacturer.)

**Injury incident, school bus:** Any non-crash event resulting in injury to a person while in the bus or while boarding/leaving the bus.

**In loco parentis:** (See loco parentis.)

**Inspection:** A close examination of a motor vehicle performed in accordance with local, state and/or federal requirements by an authorized agent of the local, state or federal government.

**Integrated restraint system:** A system in which the occupant restraint for an individual in a wheelchair/mobility aid connects directly to, and is dependent upon, the mobility aid's securement system's rear strap assemblies.



**Intermediate manufacturer:** A person, other than the incomplete vehicle manufacturer or the final-stage manufacturer, who performs manufacturing operations on an incomplete vehicle.

**International symbol of accessibility:** A white emblem on blue background used to indicate that a vehicle can accommodate individuals with disabilities.

**ITP:** Individualized Transportation Plan; a plan established to transport a student with a defined disability.

**Kneeling bus:** A bus on which the front or rear end is lowered to allow easier access for passengers with disabilities.

**Lap belt:** A Type 1 belt assembly meeting the requirements of FMVSS No. 209 and intended to limit movement of the pelvis.

**Lap/shoulder belt:** A Type 2 belt assembly meeting the requirements of FMVSS No. 209 and intended to limit the movement of the pelvis and upper torso.

**Lap tray:** An accessory for a wheelchair or other mobile seating device, to offer support and convenience for the occupant.

**LATCH system:** Lower Anchors and Tethers for Children system. Incorporates standardized hardware in vehicle seats including the UCRA lower anchorages and the upper tether anchorage. It is designed to allow installation of CSRS without using the vehicle's seat belt system. All CSRSs sold in the US after 2002 are required to be LATCH compatible.

**Late bus:** A bus scheduled to leave school at a time subsequent to the end of the school day, usually to provide transportation for students involved in after-school activities.

**Layover time:** Time built into a trip schedule between arrival and departure.

**LEA:** Local Education Agency.

**Left:** Left position is determined from the normal driving position as seated in the driver's seat looking in the direction of forward travel.

**Liability insurance:** Protection against the claims of others for injury or property damage; also known as *casualty insurance*.

**Life cycle procurement:** A procurement contract based on both the initial capital cost and the cost of operation over the life of a vehicle, intended to identify the most cost-effective time to replace an asset.

**Lift:** (See *power lift*.)

**Live time:** The time when students are in the bus, beginning when the first passenger boards and ending when the last passenger leaves.

**LNG:** Liquefied Natural Gas.

**Load:** To pick up students at a designated bus stop or at school.

**Load factor:** The ratio of passengers actually carried to the vehicle's passenger capacity.

**Loading zone:** Any area where students are boarding or leaving a school bus.

**Loco parentis (in loco parentis):** Legal term meaning the formal authority of a person to act for or in place of the parent of a minor child.

**Low-bid procurement:** Competitive procedure in which the lowest bidder is awarded the contract. See also *Performance-based procurement*.

**Low-floor vehicle:** A bus in which the floor and entrance are closer to the ground, for easier access by students with disabilities or pre-schoolers.

**Longitudinal:** Parallel to the longitudinal centerline of the vehicle, front to rear.

**LPG:** Liquefied Petroleum Gas; also known as *propane*.

**LRE:** Least Restrictive Environment; a concept embodied in IDEA which requires that children with disabilities be integrated as fully as possible into situations and settings with their non-disabled peers.

**Mainstreaming:** (See *inclusion*.)

**Manufacturer:** Any person engaged in the manufacturing or assembling of motor vehicles or items of motor vehicle equipment, including any person importing motor vehicle equipment for resale.

**MDC:** Multi-Disciplinary Conference; an assessment meeting for a student with disabilities which leads to an IEP. (See also *assessment team*.)

**MDT:** Multi-Disciplinary Team; also known as PET, Pupil Evaluation Team: (See also *assessment team*.)

**Mediation:** Efforts by a third party to bring about agreement between dissenting parties (e.g. labor and management or parents and school administration); usually less formal than arbitration.

**Medical support equipment:** Portable equipment used by students to maintain life functions, such as oxygen bottles, intravenous or fluid drainage apparatus.

**Medically fragile:** Refers to students who require specialized technological health care procedures for life support and/or health support.

**MFSAB:** (See *Multifunction School Activity Bus* under *Bus*.)

**Minibus:** A small school bus, usually a Type A-1 or A-2 or Type B-1 or B-2.

**Minivan:** A multi-purpose vehicle (MPV) designed to carry seven to ten passengers.

**Mirrors:** The system of mirrors required to be installed on school buses in accordance with FMVSS No. 111 and applicable state laws.

**Crossview:** Convex mirrors mounted on the front of the school bus and designed for student detection during loading and unloading, also known as *System B mirrors* and including *elliptical, quadri-spherical, banana, or standard convex* mirrors.

**Driving:** Flat and convex mirrors mounted on each side of the bus designed for viewing the road along the sides to the rear while driving; also known as *rearview, double nickel, west coast, or System A* mirrors.

**MIS:** Management Information System; a means of data collection for analysis by management.

**Mobility aid:** A wheelchair or other device, either battery-powered or manual, that is used to support and convey a person with a physical disability; also known as *mobile seating device*.

**Modesty panel:** A panel located in front of a seat or row of seats to preserve the modesty of the passengers, usually supported by a stanchion and cross bar, and does not meet the performance standards of a *barrier* as defined in FMVSS No. 222. Also, a short panel which extends from the bottom of a *barrier* to or near to the floor for the purpose of reducing the draft from the entrance door; also known as *kick panel*.

**Monitor:** A person assigned to assist the driver on a school bus or school vehicle. (See also *attendant*.)

**Discipline:** A monitor whose primary responsibility is to control behavior of students in the bus.

**Safety:** A monitor whose primary responsibility is to ensure the safety of students getting on and off the bus and to check the loading zone before the driver pulls out.

**Motor carrier or carrier:** The registered owner, lessee, licensee or bailee of any vehicle who operates or directs the operations of any such vehicle on either a for-hire or a not-for-hire basis.

**MPV:** Multipurpose Passenger Vehicle; any vehicle with a seating capacity of ten or fewer, including the driver, which is built on a truck chassis, or with special features for occasional off-road use.

**MRO:** Medical Review Officer; a licensed physician with knowledge of substance abuse disorders required by 49 CFR 40 to receive and evaluate laboratory results generated by a carrier's drug testing program.

**MVR:** Motor Vehicle Record of the driver; also known as *driving history*.

**NAPT:** National Association for Pupil Transportation, a membership organization comprising individuals and organizations representing all facets of school transportation.

**NASDPTS:** National Association of State Directors of Pupil Transportation Services, a membership organization comprising primarily state officials responsible for student transportation.

**National school bus yellow:** The color defined in the publication "National School Bus Color Standard" SBMTC-008.

**NDR:** National Driver Registry.

**Neutral safety switch:** A device which prevents the bus from starting unless the transmission is in neutral gear or the clutch is depressed.

**NGV:** Natural Gas Vehicle.

**NSTSP:** National School Transportation Specifications and Procedures, a publication of the National Congress on School Transportation.

**NHTSA:** National Highway Traffic Safety Administration, an agency of the U.S. Department of Transportation.

**NIST:** National Institute of Standards and Technology.

**Nominal dimension:** A dimension which exists in name only (e.g. 5/8" plywood which is actually 19/32" thick, but is 5/8" nominal thickness). The variation between the actual dimension and the nominal dimension is the result of manufacturing practices and tolerances.

**Non-conforming van:** A vehicle smaller than a bus, designed to carry seven to ten passengers and used to transport students, that does not meet FMVSS for school buses.

**NPRM:** Notice of Proposed Rulemaking; a notice published in the *Federal Register* by a federal agency of a proposed change in regulation.

**NSC:** National Safety Council.

**NSBY:** National School Bus Yellow: (See also SBMTC-008 for colorimetric specifications.)

**NSTA:** National School Transportation Association, a membership organization comprising primarily school transportation contractor companies.

**NTSB:** National Transportation Safety Board, an independent federal agency authorized by Congress to investigate accidents and to issue safety recommendations.

**Occupant:** A person who occupies space inside a school bus; refers to both passenger and driver.

**OCR:** Office of Civil Rights, an agency of the U.S. Department of Education.

**OEM:** Original Equipment Manufacturer.

**On-board monitoring system:** Computerized tracking of driver and vehicle performance, including speed, fuel consumption, etc. (See also *EOBR*.)

**Operating costs:** All costs associated with running the transportation system, which are distinct from capital costs.

**Operator:** The carrier who is responsible for running the transportation system, regardless of ownership of the vehicle.

**OSEP:** Office of Special Education Programs, an agency of the U.S. Department of Education.

**OSERS:** Office of Special Education and Rehabilitative Services, an agency of the U.S. Department of Education.

**OSHA:** Occupational Safety and Health Administration, an agency of the U.S. Department of Labor.

**OTETA:** The Omnibus Transportation Employees Testing Act of 1991, requiring drivers holding CDLs to participate in a drug and alcohol testing program.

**Out of Service:** The removal of a school bus from passenger service due to a defective condition.

**Overall vehicle width:** The nominal design dimension of the widest part of the vehicle, exclusive of signal lamps, marker lamps, outside rearview mirrors, flexible fender extensions and mud flaps, determined with the doors and windows closed and the wheels in the straight-ahead position.

**Overhang:** The distance from the center of the rear axle to the rearmost end of the body or from the center of the front axle to the forward edge of the front bumper.

**P. A. system:** A public address system which allows the driver of a bus to communicate with persons inside and/or outside the bus through a speaker installed on the inside and/or outside of the bus; also known as *external loudspeaker*.

**Parallel restraint system:** A system in which the occupant restraint lap belt anchors directly to the floor track or plates, and is independent of the wheelchair/mobility aid securement system.

**Paratransit:** Public transit service which is more flexible than a fixed-route system, commonly providing special service for elderly and disabled passengers.

**Part B:** Refers to the section of IDEA (20 USC 1400 *et. Seq.*) applicable to special education and related services for children with disabilities and to the implementing regulations at 34 CFR 300.

**Part HC:** Refers to the section of the IDEA related to early intervention services for infants and toddlers and to the implementing regulations at 34 CFR 303. Formerly referred to as Part H.

**Particulate trap:** A device on diesel buses to clean the exhaust of particulate matter. (See also *DPF*.)

**Passenger:** A person who rides in a school bus but does not operate it. (See also *occupant*.)

**Passenger compartment:** Space within the school bus interior measured from a point 30 inches ahead of the forward most passenger seating reference point (SRP) rearward to the inside surface of the rear end of the bus at the center of the rear emergency exit.

**Passenger Endorsement:** A designation (*P*) on a CDL that indicates the driver is qualified to drive a commercial passenger vehicle. Must accompany an *S* endorsement.

**Passenger miles:** The total number of miles traveled by the aggregate number of passengers on a vehicle. (Example: Two students traveling four miles would equal 8 passenger miles and five students traveling three miles would equal 15 passenger miles—totaling 23 passenger miles.)

**Performance Base procurement:** Competitive procedure in which contracts are awarded based on a combination of price and past performance; also known as *Best Value Procurement*.

**P.L.94-142:** (See *EHA*.)

**Postural support:** A seat, belt or other component used to support a child with disabilities in a desired position but not designed or intended to provide occupant restraint in a crash; also known as *positioning device*.

**Power base:** A powered, wheeled platform used to mount a seating device for carrying an individual with a disability; usually characterized by smaller diameter tires.

**Power cut-off switch:** A device that cancels all power from the vehicle batteries.

**Power lift:** A mechanized platform designed to provide access to a vehicle for an occupied mobility aid/wheelchair; also known as a *wheelchair lift*.

**Positive-locking:** A design feature of the mobility aid securement and occupant restraint system where the attachment and anchoring hardware cannot be inadvertently released or disengaged once properly installed.

**Post-trip interior inspection:** A check of the interior of the bus by the driver at the end of the run to ensure that no children or student belongings have been left behind.

**Powertrain:** The group of components used to transmit engine power to the wheels; includes engine, transmission, universal joints, driveshaft, drive axles and gears; also known as *drivetrain*.

**Pre-school:** Refers to a child between the ages of three and five years who is not yet in kindergarten or to a program serving children in that age range.

**Pre-trip inspection:** A systematic inspection of the bus by the driver before every trip or shift to ensure that the bus is in safe operating condition. The same procedure performed after the trip/shift is the *post-trip inspection*.

**Privatization:** The process of transferring the operation of public services from the public agencies to private companies or nonprofit organizations; also known as *contracting* or *outsourcing*.

**Pupil:** (See *Student*.)

**Pusher:** A school bus in which the engine is mounted in the rear of the vehicle; also known as *rear-engine bus*. (See also *School Bus, Type D*.)

**Pushout window:** A bus window that is hinged at the top or front to enable the window to be swung upward or outward relative to the side of the bus and to provide a means of emergency egress from the bus; also known as *emergency window*.

**Railroad crossing:** The intersection of a highway, street or roadway and railroad tracks; also known as *grade crossing*.

**Ramp:** An inclined plane for use between the ground and the floor of the vehicle to permit access by persons in wheelchairs/mobility aids.

**Reflective:** Refers to the property of materials that cause them, when they are illuminated, to reflect the light to some extent.

**Related services:** Transportation and other supportive services that are required to assist a child with a disability to benefit from special education.

**Remanufactured:** Refers to a vehicle component that has been structurally restored.

**RESNA:** Rehabilitation Engineering Society of North America, an organization engaged in research and development of assistive technology for persons with disabilities.

**Restraining barrier:** An assembly similar to a seat back located immediately in front of a single school bus passenger seat or row of seats to provide crash protection in accordance with FMVSS No. 222; also known as *barrier*, *crash barrier* and *seat barrier*.

**Restraint system:** A generic term for one or more devices intended to secure and protect a passenger with or without a mobility aid in a vehicle, including lap belts, lap/shoulder belts, child safety seats, safety vests, etc.

**Restraint/securement system:** (See *securement and restraint system*.)

**Retractor, automatic-locking:** A retractor incorporating adjustment by means of a positive self-locking mechanism which is capable of withstanding restraint forces.

**Retractor, emergency-locking:** A retractor that incorporates adjustment by means of a locking mechanism that is activated by vehicle acceleration, webbing movement relative to the vehicle, or automatic action during an emergency, and that is capable of withstanding restraint forces.

**Retroreflective:** Refers to material that is designed to direct light back to its source.

**RFP:** Request For Proposals; an invitation to submit a contract proposal, less restrictive than an invitation to bid on a contract.

**Ridership:** The number of passengers using a transportation system during a given time period.

**Right:** Right position is determined from the normal driving position as seated in the driver's seat looking in the forward direction of travel.

**Rim:** The part of the wheel on which the tire is mounted and supported.

**Risk management:** Practices and procedures designed to protect against losses from accidents, passenger and worker injuries, vehicle damage and other losses, and to reduce insurance costs.

**Rolling stock:** The vehicles in a transportation system.

**Roof hatch:** (See *emergency roof exit*.)

**Route:** A designated course regularly traveled by a school bus to pick up students and take them to school, or to deliver students from school to their homes or designated bus stops.

**Route miles:** The total number of miles in one or more routes in the system.

**Route sheet:** A list of all the designated stops on a route.

**Run:** A complete trip on a route. (To illustrate the difference between a run and a route: it is possible to have six daily runs on the same route, i.e., one high school, one middle school, and one elementary run both morning and afternoon.)

**Running gear:** The wheels, axles, springs, frames and other carrying parts of the vehicle.

**SAE:** Society of Automotive Engineers, the leading standards-writing organization for the automotive industry.

**SAP:** Substance Abuse Professional; a licensed physician, psychologist, social worker or alcohol and drug counselor who is required to evaluate any employee who violates a carrier's drug and alcohol testing program.

**Safety Incident:** An occurrence that represents a close call/near miss or recognized heightened level of risk to students traveling to and from school or school-related activities.

**Safe travel training:** Educational programs provided for students to teach safe procedures for travel to and from school and home and to and from school-related activities.

**Safety vest/harness:** A combination pelvic and upper torso child restraint system that consists primarily of flexible material, such as straps, webbing or similar material, and that does not include a rigid seating structure for the child. Can be used with a cam wrap on a school bus seat or with a tether in other vehicles.

**Safety patrol:** Students whose duties may include acting as crossing guards and safety assistants.

**Safety ridership training:** Educational programs provided for students to teach proper behavior while waiting for, riding in, boarding or leaving school buses; also known as *ridership programs*.

**SBMTC:** School Bus Manufacturers Technical Council; formerly the School Bus Manufacturers Institute (SBMI); a membership organization within NASDPTS which serves as a technical advisor regarding school bus technology and construction.

**School:** An educational institution for children at the pre-primary, primary, elementary, or secondary level, including nursery schools and Head Start programs, but not including day care programs.

**School bus equipment:** Equipment designed primarily as a system, part or component of a school bus, or any similar part or component manufactured or sold for replacement or as an accessory or addition to a school bus.

**School bus stop:** An area on the street or highway designated by school officials for picking up and discharging students.

**School bus traffic warning lamps:** (See *Alternately flashing signal lamps*.)

**School endorsement:** A designation (S) on a CDL that indicates the driver is licensed to operate a school bus.

**School trip:** (See *activity trip*.)

**School tripper trip:** The transportation in a school tripper bus of any student enrolled in a public or private school to or from school or to or from a school-related activity.

**School vehicle:** Any vehicle owned, leased, contracted to or operated by a school or school district and regularly used to transport students to and from school or school-related activities. Includes school buses, activity buses, vans and passenger cars, but does not include transit or charter buses.



**Scooter:** A motorized mobility aid with three wheels, handle bar or tiller and a swiveling seat.

**SEA:** State Education Agency.

**Seat:** A device designed and installed to provide seating accommodations.

**Activity seat:** A seat designed for passenger comfort with contoured seats and backs with the result that passengers' positions are distinctly separate; characterized by fixed seat backs; may have arm rests and head rests; can be manufactured to meet FMVSS No. 222.

**Bench seat:** A seat designed to accommodate more than one passenger with no apparent partitioning between positions, which is characterized by fixed legs and a fixed back (e.g., the standard school bus seat which meets FMVSS No. 222).

**Davenport seat:** A bench seat that extends from side wall to side wall at the rearmost seating position in the bus; not permitted in school buses.

**Flip seat:** A school bus bench seat designed so that the cushion flips up when the seat is not occupied, similar to a theater seat; used to provide aisle clearance, as required by FMVSS No. 217, when a passenger seat is located adjacent to a side emergency door.

**Integrated child safety seat:** A child safety seat meeting the requirements of FMVSS No. 213 which is built into and thus an integral part of a bench seat.

**Jump seat:** A seat designed to fold down to provide supplemental seating in a bus (e.g. in the aisle, in front of the door or along the side wall); not permitted in school buses.

**Reclining seat:** An activity seat with a reclining seat back; not permitted in school buses.

**Seat belt ready seat:** A bench seat meeting the requirements of FMVSS No. 222, the frame of which is designed for the installation of lap belts or CSRS attachment devices under FMVSS 210.

**Seat belt:** (See *seat restraints*.)

**Seating capacity:** The number of designated seating positions provided in a vehicle, including the driver's position. In determining seating capacity, each wheelchair securement location shall be counted as four (4) designated seating positions.

**Designed seating capacity:** The theoretical passenger capacity that a vehicle would have if it were constructed with the maximum number of seating positions according to standard seating plans; also known as *manufacturer's seating capacity*.

**Equipped Seating Capacity:** The number of designated seating positions provided in a new bus per manufacturer's body/seating plan.

**Reduced capacity:** The capacity that is achieved when one or more seats are removed from the standard design during or after manufacture of the vehicle.

**Seating position:** The space on a school bus bench seat designated for one student. The number of such positions per seat is determined by dividing the width of the seat by 15" and rounding to the nearest whole number, as described in FMVSS No. 222.

**Seating reference point:** The manufacturer's design point, with coordinates relative to the vehicle structure, which establishes the rearmost normal driving or riding position of each designated seating position and simulates the position of the pivot center of the human torso and thigh.

**Seat restraints:** A passenger restraint system incorporating lap belts or lap/shoulder belts and meeting the requirements of FMVSS Nos. 209 and 210.

**Section 402:** Section of 23 CFR that authorizes grant funds for highway safety projects.

**Section 504:** Section of the Rehabilitation Act of 1973, PL 93-112, which prohibits discrimination against individuals with disabilities by any recipient of federal funding.

**Securement points:** Locations on the base or seat frame of the wheelchair/mobility aid where the securement system should be attached.

**Securement system:** The means of securing a mobile seating device to a vehicle in accordance with FMVSS No. 222, including all necessary buckles, anchors, webbing/straps and other fasteners.

**Securement and restraint system:** The total system which secures and restrains both a wheelchair/mobility aid and its occupant; also known as *WTORS*.

**Self-insured:** Refers to a company or school district which provides reserved funds against claims or losses.

**Sensor:** An electronic device installed on a school bus for the purpose of detecting animate objects in the loading zone; also known as *object detection system*.

**Seizure:** A reaction to an electrical discharge in the brain, resulting in symptoms which can range from a blank stare of a few seconds to full convulsions.

**Shuttle:** A trip run back and forth over a short route (e.g. between two schools).

**Skid plate:** Stout metal plate attached to the underside of a vehicle to protect the oil pan, transmission, step well or fuel tank from scraping on rocks, curbs and road surface.

**Slack adjuster:** Adjustable device connected to the brake chamber pushrod that transmits brake application force and compensates for lining wear

**SOS lights:** Stop on Signal lights. (See also *alternately flashing signal lamps*.)

**SOWAT:** The Committee on Wheelchairs and Transportation, a group acting under the auspices of RESNA responsible for developing transportable wheelchair crashworthiness standards.

**Special education:** Specially designed instruction to meet the unique needs of a child with disabilities.

**Specially equipped school bus:** Any school bus designed, equipped or modified to accommodate students with special needs.

**Split-brake system:** A service brake system with two separate hydraulic circuits which, upon failure of either, retains full or partial braking ability.

**Stanchion:** An upright post or bar, usually installed from floor to ceiling in a bus, that provides support for other structural members and/or provides a hand-hold for passengers.

**State:** As used in this document, “state” shall refer to any of the 50 states and commonwealths and any United States territory, possession, or federal agency (e.g., the General Services Administration or the Department of Defense) that may consider, follow or adopt part or all of the specifications and procedures contained herein for school buses and operations.

**State director:** The chief government administrator in charge of a state’s student transportation program and responsible for oversight of regulatory functions.

**Stop arm:** A device in the form of a red octagon extending outward from the side of a school bus to signal that the bus has stopped to load or unload passengers and meeting FMVSS No. 131; also known as *stop semaphore* and *stop signal arm*.

**Stopping distance:** Braking distance plus reaction distance.

**Braking distance:** The distance a vehicle travels between the time the brakes are applied and the time forward motion ceases.

**Reaction distance:** Distance a vehicle travels during the time it takes for a driver to recognize the need to stop and to apply the brakes.

**Strobe light:** A bright short duration light that flashes as a result of an electronic discharge of electricity through a gas.

**Stroller:** A light weight folding mobility aid.

**Student:** Any child who attends a school, as previously defined.

**Student rides:** The number of students transported in a given system multiplied by the number of one-way trips in a school bus. (For example, a school district that transports 1000 students provides 2000 student rides daily or 360,000 student rides to and from school annually, assuming 180 school days. To determine the total number of student rides annually, the district would add the actual or estimated number of students transported on activity trips [times 2] to the figure above.)

**Substitute driver:** A driver who is not assigned to a regular route but is employed to provide immediate coverage, when necessary, due to driver absences or emergencies; also known as *spare driver* and *extraboard driver*.

**Surrogate wheelchair:** A wheelchair device which is subjected to impact tests to test securement and restraint systems.

**Suspension system:** The components of the vehicle that transmit the load of the vehicle’s weight from the chassis framework to the ground, including the springs, axles, wheels, tires and related connecting components.

**TDD:** Telecommunication devices for the deaf.

**Temperature control system:** The means of heating or cooling the interior of the vehicle.

**Tether:** An upper anchor strap used in addition to a seat belt to hold certain types of restraint devices in place.

**Tiedown system:** (See *securement system*.)

**Tire:** The continuous solid or pneumatic rubber elastomeric cushion encircling a wheel intended for contact with the road.

**Bias ply:** A pneumatic tire in which the ply cords extending to the beads are laid at alternate angles substantially less than 90 degrees to the centerline of the tire.

**Low profile:** A tire that has a section height that is less than 85 percent of its nominal section width (e.g., a tire with an aspect ratio of less than 0.85).

**Radial:** A pneumatic tire in which the ply cords which extend to the beads are laid substantially at 90 degrees to the centerline of the tread.

**Retread:** A worn tire casing to which tread rubber has been affixed to extend the usable life of the tire; also known as *re-capped* or *retreaded tire*.

**Siped:** A tire which has been scored or cut perpendicular to the direction of rotation (across the tread) to improve traction.

**Snow:** A tire with an obvious aggressive or lug type tread across the entire width which is designed to be self-cleaning.

**Studded:** A tire to which metal protrusions have been added to improve traction.

**Tire cords:** The strands forming the reinforcement structure in a tire.

**To-and-from school:** Transportation from home to school and from school to home; also transportation from school to school or from school to job training site.

**Tour:** Transportation of a group on a longer trip, usually by *charter bus* (e.g. senior class trip to Washington).

**Tow devices:** Attachments on the chassis frame for use in retrieving a stuck vehicle and/or for towing the vehicle backwards or forwards; also known as *tow eyes*, *tow hooks* or *towing attachment points*.

**Track seating:** A seating system in which seating units, including mobility aids, are secured to the vehicle structure by attaching them to tracks on the vehicle floor.

**Traffic lights:** Traffic signals which control the flow of traffic at intersections.

**Transverse:** Perpendicular to the longitudinal centerline of the vehicle (i.e. from side to side).

**Trip:** The transportation of students from school to any destination, followed by a return trip back to school. The two together make a *round trip*.

**Trippler service:** Regularly scheduled mass transit service which is open to the public, and which is designed or modified to accommodate the needs of school students and personnel, using various fare collections or subsidy systems. Must be part of the regular route service as indicated in published route schedules.

**TSA:** Transportation Security Administration, an agency of the Department of Homeland Security.

**Turbocharger:** a device which uses the pressure of exhaust gases to drive a turbine that, in turn, pressurizes air normally drawn into the engine's chambers.

**Turnkey:** Partial privatization in which a school district hires a company to supply drivers, maintenance management and/or vehicles; also known as *management contract*.

**Two-way radio:** Electronic communication system which uses a designated airway for transmission between a bus and a base station.

**UCRA:** Universal child restraint anchorage—a standardized means of installing child restraint systems in vehicles that is independent of the seat belt system and does not include an upper tether anchorage. UCRA's have been required in all new motor vehicles under 10,000 pounds, including school buses, since September 2002.

**ULSD:** Ultra-low sulfur diesel. Diesel fuel that has a sulfur content of not more than 15 ppm (parts per million). Regular diesel fuel has a sulfur content of 200 ppm.

**UMTA:** Urban Mass Transit Administration, predecessor to FTA.

**Unload:** To discharge passengers from a school bus.

**Unloaded vehicle weight:** The weight of a vehicle with maximum capacity of all fluids necessary for operation, but without cargo or occupants or accessories that are ordinarily removed from the vehicle when they are not in use.

**Universal precautions:** Method of infection control designed to protect the individual from exposure to disease, which requires that all bodily fluids and secretions are treated as though they were infectious.

**UST:** Underground storage tank.

**Vapor lock:** Boiling or vaporization of fuel in the lines from excessive heat, which interferes with liquid fuel movement and in some cases stops the flow.

**Vehicle miles:** The aggregate number of miles a vehicle travels in a given period.

**Video system:** A means of monitoring student behavior in a school bus. The system includes one or more video cameras to tape activity. Camera housing units mounted in each bus appear to hold a camera, whether or not one is actually in place; also known as *surveillance*.

**VIN:** Vehicle Identification Number; a series of Arabic numbers and Roman letters which is assigned to a motor vehicle for identification purposes.

**Viscosity:** A measure of internal resistance to flow or motion offered by a fluid lubricant.

**Walking distance:** The maximum distance a student can be required to walk to school before transportation must be provided; also known as *Non-transportation zone*.

**Weather emergencies:** Weather conditions that require a deviation from normal transportation procedures (e.g., flooding, snowstorm).

**Weight distribution:** The distribution proportion of the vehicle load divided between the front and rear axles.

**Wheel:** A rotating load-carrying member between the tire and the hub, usually consisting of two major parts, the rim and the wheel disc, which may be integral, permanently attached or detachable.

**Ball seat nut mounting:** A wheel mounting system wherein the wheel centering is provided by the wheel mounting studs and the ball seat nuts which, when properly tightened, assure the centering alignment of the wheel.

**Disc:** The part of the wheel which is the supporting member between the hub and the rim.

**Disc wheel:** A permanent combination of a rim and wheel disc.

**Hub:** The rotating outer member of the axle assembly which provides for wheel disc mounting.

**Locking ring:** A removable, split rim ring that holds the rim flange in place on a multi-piece rim.

**Piloted hub mounting:** A wheel mounting system wherein the wheel centering is provided by a close fit between the wheel disc and the hub.

**Rim:** The part of the wheel on which the tire is mounted and supported.

**Spoke wheel:** A rotating member which provides for mounting and support of one or two demountable rims; also known as *wheel for demountable rim*.

**Wheelbase:** The distance between the centerline of the front axle and the centerline of the rear axle.

**Wheelchair:** A seating system comprising at least a frame, seat and wheels for the support and mobility of a person with physical disabilities; also known as *mobile seating device*.

**Wheelchair lift:** (See power lift.)

**ZEB:** Zero-emissions bus.

**ZEV:** Zero-emissions vehicle.

**APPENDIX B**  
**School Bus**  
**Chassis and Body**





## APPENDIX B

### School Bus Chassis And Body

#### National School Bus Yellow Standard

The color known as National School Bus Yellow (NSBY) is specified and described in the School Bus Manufacturers Technical Council publication SBMTC-008, *National School Bus Yellow Color Standard*.

Note: Information concerning the purchase of this standard may be obtained from the Executive Director of the National Association of State Directors of Pupil Transportation Services (NASDPTS) at [www.nasdpts.org](http://www.nasdpts.org).

#### Bus Body Heating System Test

##### 1. Scope

This procedure, limited to liquid coolant systems, establishes uniform cold weather bus vehicle heating system test procedures for all vehicles designed to transport ten (10) or more passengers. Required test equipment, facilities and definitions are included. Defrosting and defogging procedures and requirements are established by SAE J381, *Windshield Defrosting Systems Test Procedure and Performance Requirements—Trucks, Buses, and Multipurpose Vehicles*, and SAE J382, *Windshield Defrosting Systems Performance Guidelines—Trucks, Buses, and Multi-Purpose Vehicles*, which are hereby included by reference.

##### 1.1 Purpose

This procedure is designed to provide bus manufacturers with a cost-effective, standardized test method to provide relative approximations of cold weather interior temperatures.

##### 2. Definitions

**2.1 Heat Exchanger System** - Means will exist for providing heating and windshield defrosting, and defogging, capability in a bus. The system shall consist of an integral assembly, or assemblies, having a core assembly or assemblies, blower(s), fan(s), and necessary duct systems and controls to provide heating, defrosting and defogging functions. If the bus body structure makes up some portion of the duct system, this structure or a simulation of this structure must be included as part of the system.

**2.2 Heat Exchanger Core Assembly** - The core shall consist of a liquid-to-air heat transfer surface(s), liquid inlet and discharge tubes or pipes.

- 2.3 Heat Exchanger-Defroster Blower** - An air moving device(s) compatible with energies available on the bus body.
- 2.4 Coolant** - A 50-50 solution of commercially available glycol antifreeze and commercial purity water. Commercial purity water is defined as “that obtained from a municipal water supply system.”
- 2.5 Heat Exchanger-Defroster Duct System** - Passages that conduct inlet and discharge air throughout the heater system. The discharge outlet louvers shall be included as part of the system.
- 2.6 Heater Test Vehicle** - The completed bus as designed by the manufacturer with or without a chassis, engine and driver train, including the defined heat exchanger system. If the vehicle is without a chassis, it shall be placed on the test site in such a way that the finished floor of the body is at a height, from the test site floor, equal to its installed height when on a chassis, and all holes and other openings normally filled when installed on a chassis will be plugged.
- 2.7 Heat Transfer** - The transfer of heat from liquid to air is directly proportional to the difference between the temperatures of the liquid and air entering the transfer system, for a given rate of liquid and air flow measured in pounds per minute, and that heat removed from liquid is equal to heat given to air.

### **3. Equipment**

- 3.1 Test Site** - A suitable location capable of maintaining an average ambient temperature not to exceed 25°F (-3.9°C) for the duration of the test period. The maximum air velocity across the vehicle shall be 5 mph (8 kph).
- 3.2 Coolant Supply** - A closed loop system, independent of any engine/drive train system, capable of delivering a 50-50 (by volume) solution of antifreeze-water, as defined in 2.4, at 150°±5° (65.5°±1.7°C) above the test site ambient temperature, and 50 lbs (22.7 kg) per minute flow. The coolant supply device shall be equipped with an outlet diverter valve to circulate coolant within the device during its warm-up period. The valve will then permit switching the coolant supply to the bus heat exchanger system at the start of the test.
- 3.3 Power Equipment Supply** - A source capable of providing the required test voltage and current for the heater system.
- 3.4 Heat Exchange Units** - The heat exchangers used shall be labeled as specified by the School Bus Manufacturers Technical Council Standard No. 001, *Procedure for Testing and Rating Automotive Bus Hot Water and Heating and Ventilating Equipment* (Revised 4/94). The test rating of each unit, and quantity used, shall be recorded.

## 4. Instrumentation

### 4.1 Air Temperature

**4.1.1 Interior** - Recommended air temperature measuring instrumentation are thermocouples or resistance temperature detectors (RTDs). Thermometers are not recommended because of their slow response to rapid temperature changes. Measuring instrumentation shall be placed on alternate seat rows beginning  $39\pm 5$  inches ( $99\pm 13$  cm) from the rear of the body, at  $36\pm 2$  inches ( $91\pm 5$  cm) from the finished floor of the body, and on the longitudinal centerline of the body.

**4.1.2 Ambient** - A set of four electrically averaged temperature measuring devices shall be placed  $18\pm 5$  inches ( $46\pm 13$  cm) from the nearest body surface,  $96\pm 5$  inches ( $243\pm 13$  cm) above the floor of test site. One measuring device shall be placed at each of the following locations:

- 1) Midline of body forward of windshield;
- 2) Midline of body aft of the rear surface; and
- 3) Midway between the axles on the right and left sides of the body.

**4.1.3 Driver** - Measuring devices shall be placed at appropriate locations to measure ankle, knee, and breath level temperatures with the driver's seat in rearmost, lowest and body center-most position.

(1) Ankle Level - Place a minimum of four electrically averaged temperature measuring devices at the corners of a 10x10 inches (25x25cm) square area, the rearmost edge of which begins 8 inches (20 cm) forward of the front edge of, and centered on, the seat cushion. The devices shall be located  $3\pm 0.5$  inches ( $7.5\pm 1.3$  cm) above floor surface.

(2) Knee Level - Place a minimum of one measuring device at the height of the front top edge of the seat cushion and on the centerline of the seat. This measurement shall be  $4\pm 1$  inches ( $10\pm 2.5$  cm) forward of the extreme front edge of the seat cushion and parallel to the floor.

(3) Breath Level - Place a minimum of one measuring device  $42\pm 2$  inches ( $107\pm 5$  cm) above the floor and  $10\pm 2$  inches ( $25\pm 5$  cm) forward of the seat back. The forward dimension shall be measured from the upper edge of the seat back and parallel to the floor.

**4.1.4 (Optional) Heat Exchanger Inlet and Outlet Temperature** - A minimum of four electrically averaged temperature measuring devices shall be used to measure the inlet air temperature of each heat exchange unit. Additionally, a minimum of four electronically averaged temperature measuring devices shall be used to measure the outlet air temperature of each heat exchange unit. These sensors shall be placed no closer than 2.0 inches (5.1 cm) from the face of any heater core, to prevent any incidence of radiant heat transfer. Outlet sensors shall be distributed throughout the outlet air stream(s)  $1.0\pm 0.25$  inches ( $2.5\pm 0.6$  cm) from the outlet aperture(s) of the unit heater.

**4.1.5 (Optional) Defrost Air Temperature** - The temperature of the defrost air shall be measured at a point in the defroster outlet(s) that is in the main air flow and which is at least 1.0 inch (2.54 cm) below (upstream of) the plane of the defroster outlet opening. At least one temperature measurement shall be made in each outlet unit. The interior surface temperature(s) of the windshield shall be measured at a point located on the vertical and horizontal centerline(s) of the windshield.

**4.1.6 (Optional) Entrance Area Temperature** - The temperature of the vehicle entrance area shall be measured by two sets of three each electrically averaged temperature measuring devices. One set of three devices shall be placed 1.0 inch (2.54 cm) above the lowest tread of the entrance step, equally spaced on the longitudinal centerline of the tread. The second set of devices shall be placed on the next horizontal surface above the lowest entrance step, 4.0 inches (10.2 cm) from the outboard edge of that surface, spaced identically to the first set of sensors, and placed parallel with the outboard edge of the surface being measured.

**4.2 Coolant Temperature** - The temperature entering and leaving the heat exchanger/defroster system shall be measured as close to the entrance and exit points of the bus body as possible with an immersion thermocouple or RTD device which can be read within  $\pm 0.5^\circ\text{F}$  ( $\pm 0.3^\circ\text{C}$ ).

**4.3 Coolant Flow** - The quantity of coolant flowing shall be measured by means of a calibrated flow meter or weighing tank to an accuracy of at least 2% of setpoint.

**4.4 Coolant Pressure** - The coolant differential pressure shall be measured by suitable connection as close as possible to the inlet and outlet of the heat exchanger/defrosting system. Pressure may be read as inlet and outlet pressure and the differential calculated, or read directly as PSID. Pressure readings shall be made with the use of gauges, manometers or transducers capable of reading within  $\pm 0.1$  psi (689.5 Pa), accurate to  $\pm 0.5\%$  of full scale.

**4.5 Additional Instrumentation** - Additional instrumentation required for vehicle heat exchanger system testing is a voltmeter and a shunt-type ammeter to read the voltage and current of the complete system. The ammeter and voltmeter shall be capable of an accuracy of  $\pm 1\%$  of the reading.

**5. Test Procedures** - Install the heater test vehicle on the test site. Testing shall be conducted in such a way as to prevent the effects of solar heating. At an outdoor test site, testing shall commence and data shall be recorded during the hours following sunset and prior to sunrise, regardless of cloud cover or facility roof. Instrumentation is required to obtain the following readings:

- (a) Vehicle interior (4.1.1)
- (b) Inlet coolant temperature, at entrance to the bus body (4.2)
- (c) Discharge coolant temperature, at exit from the bus body (4.2)

- (d) Voltage and current at main bus bar connection of driver's control panel.
- (e) Ambient temperature (4.1.2)
- (f) Rate of coolant flow (4.3)
- (g) Coolant flow pressure (4.4)
- (h) Elapsed time (stop watch)
- (i) Driver's station temperatures (4.1.3)
- (j) (Optional) Heat Exchanger Inlet and Outlet Temperatures (4.1.4)
- (k) (Optional) Defrost Air Temperature (4.1.5)
- (l) (Optional) Entrance Area Temperature (4.1.6)

Soak the test vehicle, with doors open, for the length of time necessary to stabilize the interior temperature for a 30 minute period as recorded by the vehicle interior temperature measuring devices, and the coolant temperature as measured by the inlet and outlet coolant temperature measuring devices, at the test site temperature,  $\pm 5^{\circ}\text{F}$  ( $\pm 2.5^{\circ}\text{C}$ ), not to exceed  $25^{\circ}\text{F}$  ( $-3.9^{\circ}\text{C}$ ). Warm up the coolant device to the test temperature immediately prior to the start of the test. Use the coolant supply outlet diverter valve to prevent heated coolant from entering the bus heating system prior to the start of the test. At this time, set the heater controls and all fan controls at maximum, close all doors. A maximum of two windows may be left open a total of 1.0 inch (2.5 cm) each. A maximum of two occupants may be in the body during the test period. Record all instrumentation readings at five minute intervals for a period of 1 hour. Recording time shall begin with the initial introduction of heated coolant from the independent coolant supply. The electrical system shall be operated at a maximum of 115% of nominal system voltage  $\pm 0.2$  volts, for example: 13.8 VDC  $\pm 0.2$  volts for a 12 volt (DC) system, and the heat exchanger system shall be wired with the normal vehicle wiring.

*Optional* - Additional flow rates and/or coolant temperatures may also be used to generate supplementary data. Procedure shall be repeated (See 5. Test Procedure.) for each additional flow rate and/or coolant temperature.

## 6. Computations

**6.1 Chart and Computations** - Customary Units-Data shall be recorded on Chart 6.1, or equivalent. Temperature data shall be recorded at the actual temperatures occurring at the time of testing. Air temperature data shall then be adjusted to a  $0^{\circ}\text{F}$  base prior to the construction of graphs. This data reduction shall be directly proportional to the difference between the actual ambient temperature, at the time of test, and  $0^{\circ}\text{F}$  (i.e., actual ambient of  $18^{\circ}\text{F}$  shall result in a reduction of all air temperatures by  $18^{\circ}\text{F}$  and actual ambient temperature of  $-8^{\circ}\text{F}$  shall result in an increase of all air temperatures by  $8^{\circ}\text{F}$ ). Temperature data shall be presented in graph form as well as tabular form. One graph shall be constructed for the body interior air temperatures (4.1.1) wherein the recording intervals shall be the X-axis and the  $^{\circ}\text{F}$  the Y-axis. A separate graph shall be constructed for the driver's temperatures (4.1.3) using the same units for the axes. Optional temperature data (4.1.4, 4.1.5, 4.1.6) may be similarly graphed separate from the interior data.

### 6.1.1 Optional Computations BTU/Hr. Coolant

Heat Transfer:  $Q_w = C_p W_w (T_{in} - T_{out}) \times 60$  where:

1.  $W_w$  = Flow of Coolant (lb/min) — *measured to  $\pm 2$  percent.*
2.  $T_{in}$  = Temperature of Coolant into System ( $^{\circ}$ F) — *measured quantity.*
3.  $T_{out}$  = Temperature of Coolant out of System ( $^{\circ}$ F) — *measured quantity.*
4.  $Q_w$  = Heat removed From Coolant (Btu/hr) — *calculated quantity.*
5.  $C_p$  = Specific Heat of Coolant = 0.8515 (BTU/lb/ $^{\circ}$ F)— *given quantity.*

**6.2 Chart and Computations - Metric Units -** Data shall be recorded on Chart 6.2, or equivalent. Temperature data shall be recorded at the actual temperatures occurring at the time of testing. Air temperature data shall then be adjusted to a  $-18^{\circ}$ C base prior to the construction of graphs. This data reduction shall be directly proportional to the difference between the actual ambient temperature, at the time of test, and  $-18^{\circ}$ C (i.e., actual ambient of  $-7.8^{\circ}$ C shall result in a reduction of all air temperatures by  $10.2^{\circ}$ C and actual ambient temperature of  $-22.2^{\circ}$ C shall result in an increase of all air temperatures by  $4.2^{\circ}$ C). Temperature data shall be presented in graph form as well as tabular form. One graph shall be constructed for the body interior air temperatures (4.1.1) wherein the recording intervals shall be the X-axis and  $^{\circ}$ C the Y-axis. A separate graph shall be constructed for the driver's temperatures (4.1.3) using the same units for the axes. Optional temperature data (4.1.4, 4.1.5, 4.1.6) may be similarly graphed separate from the interior data.

### 6.2.1 Optional Computations BTU/Hr – Coolant

Heat Transfer:  $Q_w = C_p W_w (T_{in} - T_{out}) \times 60$  where:

1.  $W_w$  = Flow of Coolant (kg/min) — *measured to  $\pm 2$  percent.*
2.  $T_{in}$  = Temperature of Coolant into System ( $^{\circ}$ C) — *measured quantity.*
3.  $T_{out}$  = Temperature of Coolant out of System ( $^{\circ}$ C) — *measured quantity.*
4.  $Q_w$  = Heat removed From Coolant (Joules/hr) — *calculated quantity.*
5.  $C_p$  = Specific Heat of Coolant = 3559 (joule/kg/ $^{\circ}$ C) — *given quantity.*



**Chart 6.1-Optional Measurements**

Readings/Calculations	0	5	10	15	20	25	30	35	40	45	50	55	60
T11-Windshield CL Left- °F													
T12-Windshield CL Right- °F													
T13-Defrost Outlet Left- °F													
T14-Defrost Outlet Right °F													
T15-Heater-Inlet °F													
T15-Heater-Outlet °F													
T16-Heater-Inlet °F													
T16-Heater-Outlet °F													
T17-Heater-Inlet °F													
T17-Heater-Outlet °F													
T18-Heater-Inlet °F													
T18-Heater-Outlet °F													
T19-1st Entrance Step													
T20-2nd Entrance Step													
Heat Transfer-BTU/Hr-coolant													

COMPUTATIONAL CHART 6.1-Optional (Fahrenheit)

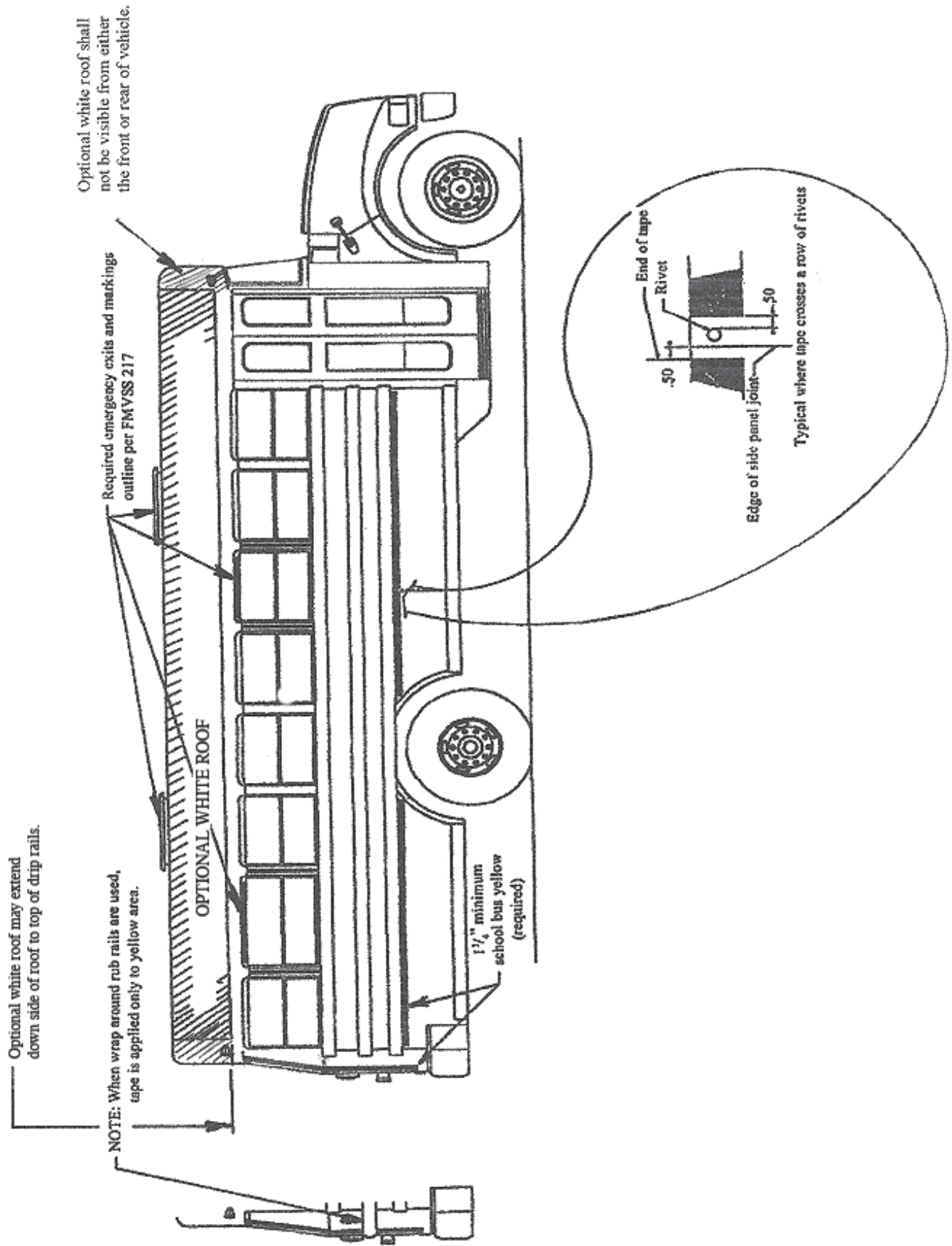



**Chart 6.2-Optional Measurements**

Readings/Calculations	0	5	10	15	20	25	30	35	40	45	50	55	60
T11-Windshield CL Left- °C													
T12-Windshield CL Right- °C													
T13-Defrost Outlet Left- °C													
T14-Defrost Outlet Right °C													
T15-Heater-Inlet °C													
T15-Heater-Outlet °C													
T16-Heater-Inlet °C													
T16-Heater-Outlet °C													
T17-Heater-Inlet °C													
T17-Heater-Outlet °C													
T18-Heater-Inlet °C													
T18-Heater-Outlet °C													
T19-1st Entrance Step													
T20-2nd Entrance Step													
Heat Transfer-J/Hr-coolant													

COMPUTATIONAL CHART 6.2-Optional (Celsius)



PLACEMENT OF RETROREFLECTIVE MARKINGS AND WHITE ROOF

PERIMETER MARKINGS PER NATIONAL SPECIFICATIONS

REQUIRED EMERGENCY EXIT

PERIMETER MARKINGS PER FMVSS 217

PLACEMENT OF RETROREFLECTIVE MARKINGS

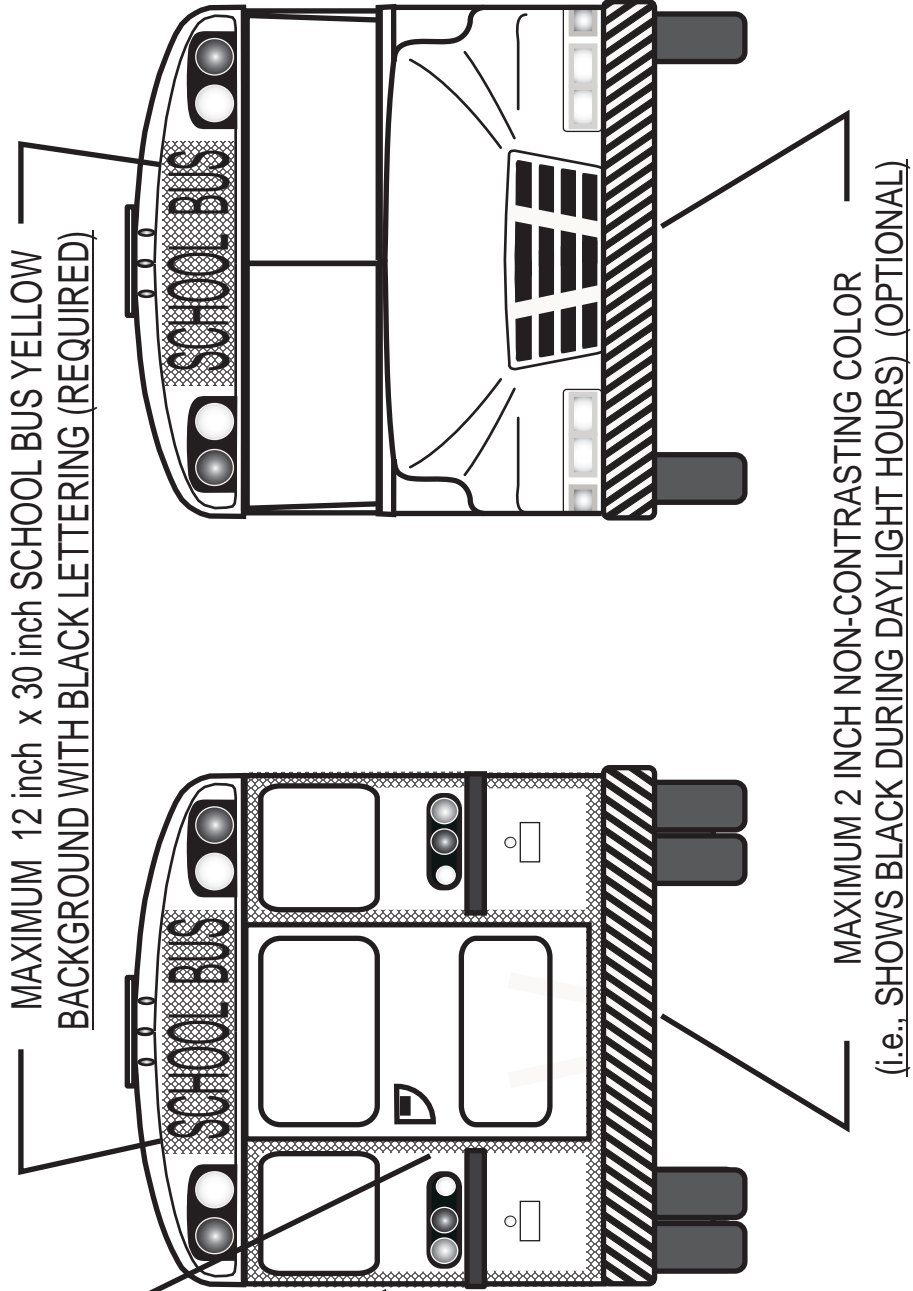

## NOISE TEST PROCEDURE

- A. The vehicle is located so that no other vehicle or signboard, building, hill or other large reflecting surface is within 15.2 m (50 feet) of the occupant's seating position.
- B. All vehicle doors, windows and ventilators are closed.
- C. All power-operated accessories are turned off.
- D. The driver is in the normal seated driving position and the person conducting the test is the only other person in the vehicle.
- E. A sound level meter is used that is set at the "A-weighting fast" meter response and meets the requirements of:
  - 1. The American National Standards Institute, Standard ANSI S1.4-1971: *Specifications for Sound Level Meters*, for Type 1 Meters; or
  - 2. The International Electrotechnical Commission (IEC), Publication No. 179 (1973): *Precision Sound Level Meters*.
- F. The microphone is located so that it points vertically upward 6 inches to the right and directly in line with, and on the same plane as, the occupant's ear, adjacent to the primary noise source.
- G. If the motor vehicle's engine radiator fan drive is equipped with a clutch or similar device that automatically either reduces the rotational speed of the fan or completely disengages the fan from its power source in response to reduced engine cooling loads, the vehicle may be parked before testing with its engine running at high idle or any other speed the operator chooses for sufficient time, but not more than 10 minutes, to permit the engine radiator fan to automatically disengage.
- H. With the vehicle's transmission in neutral gear, the engine is accelerated to:
  - 1. Its maximum governed speed, if it is equipped with an engine governor; or
  - 2. Its speed at its maximum rated horsepower, if it is not equipped with an engine governor, and the engine is stabilized at that speed.
- I. The A-weighted sound level reading on the sound level meter for the stabilized engine speed condition referred to in H.1. or H.2., above, is observed and, if it has not been influenced by extraneous noise sources, is recorded.
- J. The vehicle's engine speed is returned to idle and the procedures set out in paragraphs H. and I. are repeated until 2 maximum sound levels within 2 dBA of each other are recorded. The 2 maximum sound level readings are then averaged; and
- K. The average obtained in accordance with paragraph J., with a value of 2 dBA subtracted therefrom to allow for variations in the test conditions and in the capabilities of meters, is the vehicle's interior sound level at the driver's seating position for the purposes of determining compliance with the requirements of this test procedure.

**Retroreflective Sheeting  
Daytime Color Specification**

The daytime color of the RETROREFLECTIVE sheeting used to enhance school bus safety requires different color tolerances in order to assure optimum safety benefit, as well as to be consistent with the color of the school bus. The color of the RETROREFLECTIVE sheeting shall conform to the table below when samples applied to aluminum test panels are measured as specified in ASTM E1164. For colorimetric measurements, material is illuminated by Standard Illuminant D65 at an angle of 45 degrees with the normal to the surface the observations are made in the direction of the normal (45/0 degree geometry). The inverse (0/45 degree geometry) with the illuminant at the normal to the surface and the observations at 45 degrees with the normal to the surface may also be used. For materials which are directionally sensitive (e.g., prismatic sheeting), the colorimetric measurements are made using circumferential illumination and viewing and the various measurements are averaged. Calculations shall be done in accordance with ASTM E308 using the CIE 1931 (2 degree) Standard Observer.

**Retroreflective Sheeting Daytime Color**

Chromaticity Coordinates of Corner Points  
Determining the Permitted Color Area

		1	2	3	4
Yellow	X	0.484	0.513	0.517	0.544
	Y	0.455	0.426	0.482	0.455
Luminance Factor (Y%)		Minimum		10.0	
		Maximum		36.0	

**School Bus Seat Upholstery Fire Block Test**

**A. Test Chamber**

**Cross Section**

The suggested test chamber is the same cross section as the bus body in which seats are used with the rear section on each end. If a bus section is not used, the cross section is to be 91±1 inch in width x 75 inches ±3 inches in height. There shall be a door, which does not provide ventilation, in the center of each end of the test chamber. The doors shall be 38±3 inches in width and 53±3 inches in height and include a latch to keep the doors closed during the test. (See Figure 1.)

**Length**

The length of the test chamber shall allow three rows of seats at the minimum spacing recommended by the installer. (See Figure 1, Detail A.)

In order that different types of seats may be tested in the same chamber, a length tolerance of plus 45 inches is allowed.

**Ventilation**

One ventilation opening shall be in each end of the test chamber and shall be 325 square inches ±25 square inches. The bottom of the opening shall be 30 inches ±3 inches above the chamber floor. Ventilation openings shall be on the same side of the test chamber. (See Figure 1.)

There shall be no ventilation openings along the length of the test chamber.

A forced-air ventilation system may not be used.

Baffles shall be used to prevent wind from blowing directly into the ventilation openings.

## Camera View Area

An opening covered with glass shall be provided at the midpoint of the test chamber length for camera viewing. The opening shall allow the camera to view the seat parallel to the seat width. (See Figure 1.)

### B. Test Sample

The sample shall be a fully-assembled seat.

Record the weight of all padding and upholstery prior to assembly. Record the weight of the fully-assembled seat.

### C. Ignition Source

A paper grocery bag with dimensions of approximately 7x11x18 inches is used to contain double sheets of newsprint (black print only, approximately 22x28 inches). The total combined weight of bag and newspaper shall be seven ounces  $\pm 0.5$  ounces.

### D. Test Procedure

1. Install three seats in the test chamber at minimum spacing, per installer recommendation. Seats shall be perpendicular to the dimension indicated as "length" in Figure 1. Install so that seat frames will not fall during the test. Seat width shall be determined so that maximum passenger capacity per row (two seats) for the seat style shall be tested.
2. For each test, position the ignition source in the following positions outlined.

Figure 1

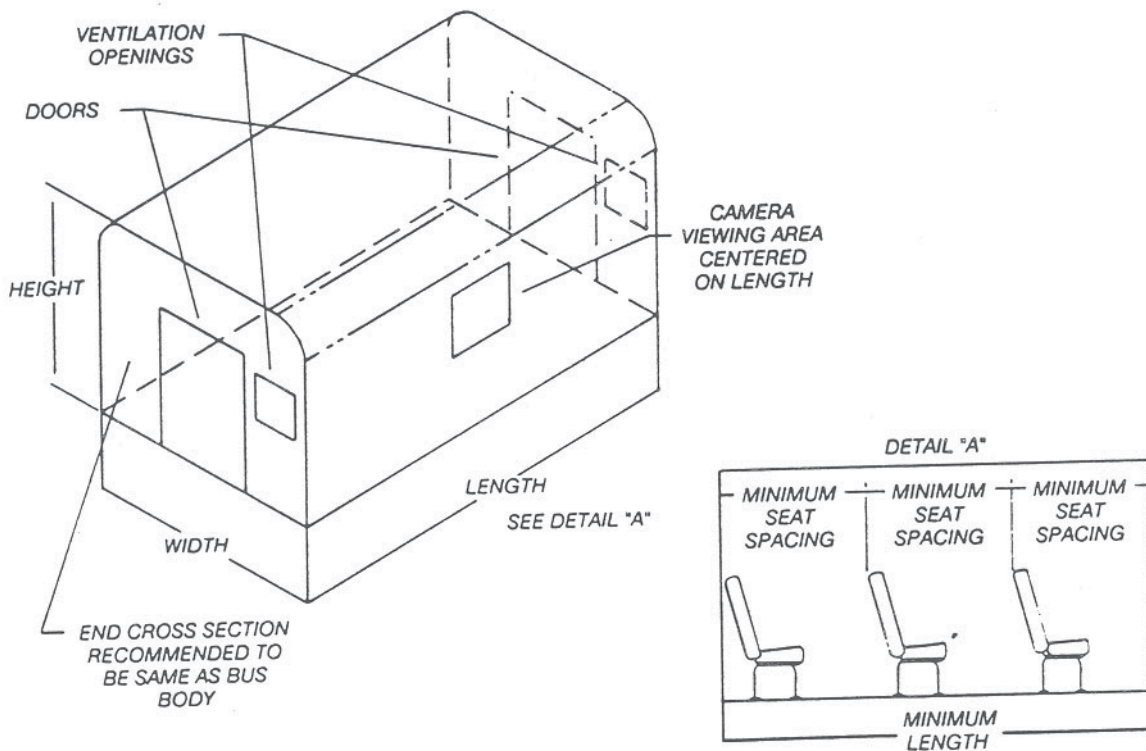

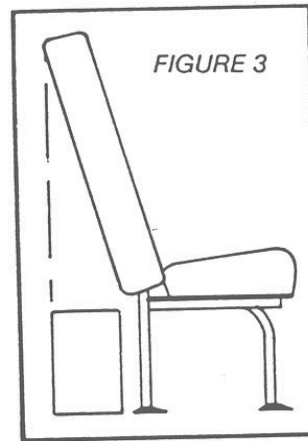
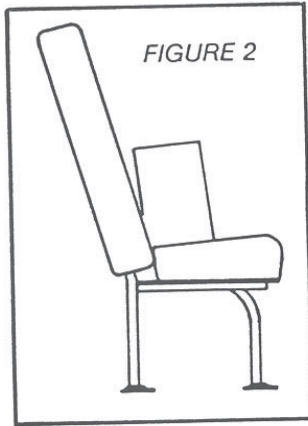

214

**Position A.**

Position ignition source with 18-inch dimension in contact with the seat cushion and touching the seat back. Center the bag on top of the cushion. (See Figure 2.)

**Position B.**

Position the ignition source on the floor behind the seat with 18-inch side resting on floor and parallel to seat width, centered on width so that the rear of bag does not extend beyond the rear seat back. (See Figure 3.)

**Position C.**

Position the ignition source on the floor on the aisle side of the seat with 18-inch dimension on the floor and perpendicular to the seat width touching the seat leg with centerline of the bag at the center of the seat back. (See Figure 4.)

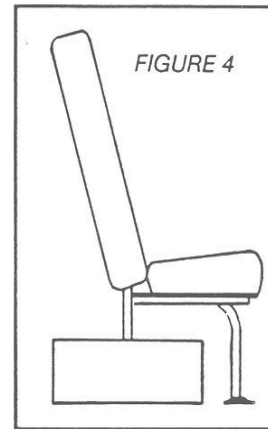

3. A wooden match shall be used to light the ignition source. Time the test, beginning when the ignition source is on fire and ending when all flames are out.
4. After each ignition source position test, weigh seat assembly, including loose material which has fallen off the seat onto the floor.

**E. Performance Criteria**

For each ignition source position test, the seat tested must meet all of the following criteria. A new seat specimen may be used for each ignition source position test.

1. Maximum time from ignition to flameout shall be 8 minutes.
2. Flame shall not spread to any other seat with the ignition source in Position A and Position C.
3. Weight loss may not exceed 10% of the pretest weight of padding and upholstery.



**APPENDIX C**  
**Alternative Fuels**  
**Bibliography**



## APPENDIX C

### BIBLIOGRAPHY

- 49 CFR Part 571, Federal Motor Vehicle Safety Standards. NHTSA (400 Seventh Street SW, Washington, DC 20590).
- A.G.A. Requirements for Natural Gas Vehicle (NGV) Conversion Kits*, No. 1-85. American Gas Association Laboratories, August 20, 1995.
- An Alternative Transportation Fuel*, “The LNG Option.” Roy E. Adkins Cryogenic Fuels, Inc., September 1989.
- An Analysis of the Economic and Environmental Effects of Natural Gas as An Alternative Fuel*, EA 1989-10. December 15, 1989.
- Basic Requirements for Compressed Natural Gas Vehicle (NGV) Fuel Containers*, ANSI/AGA NGV2, American Gas Association Laboratories, 1992.
- “CAA Clean Fuel Fleet Requirements.” Presented by Glenn W. Passavant, U.S. EPA. 1992 SAE Government/Industry Meeting, Washington, D.C., April 30, 1992.
- “Campaigning for NGV’s”: 4th Annual Meeting Proceedings. Dallas, Texas: The Natural Gas Vehicle Coalition, June 24-25, 1992.
- Compressed Natural Gas Conference Proceedings*, SAE P - 129 (compilation of papers). Pittsburgh, Pennsylvania, June 22-23, 1993.
- Compressed Natural Gas (CNG) Demonstration Project: Transit Facility for Buses*. M.S. Consultants, Inc. for the Ohio Department of Transportation, June 1991.
- Compressed Natural Gas (CNG) Vehicular Fuel Systems*, ANSI/NFPA 52 - 1988 Edition. National Fire Protection Association.
- Directory of Natural Gas Vehicle Refueling Stations, Products and Services*, 1991 & 1992 Editions American Gas Association.
- “Extent of Indoor Flammable Plumes Resulting from CNG Bus Fuel System Leaks SAE 922486” by Michael J. Murphy, Susan T. Brown, & David B. Phillips-Battelle, November 1992.
- Florida School Bus Alternate Fuel Manual*. Florida Department of Education (Suite 824, 325 West Gaines Street, Tallahassee, FL 322399-0400), 1992.
- Methanol Use in School Transportation: An Expedition Through the Mind Set of America*, SAE 951966 by Wayne B. Johnston and George Karbowski. Presented to SAE Future Transportation Technology Conference and Exposition, Costa Mesa, CA.
- National Biodiesel Board, compilation of papers, [www.nbb.org](http://www.nbb.org), 1998 – 2005.

*Potential for Compressed Natural Gas Vehicles in Centrally-Fueled Automobile, Truck and Bus Fleet Applications*, by Michael E. Samsa. Gas Research Institute, Strategic Planning and Analysis Division, June 1991.

“Putting the Future of Methanol in Proper Perspective” by J.R. Crocco - Presented to 1992 SAE Government/ Industry Meeting, Washington, DC, April 1992.

Technology Conference Proceedings, The Natural Gas Vehicle Coalition, Dallas, Texas, June 24-25, 1992.

### **Glossary of Alternative Fuels**

**ARB:** The abbreviation for the (California) Air Resources Board, the state agency in California which sets the state’s emission standards.

**BTU:** A unit of work or energy known as a British Thermal Unit. One BTU is the energy required to increase the temperature of one pound of water by one degree Fahrenheit.

**Bi-fuel:** Used to describe a bus capable of running on either of two fuels, although not simultaneously. Engines which can be switched to run on either CNG or gasoline are examples.

**Bio-Diesel:** Is typically produced by a reaction of a vegetable oil or animal fat with an alcohol such as methanol or ethanol. Can be blended with petroleum-based diesel.

**Carbon monoxide:** A product of incomplete combustion; this gas is colorless, odorless and very poisonous. It does not contribute to smog.

**Catalytic converter:** An exhaust after-treatment device containing a catalytic material that is used to burn off or reduce unburned fuel or gases and thus reduce emissions, particularly NO<sub>x</sub> and hydrocarbons. Diesel converters run at cooler temperatures than do gasoline converters and require different catalysts.

**Cetane number:** A measure of self-ignition properties of a fuel after injection in a diesel engine. It relates to the knock properties of fuel. The higher the number, the more easily the fuel will ignite under compression; therefore, higher cetane fuels are usually preferred in diesels engines.

**Combustible gas sensor:** Detector capable of sensing the presence of natural gas.

**Cryogenic:** Relates to storage and use at very low temperatures. LNG requires cryogenic systems.

**Dual-fuel engine:** Also “flex fuel,” used to describe a gasoline-methanol dual-fuel engine using mixtures of gasoline and methanol, such as M85, which is 15 percent gasoline and 85 percent methanol. Dual-fuel engine can also refer to engines operating on any other mixture of fuels simultaneously, such as engines which run on a mixture of CNG and diesel.

**FMVSS:** Federal Motor Vehicle Safety Standard.

**Formaldehyde:** A chemical compound that is a by-product of combustion from engines. Concentrations may be particularly high in emissions from engines fueled by methanol.

**Fumigate:** Literally means “to form a gas or disperse one gas in another.” The term is used to describe the injecting of gas, usually CNG, into the intake air of the engine.

**G/bhp-hr:** The amount of a pollutant generated in one hour measured in grams per brake horsepower.

**GVWR:** Gross Vehicle Weight Rating means the value specified by the manufacturer as the loaded weight in pounds of a single vehicle, which shall not be less than the sum of the unloaded vehicle weight, plus the rated cargo load. For school buses, the rated cargo load is 120 pounds times the vehicle’s designated seating capacity, plus 150 pounds for the driver.

**Greenhouse gases:** Some of these gases are formed by vehicle emissions causing a rise in temperature of the earth’s atmosphere.

**Hybrid vehicle:** Generally refers to a vehicle designed to run on electric power and an internal combustion engine.

**Hydrogen fuel cell:** A chemical reaction process to develop electrical current from oxygen and hydrogen.

**Hydrocarbons:** A gaseous compound formed by incomplete combustion and comprised of unburned and partially burned fuel. It combines with NO<sub>x</sub> and sunlight to form ozone and is a major contributor to smog.

**Lean burn:** Uses more air than is needed for theoretical complete combustion. This added air allows combustion to take place at a lower temperature, thus reducing the emission of NO<sub>x</sub> and CO.

**Nebula combustion chamber:** A unique high-turbulence combustion chamber in the top of a piston, which is particularly effective in efficient burning of lean gas-air mixtures.

**NFPA:** National Fire Protection Association

**NO<sub>x</sub>:** Abbreviation for nitrogen oxides, the gaseous compounds which combine with hydrocarbons and sun light to form ozone, an air pollutant that contributes to smog.

**Octane number:** A measure of anti-knock properties of a fuel that relates to spark ignition engines. The higher the number, the more resistant to knocking. Higher output and more efficient engine designs can be used with higher octane fuel.

**Ozone:** A pollutant formed from nitrogen oxides (NO<sub>x</sub>), hydrocarbons and sunlight. This gas has an irritating odor, is poisonous and is used as an oxidizing agent for bleaching.

**Particulate traps:** An exhaust treatment device used to collect (trap) and periodically burn off particulates and other potential problem emission gases formed in engine exhaust.

**Particulates:** Small solid particles (soot, etc.) formed by engine combustion. Visible particulates are seen in smoke; however, invisible particles may be present in smokeless exhaust.

**Pilot ignition engine:** An engine using a small quantity of diesel fuel to provide an ignition source for an alternative fuel that will not ignite on its own in a compression cycle.

**Port injection:** Similar to the throttle body system except that the fuel is injected near each cylinder intake port. The injectors and their controls can be individually controlled for maximum performance and emissions control.

**Reformulated gasoline:** Also known as “oxygenated gasoline,” reformulated gasoline has oxygen added to improve combustion and reduce emissions.

**Repower installation:** A dedicated natural gas or other engine which was not part of the original chassis at the time of manufacturing.

**Stoichiometric burn:** Use of fuel and air (or oxygen) in the exact ratio needed for complete combustion to generate maximum efficiency and power.

**Throttle body injection:** A gasoline fuel injection system in which the fuel is injected directly into the air intake pipe or manifold. No carburetor is required; electronics monitor engine variables and control the rate of fuel injected.

**UL:** Underwriters Laboratory.

## ALTERNATIVE FUELS COMPARISON CHART

	ENVIRONMENTAL ISSUES		OPERATIONAL ISSUES	
	Pro	Con	Pro	Con
<b>Electric Power</b>	<ul style="list-style-type: none"> <li>• Zero emissions</li> <li>• Electricity often produced from renewable domestic energy resource</li> <li>• Extremely quiet</li> </ul>	<ul style="list-style-type: none"> <li>• Electric power from coal or oil does not eliminate overall emissions</li> <li>• Battery disposal is a concern</li> </ul>	<ul style="list-style-type: none"> <li>• Distribution systems already in place. (Power generation and transmission system)</li> <li>• Extremely quiet</li> <li>• Low operating cost per mile</li> </ul>	<ul style="list-style-type: none"> <li>• Low range due to weight and storage capacity of batteries</li> <li>• Current cost for vehicles extremely high</li> <li>• Overall vehicle weight, limits passenger capacity</li> <li>• Current technology requires battery replacement during life of vehicle</li> </ul>
<b>Hybrid Electric</b>	<ul style="list-style-type: none"> <li>• Used with any internal combustion engine</li> <li>• Reduced emissions over all</li> <li>• Low operating cost per mile</li> </ul>	<ul style="list-style-type: none"> <li>• Still has some emissions</li> <li>• In some areas, emissions are produced generating electricity for plug-in</li> <li>• Battery disposal</li> </ul>	<ul style="list-style-type: none"> <li>• Plug-in type charges overnight</li> <li>• Very quiet in electric mode</li> <li>• Lower operating cost per mile</li> <li>• Reduces foreign oil dependency</li> </ul>	<ul style="list-style-type: none"> <li>• Batteries need to be replaced every 7 years</li> <li>• Availability is limited and therefore expensive</li> </ul>
<b>Clean Diesel</b>	<ul style="list-style-type: none"> <li>• Reduced emissions</li> <li>• Reduces particulate matter 20% - 30% in older engines</li> <li>• Few safety problems</li> </ul>	<ul style="list-style-type: none"> <li>• Needs particulate and NO<sub>x</sub> reduction</li> <li>• Still some smoke (cold and high altitude)</li> <li>• Spill leakage contamination</li> </ul>	<ul style="list-style-type: none"> <li>• Readily available and uses current distribution</li> <li>• Minimal cost increase</li> <li>• Very efficient, good mileage</li> <li>• Useable in older engines</li> </ul>	<ul style="list-style-type: none"> <li>• Hard cold starting</li> <li>• Foreign oil dependency</li> <li>• Not available in all areas</li> </ul>
<b>Bio-Diesel</b>	<ul style="list-style-type: none"> <li>• Significant emissions reduction</li> <li>• Blends with petroleum fuel and will run in current engines reducing emissions</li> </ul>	<ul style="list-style-type: none"> <li>• In some engines NO<sub>x</sub> emissions are higher</li> </ul>	<ul style="list-style-type: none"> <li>• Derived from natural renewable oils</li> <li>• Reduces foreign oil dependency</li> <li>• Dispenses with current systems</li> </ul>	<ul style="list-style-type: none"> <li>• May degrade rubber parts in fuel system</li> <li>• Higher cloud point and pour point, poor cold start-ability</li> <li>• Eight percent less energy</li> <li>• May clog systems at first</li> </ul>
<b>Reformulated Gasoline</b>	<ul style="list-style-type: none"> <li>• Reduced emissions in older engines</li> <li>• Can be used in any gasoline engine</li> </ul>	<ul style="list-style-type: none"> <li>• Still high in smog forming emissions</li> <li>• Spill leakage contamination</li> <li>• Non-renewable resource</li> </ul>	<ul style="list-style-type: none"> <li>• Will be readily available when required by EPA</li> <li>• Minimal cost increase</li> <li>• Usable in older engines</li> </ul>	<ul style="list-style-type: none"> <li>• Over twice the cost per mile vs. diesel</li> <li>• Foreign oil dependency</li> </ul>
<b>Methanol</b>	<ul style="list-style-type: none"> <li>• Low NO<sub>x</sub> particulate</li> <li>• Dissipation in water and bio-degradable</li> <li>• Diverse fuel sources</li> </ul>	<ul style="list-style-type: none"> <li>• Generates formaldehyde</li> <li>• Very toxic</li> </ul>	<ul style="list-style-type: none"> <li>• High octane for efficient spark ignition combustion</li> <li>• Liquid borne easy to distribute</li> <li>• Blends well with gasoline</li> </ul>	<ul style="list-style-type: none"> <li>• Corrosive</li> <li>• Invisible flame</li> <li>• Explosive vapors</li> <li>• Hard cold starting</li> <li>• Limited production</li> <li>• Limited fuel locations</li> <li>• 45% energy of diesel</li> </ul>
<b>Ethanol</b>	<ul style="list-style-type: none"> <li>• Low in NO<sub>x</sub> and particulates</li> <li>• Dissipation in water and bio-degradable</li> <li>• Renewable resource</li> </ul>	<ul style="list-style-type: none"> <li>• Slight smoking</li> <li>• Generates formaldehyde, but less than methanol</li> <li>• Uses about the same energy to produce as it generates</li> </ul>	<ul style="list-style-type: none"> <li>• High octane for efficient spark ignition combustion.</li> <li>• Liquid borne easy to distribute</li> <li>• Blends well with gasoline</li> </ul>	<ul style="list-style-type: none"> <li>• High cost to produce</li> <li>• Limited production capability</li> <li>• Limited fuel locations</li> <li>• 50% of energy of diesel (low range or large fuel tanks)</li> </ul>
<b>Compressed Natural Gas (CNG)</b>	<ul style="list-style-type: none"> <li>• Low emissions</li> <li>• Smokeless</li> <li>• Available from the well, minimum processing</li> </ul>	<ul style="list-style-type: none"> <li>• Needs NO<sub>x</sub> reduction</li> <li>• Requires energy to compress</li> </ul>	<ul style="list-style-type: none"> <li>• Gasoline conversion available</li> <li>• Attractive fuel cost</li> <li>• Ample domestic supply</li> <li>• Low engine maintenance</li> <li>• Minimum explosion hazard</li> <li>• Vapors lighter than air, dissipates quickly</li> </ul>	<ul style="list-style-type: none"> <li>• Slow refueling</li> <li>• Limited vehicle fuel distribution</li> <li>• Fuel quality variation</li> <li>• High pressure on-board fuel storage, heavy and complex</li> <li>• Limited energy and range, relative to diesel.</li> </ul>
<b>Liquid Natural Gas (LNG)</b>	<ul style="list-style-type: none"> <li>• Low emissions</li> <li>• Smokeless</li> <li>• Available from the well, minimum processing</li> </ul>	<ul style="list-style-type: none"> <li>• Needs NO<sub>x</sub> reduction</li> <li>• Requires energy to liquefy and cool</li> </ul>	<ul style="list-style-type: none"> <li>• Basic engine same as CNG</li> <li>• Attractive fuel cost</li> <li>• Ample domestic supply</li> <li>• Less than ½ tank space of CNG</li> <li>• Low engine maintenance</li> <li>• Minimal explosion hazard</li> <li>• Vapors lighter than air</li> </ul>	<ul style="list-style-type: none"> <li>• Slow refueling</li> <li>• Limited availability today</li> <li>• Cryogenic handling (-260F)</li> <li>• Must vent fuel system after 7 to 10 days</li> <li>• High pressure on board fuel storage,</li> <li>• Heavy and complex</li> </ul>
<b>LPG (Propane)</b>	<ul style="list-style-type: none"> <li>• Low emissions</li> <li>• Smokeless</li> </ul>	<ul style="list-style-type: none"> <li>• Needs NO<sub>x</sub> reduction</li> <li>• Requires energy to liquefy</li> </ul>	<ul style="list-style-type: none"> <li>• Fairly wide distribution</li> <li>• Long term experience in vehicle</li> <li>• Good cold starting</li> </ul>	<ul style="list-style-type: none"> <li>• Slow refueling</li> <li>• Limited energy and range, relative to diesel</li> <li>• Vapors heavier than air</li> <li>• Explosion potential</li> </ul>





**APPENDIX D**  
**School Bus**  
**Operations**



## APPENDIX D

### National Highway Traffic Safety Administration Highway Safety Program Guideline #17 PUPIL TRANSPORTATION SAFETY

I. **Scope.** This guideline establishes minimum recommendations for a State Highway Safety Program for pupil transportation safety including the identification, operation and maintenance of buses used for carrying students; training of passengers, pedestrians and bicycle riders; and administration.

II. **Purpose.** The purpose of this guideline is to minimize, to the greatest extent possible, the danger of death or injury to school children while they are traveling to and from school and school-related events.

III. **Definitions.** “Bus” is a motor vehicle designed for carrying more than 10 persons (including the driver).

“Federal Motor Carrier Safety Regulations (FMCSR)” are the regulations of the Federal Motor Carrier Safety Administration (FMCSA) for commercial motor vehicles in interstate commerce, including buses with a gross vehicle weight rating (GVWR) greater than 10,000 pounds or designed to carry 16 or more persons (including the driver), other than buses used to transport school children from home to school and from school to home. (The FMCSR are set forth in 49 CFR Parts 383-399.)

“School-chartered bus” is a “bus” that is operated under a short-term contract with state or school authorities who have acquired the exclusive use of the vehicle at a fixed charge to provide transportation for a group of students to a special school-related event.

“School bus” is a “bus” that is used for purposes that include carrying students to and from school or related events on a regular basis, but does not include a transit bus or a school-chartered bus.

IV. **Pupil Transportation Safety Program Administration and Operations.**

**Recommendation.** Each state, in cooperation with its school districts and other political subdivisions, should have a comprehensive pupil transportation safety program to ensure that school buses and school-chartered buses are operated and maintained so as to achieve the highest possible level of safety.

A. **Administration.**

1. There should be a single state agency having primary administrative responsibility for pupil transportation, and employing at least one full-time professional to carry out these responsibilities.
2. The responsible state agency should develop an operating system for collecting and reporting information needed to improve the safety of operating school buses and school-chartered buses. This includes the collection and evaluation of uniform crash data consistent with the criteria set forth in Highway Safety Program Guidelines No. 10, “Traffic Records” and No. 19, “Accident Investigation and Reporting.”

B. **Identification and Equipment of School Buses.** Each state should establish procedures to meet the following recommendations for identification and equipment of school buses.

1. All school buses should:
  - a. Be identified with the words “School Bus” printed in letters not less than eight inches high, located between the warning signal lamps as high as possible without impairing visibility of the lettering from both front and rear, and have no other lettering on the front or rear of the vehicle, except as required by Federal Motor Vehicle Safety Standards (FMVSS), 49 CFR Part 571.

- b. Be painted National School Bus Yellow, in accordance with the colorimetric specification of National Institute of Standards and Technology (NIST) Federal Standard No. 595a, Color 13432, except that the hood should be either that color or lusterless black, matching NIST Federal Standard No. 595a, Color 37038.
  - c. Have bumpers of glossy black, matching NIST Federal Standard No. 595a, Color 17038, unless, for increased visibility, they are covered with a reflective material.
  - d. Be equipped with safety equipment for use in an emergency, including a charged fire extinguisher, that is properly mounted near the driver's seat, with signs indicating the location of such equipment.
  - e. Be equipped with device(s) demonstrated to enhance the safe operation of school vehicles, such as a stop signal arm.
  - f. Be equipped with a system of signal lamps that conforms to the school bus requirements of FMVSS No. 108, 49 CFR 571.108.
  - g. Have a system of mirrors that conforms to the school bus requirements of FMVSS No. 111, 49 CFR 571.111, and provides the seated driver a view to the rear along both sides of the bus and a view of the front bumper and the area in front of the bus. Mirrors should be positioned and adjusted such that when a rod, 30 inches long, is placed upright on the ground at any point along a traverse line one-foot forward of the forward-most point of a school bus, at least seven 1/2 inches of the length of the rod should be visible to the driver, either by direct view or by the system of mirrors.
  - h. Comply with all FMVSS applicable to school buses at the time of their manufacture.
2. Any school bus meeting the identification recommendations of sections 1. a.-h. above, that is permanently converted for use wholly for purposes other than transporting children to and from school or school-related events, should be painted a color other than National School Bus Yellow, and should have the stop arms and school bus signal lamps described by sections 1. e. & f. removed.
3. School buses, while being operated on a public highway and transporting primarily passengers other than school children, should have the words "School Bus" covered, removed, or otherwise concealed, and the stop arm and signal lamps described by sections 1.e. & f. should not be operated.
4. School-chartered buses should comply with all applicable FMCSR and FMVSS.
- C. **Operations.** Each state should establish procedures to meet the following recommendations for operating school buses and school-chartered buses:
- 1. Personnel.
    - a. Every person who drives a school bus or school-chartered bus occupied by school children should, as a minimum:
      - (1) Have a valid state driver's license to operate such a vehicle. All drivers who operate a vehicle designed to carry 16 or more persons (including the driver) are required by FMCSA's Commercial Driver's License

Standards by April 1, 1992 (49 CFR Part 383) to have a valid commercial driver's license.

- (2) Meet all physical, mental, moral and other requirements established by the state agency having primary responsibility for pupil transportation, including requirements for drug and/or alcohol misuse or abuse; and
- (3) Be qualified as a driver under the Federal Motor Carrier Safety regulations of the FMCSA, 49 CFR Part 391, if the driver or the driver's employer is subject to those regulations.

2. Vehicles.

- a. Each state should enact legislation that provides for uniform procedures regarding school buses stopping on public highways for loading and discharge of children. Public information campaigns should be conducted on a regular basis to ensure that the driving public fully understands the implications of school bus warning signals and requirements to stop for school buses that are loading or discharging school children.
- b. Each state should develop plans for minimizing highway use hazards to school bus and school-chartered bus occupants, other highway users, pedestrians, bicycle riders and property. They should include, but not be limited to:
  - (1) Careful planning and annual review of routes for safety hazards;
  - (2) Planning routes to ensure maximum use of school buses and school-chartered buses, and to ensure that passengers are not standing while these vehicles are in operation;
  - (3) Providing loading and unloading zones off the main traveled part of highways, whenever it is practical to do so;
  - (4) Establishing restricted loading and unloading areas for school buses and school-chartered buses at or near schools;
  - (5) Ensuring that school bus operators, when stopping on a highway to take on or discharge children, adhere to state regulations for loading and discharging including the use of signal lamps as specified in section B. 1. f. of this guideline;
  - (6) Prohibiting, by legislation or regulation, operation of any school bus unless it meets the equipment and identification recommendations of this guideline;
  - (7) Replacing, consistent with the economic realities which typically face school districts, those school buses which are not manufactured to meet the April 1, 1977 FMVSS for school buses, with those manufactured to meet the stricter school bus standards, and not chartering any pre-1977 school buses; and
  - (8) Informing potential buyers of pre-1977 school buses that these buses may not meet current standards for newly manufactured buses and of the need for continued maintenance of these buses and adequate safety instruction.

- c. Use of amber signal lamps to indicate that a school bus is preparing to stop to load or unload children is at the option of the state. Use of red warning signal lamps as specified in section B 1. f. of this guideline for any purpose or at any time other than when the school bus is stopped to load or discharge passengers should be prohibited.
- d. When school buses are equipped with stop arms, such devices should be operated only in conjunction with red warning signal lamps, when vehicles are stopped.
- e. Seating
  - (1) Standing while school buses and school-chartered buses are in motion should not be permitted. Routing and seating plans should be coordinated so as to eliminate passengers standing when a school bus or school-chartered bus is in motion.
  - (2) Seating should be provided that will permit each occupant to sit in a seat intended by the vehicles' manufacturer to provide accommodation for a person at least as large as a 5th percentile adult female, as defined in 49 CFR 571.208. Due to the variation in sizes of children of different ages, states and school districts should exercise judgement in deciding how many students are actually transported in a school bus or school-chartered bus.
  - (3) There should be no auxiliary seating accommodations such as temporary or folding jump seats in school buses.
  - (4) Drivers of school buses and school-chartered buses should be required to wear occupant restraints whenever the vehicle is in motion.
  - (5) Passengers in school buses and school-chartered buses with a gross vehicle weight rating (GVWR) of 10,000 pounds or less should be required to wear occupant restraints (where provided) whenever the vehicle is in motion. Occupant restraints should comply with the requirement of FMVSS Nos. 208, 209 and 210, as they apply to multipurpose vehicles.
- f. Emergency exit access. Baggage and other items transported in the passenger compartment should be stored and secured so that the aisles are kept clear and the door(s) and emergency exit(s) remain unobstructed at all times. When school buses are equipped with interior luggage racks, the racks should be capable of retaining their contents in a crash or sudden driving maneuver.

D. **Vehicle Maintenance.** Each state should establish procedures to meet the following recommendations for maintaining buses used to carry school children:

- 1. School buses should be maintained in safe operating condition through a systematic preventive maintenance program.
- 2. All school buses should be inspected at least semi-annually. In addition, school buses and school-chartered buses subject to the Federal Motor Carrier Safety Regulations of FMCSA should be inspected and maintained in accordance with those regulations (49 CFR Parts 393 and 396).

3. School bus drivers should be required to perform daily pre-trip inspections of their vehicles, and the safety equipment thereon (especially fire extinguishers), and to report promptly and in writing any problems discovered that may affect the safety of the vehicles's operation or result in its technical breakdown. Pre-trip inspection and condition reports for school buses and school-chartered buses subject to the Federal Motor Carrier Safety Regulations of FMCSA should be performed in accordance with those regulations (49 CFR 392.7, 392.8, and 396).

**E. Other Aspects of Student Transportation Safety.**

1. At least once during each school semester, each pupil transported from home to school in a school bus should be instructed in safe riding practices, proper loading and unloading techniques, proper street crossing to and from school bus stops and should participate in supervised emergency evacuation drills, which are timed. Prior to each departure, each pupil transported to an activity or field trip in a school bus or school-chartered bus should be instructed in safe riding practices and on the location and operation of emergency exits.
2. Parents and school officials should work together to select and designate the safety pedestrian and bicycle routes for the use of school children.
3. All school children should be instructed in safe transportation practices for walking to and from school. For those children who routinely walk to school, training should include preselected routes and the importance of adhering to those routes.
4. Children riding bicycles to and from school should receive bicycle safety education, wear bicycle safety helmets, and not deviate from preselected routes.
5. Local school officials and law enforcement personnel should work together to establish crossing guard programs.
6. Local school officials should investigate programs which incorporate the practice of escorting students across streets and highways when they leave school buses. These programs may include the use of school safety patrols or adult attendants.
7. Local school officials should establish passenger vehicle loading and unloading points at schools that are separate from the school bus loading zones.

- F. Program evaluation.** The pupil transportation safety program should be evaluated at least annually by the state agency having primary administrative responsibility for pupil transportation.

**SCHOOL BUS DRIVER APPLICATION  
(Sample Form)**

Applicant Name: \_\_\_\_\_

Present Address: \_\_\_\_\_

Date of Birth: \_\_\_\_\_ Social Security # \_\_\_\_\_

Addresses at which applicant has resided during the past three (3) years: \_\_\_\_\_

\_\_\_\_\_

Current Driver's License Number: \_\_\_\_\_

State of Issue: \_\_\_\_\_ Expiration Date: \_\_\_\_\_

Class of License: \_\_\_\_\_ Endorsements: \_\_\_\_\_ Restrictions: \_\_\_\_\_

Have you had any type of vehicle accident in the last three (3) years?     yes     no

If yes, give dates and explain: \_\_\_\_\_

\_\_\_\_\_

Have you ever been terminated or suspended from previous employment because of a positive drug or alcohol test?

yes     no

Have you been convicted of a moving traffic violation in the last three (3) years?                     yes     no

If yes, give dates and explain: \_\_\_\_\_

\_\_\_\_\_

Has your driver's license been suspended or revoked during the last three (3) years?

yes     no

If yes, give dates and explain: \_\_\_\_\_

\_\_\_\_\_

Has your license ever been revoked, suspended or denied since the time you obtained your original license?

yes     no

If yes, give dates and explain: \_\_\_\_\_

\_\_\_\_\_

Have you held a license in another state during the last three (3) years?                     yes     no

Which state(s): \_\_\_\_\_



List the names and addresses of your current and previous employers during the ten (10) years preceding the date of this application:

Employer: \_\_\_\_\_

Address: \_\_\_\_\_

Dates: \_\_\_\_\_

Reason for leaving: \_\_\_\_\_

Job Title & Duties: \_\_\_\_\_

Employer: \_\_\_\_\_

Address: \_\_\_\_\_

Dates: \_\_\_\_\_

Reason for leaving: \_\_\_\_\_

Job Title & Duties: \_\_\_\_\_

Additional employers may be listed on a separate sheet.

Education and training (circle the highest obtained):

8 9 10 11 12 GED 13 14 15 16 17 18 19+

Degrees earned: \_\_\_\_\_

Specific experience or formal training related to transportation of students: I understand that the information provided by me may be checked, and previous employers may be contacted for the purpose of investigating my background. This certifies that this application was completed by me, and that all entries and information on it are true and complete to the best of my knowledge.

(Date) \_\_\_\_\_ (Signature) \_\_\_\_\_

I authorize the employer to conduct a criminal history check, and to investigate all written information contained on this application.

(Date) \_\_\_\_\_ (Signature) \_\_\_\_\_

**ACTIONS TO BE TAKEN DURING AND  
FOLLOWING THE OBSERVATIONS OF SCHOOL  
BUS ROUTES**

Supervisory actions that should be taken during and after the transportation director completes a review of bus routes are listed below:

1. Check the route and schedule for accuracy.
2. Determine that loading and unloading occurs only at authorized stops.
3. Check to see that vehicles are operated in compliance with prescribed regulations.
4. Observe the driver-student relationship.
5. Check loading and unloading conditions at school centers.
6. Check for evidence of supervision in loading zones.
7. Note hazardous road conditions.
8. Note the nature, frequency and locations of bus stop law violations.
9. Observe conditions of bus (e.g., cleanliness, tires, windows, emergency exit(s), first aid kits, fire extinguisher, seats, etc.).
10. Observe vehicle inspection guide for evidence of pre-trip inspection.
11. Note driver attitude toward other motorists and pedestrians.
12. Follow the observation with a written report and discussion with the driver (and others, as appropriate). The discussion should be used to encourage the driver to become self-auditing and participate in giving supervisors information that is helpful in improving the overall safety, effectiveness and efficiency of the student transportation system.
13. File the written report in the driver's permanent record.

## **GUIDELINES FOR EN ROUTE EMERGENCY BUS EVACUATION PROCEDURES**

The intent of these procedures is to provide guidelines for evacuating a bus only when absolutely necessary in an emergency situation, for the safety of students and staff.

### **I. Preparing an Emergency Evacuation Plan:**

Each bus should have an emergency evacuation plan, which should be kept in the bus. The plan should allow for individual capabilities and needs of each student, the type of behaviors that might be exhibited during an emergency evacuation and the types of wheelchair or support equipment being used for students. A floor plan with student location and special needs should be in the bus. Issues that should be considered when establishing an evacuation plan are listed below.

- A. Whether or not students can help, and to what extent;
- B. How to deal with individual emergencies (e.g., seizures) during the evacuation process;
- C. Whether students should be evacuated in their wheelchairs, or removed from their wheelchairs before evacuation;
- D. How to disconnect or cut wheelchair securement and occupant protection equipment, including belts, trays and other support equipment;
- E. The order or sequence in which students should be evacuated;
- F. The length of time a student requiring life support equipment or medical care procedures can survive if such service is interrupted or delayed during the evacuation process;
- G. Where to gather once off the bus and how to evaluate different scenarios to make the best decision about where to gather;
- H. Training plan and schedules for drivers and students; and
- I. Specific emergency equipment needed, training in use and assignment of responsibility to remove from the bus when evacuations occur.

### **II. Assessing the Need to Evacuate:**

Student safety and control are best maintained by keeping students in the bus during an emergency and/or impending crisis situation if doing so does not expose them to unnecessary risk or injury. A decision to evacuate should include consideration of the following conditions:

- A. Is there a fire involved?
- B. Is fuel leaking?
- C. Might the bus roll or tip, thereby causing further threat to safety?
- D. Is the bus likely to be hit by other vehicles?
- E. Is the bus in the direct path of a sighted tornado or other natural disaster, such as rising water?
- F. Would evacuating students expose them to speeding traffic, severe weather or another dangerous environment?

- G. Considering the medical, physical and emotional condition of the students, does staying in the bus or evacuating pose the greater danger to the students' safety?

**III. General Procedures to Follow for Emergency Evacuation:**

- A. Keep the situation as orderly and low-key as possible.
- B. If time and conditions permit, the bus driver should use the communication system to advise the office of the following information:
  - 1. The exact location, including nearest intersecting road or familiar landmark;
  - 2. The condition creating the emergency;
  - 3. The type of assistance needed (police-fire-ambulance); and
  - 4. Notification that the bus is being evacuated.
- C. Analyze conditions to determine the safest exit from the bus and safest gathering location.
- D. During evacuation, monitor conditions and adjust procedures to meet unexpected circumstances.
- E. Move evacuated students to the nearest safe location at least 100 feet from the bus.
- F. Be prepared to give information to emergency medical personnel regarding individual students' medical or physical requirements.

**IV. Equipment Considerations:**

- A. Bus staff should, as part of their pre-trip inspection, familiarize themselves with the location and method of opening all emergency exits.
- B. If time permits, a lift platform can be lowered half the distance to the ground, providing a step for evacuating wheelchairs. If there is a smell of spilled fuel, the lift should be operated manually.
- C. When re-entry to the bus is not probable, communication equipment and first aid kits can frequently be passed through a window, making them accessible outside the bus. Consideration should also be made for student medication, if carried and needed.
- D. If a large bus is being used and evacuation is made through the rear exit door, consideration should be given to the method to be used for re-entry to the bus, if necessary, considering the height of the floor from the ground. Some states allow a stirrup-type step on the rear bumper.
- E. If a battering ram is needed, a fire extinguisher can often serve that purpose.
- F. A belt cutter shall be stored in the bus in a location readily accessible to the driver when he/she is seated in the normal driving position and location. The cutter should have a protected mouth to restrict the entry of fingers, etc.

**V. Local District Policy:**

Bus staff should be familiar with local district policy regarding the following items:

- A. Evacuation procedures to follow when students are en route; or, what to do if a tornado or flash flood, etc. is sighted and no shelter is near.

- B. The type of medical information to be available on long distance trips in case of student injury.

**Note:** THE SAFETY OF THE BUS AND EQUIPMENT IS SECONDARY TO THE SAFETY OF THE STUDENTS. NO ATTEMPT SHOULD BE MADE TO SAVE EQUIPMENT OR PERSONAL ITEMS UNTIL ALL STUDENTS ARE REMOVED FROM THE BUS SAFELY, ARE OUT OF DANGER AND ARE SUPERVISED.

**Sample Crash Reporting Form  
(School Bus Physically Involved)**

The school bus crash reporting form has been automated on a national level to assist states in developing a uniform web-based format to gather important collision data. This format allows for collection of collision data involving students traveling to and from school and school activities as occupants in school buses and as pedestrians. This web-based format is not intended to suggest how each individual state should collect data; rather, it is designed to allow data to be tabulated, analyzed and compared using consistent criteria.

The establishment of this uniform web-based reporting system allows states to gather information according to reporting criteria established by the individual state mandates, but allows that information to be analyzed nationally by sorting the data by uniform national criteria, resulting in timely responses to national organizations or federal agencies that request the crash data. The adoption of this format will provide a realistic uniform database that could be utilized to enhance the safety and economy of student travel in each state.

1. Type of Crash?

<input type="checkbox"/> Between motor vehicles	<input type="checkbox"/> Fixed object
<input type="checkbox"/> Non-collision pedestrian	<input type="checkbox"/> Pedalcycle
<input type="checkbox"/> Railroad train	
<input type="checkbox"/> Other collision (describe): _____	

2. Complete if Fixed Object Crash.

<input type="checkbox"/> Embankment	<input type="checkbox"/> Sign
<input type="checkbox"/> Utility pole	<input type="checkbox"/> Guardrail
<input type="checkbox"/> Tree	<input type="checkbox"/> Bridge rail
<input type="checkbox"/> Fence	<input type="checkbox"/> Median barrier
<input type="checkbox"/> Fire hydrant	<input type="checkbox"/> Curb or wall
<input type="checkbox"/> Culvert or head wall	<input type="checkbox"/> Parked vehicle
<input type="checkbox"/> Other (describe): _____	

3. Did Crash Result In...

<input type="checkbox"/> Fatality?	<input type="checkbox"/> Non-incapacitating injury(moderate)?
<input type="checkbox"/> Incapacitating injury (serious)?	<input type="checkbox"/> Possible injury (minor)?
<input type="checkbox"/> Property damage only (no one was killed or injured, but property damage equaled or exceeded \$1,000)?	

4. Manner of Collision Between Vehicles or Objects?

<input type="checkbox"/> Angle	<input type="checkbox"/> Rear-end
<input type="checkbox"/> Head-on	<input type="checkbox"/> Broadside
<input type="checkbox"/> Other (describe): _____	

5. Bus Direction Analysis

A. Collision with Pedestrian

**Intersection**

<input type="checkbox"/> Bus going straight
<input type="checkbox"/> Bus turning right
<input type="checkbox"/> Bus turning left
<input type="checkbox"/> Bus backing
<input type="checkbox"/> Other action (describe): _____

**Non-Intersection**

<input type="checkbox"/> Bus going straight
<input type="checkbox"/> Bus turning right
<input type="checkbox"/> Bus turning left
<input type="checkbox"/> Bus backing
<input type="checkbox"/> Other action (describe): _____

B. Collision with other vehicle

**Intersection**

- Entering at angle, both moving
- Entering same direction, both moving
- Entering opposite direction, both moving

**Non-Intersection**

- Same direction, both moving
- Opposite direction, both moving
- One vehicle stopped

C. All Other Collisions (describe): \_\_\_\_\_

**Intersection**

- Fixed object
- Other road vehicle, train, pedalcycle
- Other object, animal (describe): \_\_\_\_\_

**Non-Intersection**

- Fixed object
- Other road vehicle, train, pedalcycle
- Other object, animal (describe): \_\_\_\_\_

D. Non-Collision

**Intersection**

- Overturn
- Other non-collision (describe): \_\_\_\_\_

**Non-Intersection**

- Overturn
- Other non-collision (describe): \_\_\_\_\_

- 6. First Point of Impact? (Illustrate on diagram on state collision report.)
- 7. Contributing Circumstances?

**Driver Action**

- Speed
- Failed to yield right-of-way
- Passed stop sign
- Disregarded signal
- Drove left of center
- Improper overtaking
- Made improper turn
- Followed too closely
- Backing
- Sudden movement
- Improper distance judgment
- No improper action

**Other Driver**

- Speed
- Failed to yield right-of-way
- Passed stop sign
- Disregarded signal
- Drove left of center
- Improper overtaking
- Made improper turn
- Followed too closely
- Backing
- Sudden movement
- Improper distance judgment
- No improper action

- 8. Other factors?

**Roadway**

- Defective surface
- Slippery
- Inoperative traffic signal
- View obstructed by object

**Vehicle Defect**

- Tires
- Brakes
- Lamps
- Steering
- No vehicle defect
- Other (describe): \_\_\_\_\_

9. Total number of lanes on roadway? \_\_\_\_\_
- 9A. Restricted access highway?  Yes  No
- 9B. Divided (median strip and/or center barrier between lanes of travel in opposite direction)?  
 Yes  No
10. Posted speed limit? \_\_\_\_\_
11. Approximate speed of the bus? \_\_\_\_\_
12. Was bus driver's lap/shoulder belt in use when the crash occurred? \_\_\_\_\_
13. Was school bus in use at time of crash?  Yes  No  
 If yes, check use:  
 Regular route  Special education use  
 Field/activity trip  
 Other use (describe): \_\_\_\_\_
14. Condition of road at time of crash?  
 Dry  Under repair  
 Icy  Snow packed  
 Holes or ruts  Muddy  
 Wet  
 Other (describe): \_\_\_\_\_
15. Light Condition?  
 Dawn  Dark (lighted)  
 Daylight  Dark (not lighted)  
 Dusk
16. Weather condition?  
 Clear  Raining  
 Sleetng  Fog  
 Snowing  Dust  
 Smog/Smoke  
 Other (describe): \_\_\_\_\_



**Loading/Unloading Crash**

1. At the time of the crash, where was the bus?

\_\_\_\_\_ Approaching the zone                      \_\_\_\_\_ Leaving the zone

\_\_\_\_\_ Stopped in the zone                      \_\_\_\_\_ Not in sight

2. Was the passenger(s)

\_\_\_\_\_ Hit by bus?                      \_\_\_\_\_ Hit by other vehicle?

3. Number injured? (See Injury Tally Sheet.) \_\_\_\_\_

4. Location of injured student(s)?

\_\_\_\_\_ On side of road                      \_\_\_\_\_ In roadway

\_\_\_\_\_ On sidewalk                      \_\_\_\_\_ Other(describe): \_\_\_\_\_

5. Description of behavior of student(s): \_\_\_\_\_

\_\_\_\_\_  
\_\_\_\_\_  
\_\_\_\_\_  
\_\_\_\_\_

6. Description of crash \_\_\_\_\_

\_\_\_\_\_  
\_\_\_\_\_  
\_\_\_\_\_  
\_\_\_\_\_  
\_\_\_\_\_  
\_\_\_\_\_

7. Diagram of crash:  
Complete the following diagram showing direction and position of vehicles involved, designating clearly the point of contact. (If this diagram will not serve for the accident in question, use adjacent space provided.)

**Diagram of crash**

**INDICATE BY ARROW**  
**DIRECTION OF NORTH**

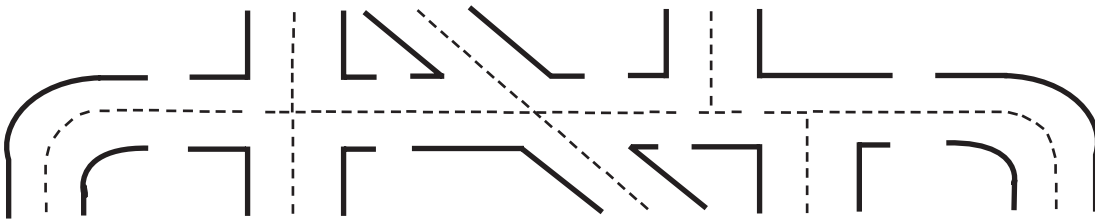

### Injury Tally Sheet

1. Ages and injury severities for all persons in bus? \_\_\_\_\_
  
2. Ages and injury severities for person(s) not in the bus, in loading/unloading area? \_\_\_\_\_

#### SCHOOL TRANSPORTATION-RELATED PERSONNEL

Age	On Board Bus										Off Bus Loading/Unloading Area									
	Killed				Injured						Killed				Injured					
					Serious		Moderate		Minor						Serious		Moderate		Minor	
		M		F		All		All		All		M		F		All		All		All
Under 5	01		02		03		04		05		06		07		08		09		10	
5	11		12		13		14		15		16		17		18		19		20	
6	21		22		23		24		25		26		27		28		29		30	
7	31		32		33		34		35		36		37		38		39		40	
8	41		42		43		44		45		46		47		48		49		50	
9	51		52		53		54		55		56		57		58		59		60	
10	61		62		63		64		65		66		67		68		69		70	
11	71		72		73		74		75		76		77		78		79		80	
12	81		82		83		84		85		86		87		88		89		90	
13	91		92		93		94		95		96		97		98		99		100	
14	101		102		103		104		105		106		107		108		109		110	
15	111		112		113		114		115		116		117		118		119		120	
16	121		122		123		124		125		126		127		128		129		130	
17	131		132		133		134		135		136		137		138		139		140	
18	141		142		143		144		145		146		147		148		149		150	
Over 18	151		152		153		154		155		156		157		158		159		160	
Driver	161		162		163		164		165		166		167		168		169		170	
Others	171		172		173		174		175		176		177		178		179		180	
Totals	181		182		183		184		185		186		187		188		189		190	

REPORT SUBMITTED BY:

\_\_\_\_\_  
Signature

\_\_\_\_\_  
Name (Print)

\_\_\_\_\_  
Date

\_\_\_\_\_  
Position



## PLANNING SCHOOL SITES FOR SCHOOL BUS SAFETY

1. In the selection of school sites, major consideration should be given to the safety of students riding school buses. School buses will be forced to utilize the roads in and around the school site, plus public highways leading into the school area. High-density traffic flow near school exits and entrances due to the proximity of freeways, periodic commercial traffic or massive commuter traffic from industrial plants should be avoided. It must be recognized, in many cases, that the area designated for the school site has been selected prior to hiring an architect. It is suggested, therefore, that this information be issued to boards of education and municipal planning authorities alerting them to the dangers inherent in the process of site selection. It is also suggested that boards of education discuss the selection with the superintendent of schools, traffic engineers and the state office of school plant planning and solicit their help in evaluating possible school sites.
2. The location of the school plant on a site should be determined to provide a safe means of entrance and exit for all students. When boards of education are considering school sites, the state, county and local roads servicing the area should have a minimum 30-foot paved width where loading and unloading is contemplated off the main thoroughfare. If it is necessary to load or unload students on the main thoroughfare in front of the school, at least a 40-foot wide paved road should be provided.
3. All school bus traffic should be considered as one-way traffic flow, preferably with the entrance door side of the bus always next to the loading and unloading zone.
4. Whenever possible, separate pick-up and delivery points some distance from the teacher and student parking areas should be designated for parents, delivery, service, teacher and administrative traffic. Accident-inducing conditions are created by haphazard pick-up and delivery of students in the bus loading zones, particularly during inclement weather.
5. Whenever possible, roads that completely encircle a school should not be constructed. Areas that students must cross to engage in outside activities should be free of all vehicular traffic.
6. All school bus roads entering into or exiting from main arteries should have a 50- to 100-foot radius turn on the inner edge of pavement. Within the school site, roads should have at least a 60-foot radius on the inner edge of pavement on all curves. At least a 50-foot tangent section should be provided between reverse curves. In order to minimize driveway entrance and exit widths, island construction may be required. Driveway openings must conform to local requirements and driveways opening onto state highways should be approved by the state highway department.
7. Curbing, with suitable drainage, should be constructed on all roads utilized by school buses within the school site. Consideration should be given to state highway department performance specifications. A minimum of 30 feet should be maintained for one-way traffic and 36 feet for two-way traffic, with roads being wider on all curves.
8. It is desirable to separate all parking areas; however, it might be advantageous if only the visitor parking area were located in close proximity to the school. Care should be exercised in the placement of these areas to preclude the visitor from crossing the school bus traffic pattern.
9. Prior to designing and laying out roads and parking lots, architects should consult with the school administration on the following items:
  - a. Total number of students and school personnel;
  - b. Number of present and projected students to be transported;
  - c. Number of buses;

- d. Type of schedule; and
    - (1) Staggered opening and closing times; and
    - (2) Single opening and closing times.
  - e. Extra-curricular activities that would necessitate use of school buses.
10. It is desirable to locate parked buses on school grounds to prevent glare from reflective surfaces of windows, doors and windshields from being transmitted to the students in the classroom.
  11. Attention should be given in planning school bus parking, loading and unloading areas. Parking should exclude the necessity for backing the bus.
  12. Sidewalk plans for students walking to school should eliminate crosswalks in front of the buses.
  13. Architects' plans for school buildings often include bus canopies. Such units are not considered feasible for schools with large enrollments. Canopies are advantageous in schools attended by students with disabilities. The height of the canopy should accommodate the highest school buses. Each canopy support post adjacent to the driveway curb should have a three-foot minimum setback from the curb to minimize the possibility of crushing a student between the support post and arriving school buses.
  14. For areas that will be constantly utilized by heavy school buses, the type of pavement and base should conform to state highway department specifications.
  15. All roads within the school site should be graded to avoid configurations that could impair a motorist's vision. It is suggested that a maximum 5% grade be allowed on all roads and, at entrance and exit points, a maximum 2% grade be allowed. Blind corners and intersections should be eliminated. Trees and shrubbery planted on the school site should not obstruct a motorist's vision.
  16. Plans for the location of access and service roads should exclude conditions that would require school buses to be backed on the school premises.
  17. Safety at all student loading and unloading areas should be considered and provided on the school site.
  18. Plans for loading facilities should include separate areas specially designed for students with disabilities. Attention should be given to entrance ramps and handrails.
  19. Plans for roads and loading areas should accommodate emergency vehicles which must have access to the school at all times.
  20. Where necessary, traffic control devices should be provided to assist school traffic to enter the regular traffic flow.

**Identification and Evaluation  
of  
School Bus Route and Hazard Marking Systems**

**Final Report**

**Work Performed Under a Grant From  
The National Highway Traffic Safety Administration  
U.S. Department of Transportation**

**Grant # DTNH22-97-G-05155  
June 1998**

**National Association of State Directors of Pupil Transportation**

**116 Howe Drive  
Dover, DE 1990 1\***

\*(Editor's note: This document is posted at the NASDPTS website: [www.nasdpts.org](http://www.nasdpts.org).)

## National Association of State Directors of Pupil Transportation

### **Background:**

An estimated 23 million public school students ride over 400,000 school buses twice daily to go to and from school. Additionally, it has been estimated that another one to two million students ride school buses to and from school-related activities each day. In the course of a school year, school buses transport students over four billion miles. The safety of pupil transportation is of significant concern to Federal, State and local governments, school districts, school administrators, parents, and the general public.

Within the school transportation industry itself, there is a long history of significant efforts to make school transportation safe and efficient. Pupil transportation programs date back to the earliest years of the 20th century. By 1910, thirty states had pupil transportation programs in place. The first “vehicles” used to transport students were nothing more than horse-drawn carts which were borrowed from local farmers. With the development of automobiles and trucks with gasoline-powered engines, the school “wagon” was replaced with the school “truck.” During the 1920’s and 1930’s, the Nation’s roadway system was expanding, especially in rural communities. This led to a greater need for vehicles to transport schoolchildren and the formation of an industry of school bus manufacturers.

As the number of school buses operating on the roadways increased, there came the inevitable problems. Several serious tragedies occurred involving school buses which caused school officials to think seriously about developing safety guidelines for school buses. In 1939, representatives from 48 states gathered to develop recommendations for school buses. Since that time, there have been a total of 12 National Conferences on School Transportation where representatives from each state gather to revise existing and establish new safety guidelines for school buses and operating procedures for the safe transportation of schoolchildren, including those with disabilities. The product of these national conferences are referred to as the National Guidelines for School Transportation. The National Conferences are jointly sponsored by the National Association of State Directors of Pupil Transportation Services (which includes the School Bus Manufacturers Technical Council), the National Association for Pupil Transportation, and the National School Transportation Association, the National Safety Council, and Central Missouri State University.

To help ensure the transportation safety of students on school buses, the National Highway Traffic Safety Administration (NHTSA) establishes and enforces a series of Federal Motor Vehicle Safety Standards governing the safety performance and manufacture of school buses. NHTSA also conducts a safety defects investigation program to identify safety defects in motor vehicles, including school buses, and requires manufacturers to recall and remedy defective vehicles free of charge. In addition, NHTSA’s Guideline #17, “Pupil Transportation Safety,” establishes minimum recommendations for a pupil transportation safety program, including the identification, operation, and maintenance of buses used for transporting students; training of passengers, pedestrians, and bicycle riders; and administration.

Even with the school bus-specific Federal Motor Vehicle Safety Standards, NHTSA’s safety defect investigation and recall program, NHTSA’s Guideline #17, and the school transportation industry’s National Guidelines for School Transportation, a few school bus safety problems continue to persist. One of these problems was identified as a contributing factor in a tragic crash that occurred on October 25, 1995, in Fox River Grove, Illinois. On that day, a commuter train hit a school bus that was stopped at a highway-railway grade crossing. Seven students were killed and the school bus driver and 24 other students were injured. The school bus driver had taken all of the appropriate actions prior to crossing the railroad tracks, but unknowingly failed to completely clear the railway track while the school bus was stopped at a red traffic light. The commuter train struck the rearmost side of the school bus.

At the conclusion of its investigation of the crash, the National Transportation Safety Board identified one of the factors contributing to the crash as an inadequate school district routing and hazard marking system. The Safety

Board noted that the substitute school bus driver operating the bus that day was unaware of the hazard at the highway-railroad crossing because “the methods employed by the school district to identify and evaluate route hazards were ineffective.”



In addition to the Safety Board's investigation of the Fox River Grove crash, the U.S. Department of Transportation formed a Grade Crossing Task Force to review the decision-making process for designing, constructing, and operating rail crossings. The Task Force published its findings in a March 1996 report, "Accidents That Shouldn't Happen." One recommendation from that report calls for NHTSA to "work with State directors of pupil transportation, through relevant national organizations, to develop a system to improve school bus routing safety by focusing on highway-railroad grade crossings."

As a result of the recommendations from the Safety Board and the Grade Crossing Task Force, NHTSA provided a grant to the National Association of State Directors of Pupil Transportation to:

1. Research the issue of school bus route hazards and route hazard marking systems;
2. Develop a set of guidelines that school transportation officials could utilize in developing a system for identifying school bus route hazards that meets the needs of their locality;
3. Provide suggestions for reasonable and appropriate means of informing school bus drivers of potential school bus route hazards so as to educate them on how to deal with any route hazards that can not be avoided; and
4. Suggest methods to disseminate the information developed during this project to the school transportation community.

### **School Bus Driver Training:**

School bus driver training is one of the most important components of the school bus transportation system. A critical component of school bus driver training is the recognition of potential driving hazards and appropriate adjustment of driving behavior to ensure the safety of the school bus occupants. The goal of this project and report is to provide school bus drivers and substitute drivers with a list of locations/situations that should be recognized as being potentially hazardous. School bus drivers should be properly trained to deal with these potentially hazardous conditions. In addition, school bus drivers should be trained to deal with hazardous conditions that occur suddenly or are of a temporary nature. Constant dialogue between school bus drivers and route planners is critical to ensure the continued safe transportation of students in school buses.

### **Methodology:**

The National Association of State Directors of Pupil Transportation undertook the following activities to develop a school bus route hazard identification system and a means of educating school bus drivers about such hazards. Each of the activities included review and comment by the various state directors of pupil transportation. Throughout this report, specific comments from states are included to illustrate the involvement and insight provided by the state directors.

#### **1. Define School Bus Route Hazard**

The first, and most critical, step was to develop an acceptable and reasonable definition of what constitutes a "school bus route hazard." From a practicable perspective, "school bus route hazards" can be grouped into two distinct categories. First, there are "driving hazards" that are encountered while operating a school bus route, such as railroad grade crossings and industrial intersections. Second, there are "school bus loading zone hazards" that are encountered at a school bus stop, such as a narrow, busy street without sidewalks or dangerous curves that do not provide the school bus driver, the students, or other motorists with an adequate view of the school bus loading zone. The scope of work for this project only included the first category of school bus route hazards - driving hazards.

2. **Develop a “Model” School Bus Route Hazard Identification System**

Based on the knowledge and expertise of individuals within the school transportation industry, an ideal program that could be used to assist states and local school districts in identifying and evaluating potential school bus route hazards was defined. This ideal program became the “model” against which existing school bus route hazard identification programs were compared.

3. **Review Existing Materials/Information**

Examples of existing state or local school district route hazard identification programs were reviewed and compared with the “model” system described above. The existing programs were reviewed in terms of the ability of the program to identify route hazards and communicate that information to the appropriate individuals.

4. **Develop a Recommended System**

Based on the review of existing programs, as compared to the “model” system, a recommended school bus driving route hazard identification system was developed that could provide states and local school districts with an efficient method for identifying potential school bus route hazards and a means of communicating information about those hazards to school bus drivers and trainers, route planners, and other appropriate school transportation officials.

5. **Dissemination Approaches**

Finally, suggestions were made on how to disseminate the “recommended” system to the school transportation community, and what approaches should be taken to educate state and local school transportation providers on the importance of adopting such a school bus driving route hazard identification system.

**Results of Program Activities:**

**Result #1 — Definition of a School Bus Route Driving Hazard**

While it is possible to develop a list of the potential hazardous locations/situations that a school bus driver could encounter in the course of driving a school bus route, it is not possible to develop a definitive list of every potential driving hazard. As was pointed out by the state of Indiana during discussions of this project, “Regular review of the route hazards list is encouraged. This will keep the document accurate and permit the addition of ‘yet-to-be-discovered’ hazards.”

Some potential school bus route driving hazards can be considered as “fixed,” in that the situation or condition exists (such as a railroad crossing), can be identified, and drivers can be informed and educated about the potential hazard. Other potential driving hazards occur without advanced warning — examples include: (1) inclement weather conditions, such as fog, sand storms, blinding sunlight, snow storms, etc.; (2) conditions that result from weather conditions, such as flooded roadways, fallen trees, downed power lines; and (3) accident locations. This report focuses on potential school bus route driving hazards that are of a “fixed” nature.

**Discussion:**

Table 1 details many of the potentially hazardous locations/situations that a school bus driver could encounter in the course of driving a school bus route. These potential driving hazards were selected based on the belief that the mere existence of any one of these conditions poses possible serious consequences if the school bus driver is not aware of the existence of the hazard. While a hazard could develop at any time while driving a school bus (for example, a tree could fall across a road during a storm, or a stream could overflow, or a wet road could suddenly ice over), this list defines only fixed conditions that, by their presence, have been deemed a potential driving hazard. Also, this list is

limited to the hazardous locations/situations encountered while driving the school bus, not during loading and unloading operations.

For each potential school bus route driving hazard, a list of factors or situations that could contribute to causing the hazard is provided. It is important to remember that this list of potential school bus route driving hazards, and the factors/situations within them, is not “all-inclusive.” States and local school districts may encounter factors and situations that are not listed in Table 1, but which they deem are potentially hazardous.

**Table 1.**

**List of Potentially Hazardous Locations/Situations on School Bus Routes**

**Railroad Grade Crossing**

- \* Number of tracks
- \* Visual obstructions to determine type and travel speeds of trains
- \* Train schedules (consider unscheduled trains also)
- \* Presence or absence of grade crossing controls
- \* Unique characteristics or operation of grade crossing controls
- \* Presence or absence of traffic control signals, including interaction with grade crossing controls
- \* Size of queuing area before and after the tracks
- \* Expected traffic conditions at various times during the day
- \* Roadway design near the grade crossing

**Dangerous Intersections and Roadways**

- \* High-frequency crash locations as defined by state transportation and/or law enforcement officials
- \* Uncontrolled intersections
- \* Curves and intersections with limited sight distances
- \* Areas with no shoulders or drop-off to shoulder
- \* Visibility of traffic control signals
- \* Coordination of traffic control signals with others in the immediate area

**Bridges, Tunnels/Underpasses and Overpasses**

- \* Weight capacity
- \* Height clearances
- \* Lane width

**Queuing/Storage Areas**

- \* Short acceleration/deceleration lanes
- \* Limited median areas crossing multi-lane highways
  - Turning lanes
    - Bus turnarounds
    - Areas that require backing of the bus to turnaround or park

**Industrial Intersections and Construction Zones**

- \* Areas where heavy vehicles/equipment operate on a regular basis, and may be entering, exiting, or crossing the roadway

**Steep Downgrades**

- \* Mountainous areas where brake condition and braking operations are important
- \* Location of out-of-control vehicle run-off areas

**Areas of Significant Speed Differential Between Vehicles**

- \* On-off ramps to high-speed roads
- \* Farm vehicle areas, including non-motorized vehicles on the road
- \* Mountain terrain

## **Pedestrian Areas**

- \* School bus loading/unloading zones
- \* Narrow streets with parked motor vehicles - children darting between vehicles
- \* Congested shopping and business areas
- \* Parks or intersections with pedestrian/bicycle paths

## **Other Conditions Identified in Local Area**

1. Unique roadway locations, for example:
  - a. Roadways without guardrails that are next to rivers, lakes, etc.
  - b. Dirt or gravel roads that could affect braking
  - c. Rock quarry or open pits
  - d. Areas with problems related to right-turn-on-red laws
  - e. Areas with visibility problems due to air quality/industrial smoke/etc.
  - f. Areas where emergency equipment operate on a regular basis
    - (1) fire stations
    - (2) hospitals

## **Result #2 - Development of a “Model” School Bus Route Hazard Identification System**

During the course of this project, a “model” school route hazard identification system was outlined. It was recognized that such a system would consist of three major components:

1. A list of potential driving hazards;
2. A specified procedure/schedule for conducting on-site reviews of school bus routes; and
3. An efficient and effective means of informing school bus drivers of the presence of potential driving route hazards.

Of the three components, the first was determined to be the most critical, since without a definition of what constitutes a school bus route driving hazard, the other components would have little utility. Additionally, developing a procedure and schedule for reviewing school bus routes and an information dissemination plan were viewed as administrative policy decisions that were independent of the technical issues related to identifying potential school bus route driving hazards. Accordingly, the focus of the effort was placed on identifying and listing potential school bus route driving hazards.

An initial list of potential hazards was prepared during a Working Session of state directors during the 1997 annual conference of the National Association of State Directors of Pupil Transportation Services. The results of that session were summarized and provided for review to all state directors of pupil transportation. The final results of that effort are discussed in the previous section of this report, “Result #1 - Definition of a School Bus Route Driving Hazard.”

## **Result #3 — Review of Existing Materials/Information**

A review of existing school bus route hazard identification systems was made to see if any system assessed all of the potential driving hazards developed during the Working Session at the 1997 annual conference. Not one was found. However, this effort identified additional potential hazards that were not previously considered, but were ultimately included in the final list of school bus route driving hazards as defined in Result #1 above.

## **Result #4 — Defining a Route Hazard Identification System**

The major goal of this project was to develop a system that a state or a local school district could use to:

- \* Identify any fixed locations/situations that constitute a potential school bus driving hazard; and.

\* Inform school bus drivers and substitute drivers of each identified potential route hazard on the school bus route(s) they drive.

### **Identification**

The first component of such a system would consist of an established, systematic process to evaluate all school bus routes to determine whether any potential fixed driving hazards exist. An annual review of each school bus route by a person trained to identify potential route driving hazards would provide the basis for identifying any potential hazards. In addition, school bus drivers should be trained in how to recognize a potential school bus route driving hazard, and to report any new potential hazardous conditions to the appropriate school transportation officials. In effect, this would provide for continual monitoring and review of school bus routes so school bus drivers are aware of all potential fixed driving hazards on their routes. As stated by Connecticut, “constant communication between school bus drivers and route planners is critical to safety.” Hazards can and do change, even on a daily basis. As such, “daily updates of critical route hazards should be foremost in the minds of dispatchers and drivers.” A checklist format based on the above list of potential school bus driving route hazards (Result #1 — Table 1) would provide for a consistent means of ensuring that such items were considered during the review of each school bus route. An example of such a checklist for the items identified in Result #1 appears as Appendix A to this report,\* and is based on a format utilized in Oklahoma. It is important to remember that a state or a local school district should ensure that any potential hazards that may be unique to their area, or any potential hazards that they believe were missing, are added to the checklist. In addition to regular school bus routes, there also can be potential driving hazards along routes taken for field trips or extra-curricular activities. In such cases, drivers may be able to identify potential route driving hazards based on their personal knowledge of the route or on a previous trip to the same location.

*\* Report being quoted above; checklist found in the appendix following.*

### **Information**

The second component of a school bus route driving hazard identification system consists of a means of informing all regular and substitute school bus drivers of the potential driving hazards on their school bus route(s). New Jersey stressed the importance of “the need for drivers and driver trainers to make clear notes of these hazards for all substitute drivers.” In addition to the drivers, school bus route planners/schedulers/dispatchers, etc. should be made aware of all information about potential driving hazards on the school bus routes. This information would allow them to make changes or adjustments to the routes, when reasonable and practicable, so as to minimize or eliminate the exposure of school buses to these route driving hazards. Informing the necessary people about potential school bus route driving hazards can be accomplished in a number of ways. The most practical, and possibly most easily understandable, appears to be through the use of a map that is visually annotated to identify potential route hazards. The same map could obviously be used for other purposes, including designating the actual school bus route and student pick-up/drop-off locations. Additionally, as the states of Ohio and Virginia noted in their comments to this project, information on the location of police/fire/rescue stations, hospitals, and other emergency care facilities, and “possible ‘safe stops’ where a school bus may pull off the road and await aid in the event of an emergency” could be added to the map. A number of local school districts currently use mapping techniques to document the streets in their district, the location of the students’ homes, the school bus stops, and the routes traveled by school buses. Inexpensive color printers allow school districts to print color maps of their bus routes, and computer software allows route planners to incorporate custom information, such as route hazards, on the map. Whatever means is chosen, it is important that school bus drivers be provided with route hazard information in a standardized, consistent manner. Also, the route hazard information should be available to the school bus driver every day, no matter which school bus is driven on that day.

### **Training**

While not a specific part of this project, the importance of training school transportation providers about school bus route driving hazards can not be understated. In their comments, Ohio noted that the contents of a route hazard identification system are “only good if utilized.” In other words, if drivers are not made aware of the potential driving hazards and trained on how to deal with such potential hazards, then no benefits will accrue from efforts to

identify potential route hazards. Mississippi commented that its training in route hazards constantly works “to instill in each driver the concept of Expect the Unexpected.”

However, training alone does not guarantee success. As Connecticut stated, “Route hazards is an area in which some training can be afforded, but common sense and networking among drivers, local officials, and school district personnel is paramount to a safe and successful route hazard notification program.”

### **Result #5 - Dissemination Approaches**

Based on the belief that the ultimate success of a school bus route driving hazard identification system is dependent on the awareness and use of the system by school transportation providers, it is strongly suggested that the results of this project be provided to all state directors of pupil transportation, the appropriate student transportation officials in each school district, and organizations affiliated with private/parochial schools. The dissemination to state directors and public schools districts could be made by use of direct mailings. The dissemination to private/parochial schools could be made through national associations that represent such schools.

As a supplement to direct mailings, the report on this project should be made available on the NHTSA and various school transportation web sites in a form that can be downloaded. In addition, the results of this project should be publicized through the various media that deal with pupil transportation.

### **Non-Fixed School Bus Route Hazards:**

As mentioned earlier, this project only dealt with school bus route driving hazards that are “fixed.” However, it is recognized that other driving hazards can occur without advanced warning. These often result from inclement/adverse weather conditions or poor visibility conditions. It is important for school bus drivers to be aware of such possibilities and be trained on how to deal with such sudden potential hazards. As an example of some non-fixed driving hazards, Iowa includes in its School Bus Driver’s Handbook procedures to follow should a school bus encounter a tornado or Agri-Chemical clouding along school bus routes. Also, Delaware provides drivers with information in its School Bus Driver’s Handbook to prepare them for the following:

#### Adverse weather conditions

- \* Extreme
- \* Extreme heat
- \* Rain
- \* Fog
- \* Snow/ice

#### Conditions affecting visibility

- \* Sun glare
- \* Darkness
- \* Curves and hills

Wild animals are another example of a non-fixed school bus route driving hazard. In many rural and suburban areas, animals such as deer and livestock can be a serious danger to motorists. School bus drivers should be made aware of such situations and learn how to deal with them.

### **Conclusions:**

Recognizing the importance of identifying school bus route driving hazards, the National Association of State Directors of Pupil Transportation Services has conducted this study for the National Highway Traffic Safety Administration. Verbal and written information from members of the Association was consolidated to focus on the key issues and the best approach for addressing the problem of driving hazards on school bus routes. The following conclusions were reached during the study:

- \* Driving hazards can and do exist on school bus routes.
- \* Driving hazards on school bus routes that are of a “fixed” nature can be identified.
- \* School transportation officials should establish a program to routinely and systematically evaluate all school bus routes for potential driving hazards.
- \* A list of potential fixed school bus route driving hazards has been developed for use in evaluating school bus routes.
- \* Information on potential school bus route driving hazards should be provided to all regular and substitute school bus drivers, route planners, dispatchers, and other appropriate personnel.
- \* School bus drivers should be trained on how to effectively deal with potential school bus route driving hazards, of both a fixed or sudden nature.

The results of this project should receive wide dissemination.

The National Association of State Directors of Pupil Transportation encourages states, local school districts, and private/parochial schools to review this report in conjunction with their school transportation operations and take whatever actions are necessary to ensure that school bus route driving hazards are identified and made known to all appropriate school bus drivers and school transportation personnel.



(Reference Table 1 Report)  
**Appendix A**  
**Checklist for Identifying Potential School Bus Route**  
**Fixed Driving Hazards**

**Railroad Grade Crossings**

Railroad Grade Crossing Identification Number: \_\_\_\_\_

Location: \_\_\_\_\_

How many tracks are present? \_\_\_\_\_

What are the times of the scheduled trains? \_\_\_\_\_

What types of trains use the track? Passenger \_\_\_\_\_ Freight \_\_\_\_\_ Commuter \_\_\_\_\_

What are the travel speeds of the scheduled trains? \_\_\_\_\_

	Yes	No
* Are the regulatory signs (crossbucks) clearly visible?	_____	_____
* Are there regulatory devices (lights/gates/bells) present?	_____	_____
* Are there any unique characteristics to the operation of the crossing controls?	_____	_____

What are they? \_\_\_\_\_

\* When stopped approximately 15 feet from the nearest railroad track, is there an unobstructed sight distance of approximately 1,000 feet in both directions? \_\_\_\_\_

\* Is there at least enough room on the other side of the furthest railroad track for the largest school bus to stop without encroaching on the train's right-of-way? \_\_\_\_\_

\* Are there any roadway design features that could affect the safe operation of a school bus at the railroad crossing? \_\_\_\_\_

What are they? \_\_\_\_\_

**Dangerous Intersections and Roadways**

Location \_\_\_\_\_

	Yes	No
* Is this a high-frequency crash location?	_____	_____
* Are traffic control devices present?	_____	_____
* Are there visibility obstructions?	_____	_____
What are they? _____		
_____		
* Are there areas with no shoulders <u>or drop to shoulder</u> ?	_____	_____
* Are there peculiar roadway features?	_____	_____
What are they? _____		
_____		

### Bridges, Tunnels/Underpasses and Overpasses

Location \_\_\_\_\_

	Yes	No
* Is the weight capacity of the bridge/overpass sufficient for a fully-loaded school bus?	_____	_____
* Is the height of the tunnel/underpass adequate for the tallest school bus, including open roof hatches?	_____	_____
* Is the lane width of the bridge, tunnel/underpass, or overpass adequate for the widest school bus, including the mirrors?	_____	_____

### Queuing /Storage Areas

Location \_\_\_\_\_

	Yes	No
* Is there sufficient area for the largest school bus in the acceleration/deceleration lane?	_____	_____
* Is there sufficient area for the largest school bus in the median area between a multi-lane road?	_____	_____
* Is there sufficient area for the largest school bus in the turning lane?	_____	_____

**Industrial Intersections and Construction Zones**

**Steep Downgrades**

Location \_\_\_\_\_

	Yes	No
* Do heavy vehicles enter/exit/cross the roadway frequently?	_____	_____
* Are there highway signs alerting drivers of the industrial/construction traffic?	_____	_____
* Are there highway signs alerting drivers to the downgrade?	_____	_____
* Are there signs alerting drivers to "Check Brakes?"	_____	_____
* Are there areas marked and designated for vehicles to safely leave the road (run-off areas)?	_____	_____

**Areas of Significant Speed Differential Between Vehicles**

Location \_\_\_\_\_

	Yes	No
* Is there sufficient space to accelerate/decelerate a school bus when entering/exiting a high-speed road?	_____	_____
* Does slow-moving farm equipment operate on the road?	_____	_____
* Do non-motorized vehicles, e.g., horse-drawn carriages, operate on the road?	_____	_____
* Are there roadway conditions, e.g., mountainous terrain, that result in vehicles operating at high speeds and low speeds?	_____	_____

What are they? \_\_\_\_\_

\_\_\_\_\_

**Pedestrian Areas**

Location \_\_\_\_\_

	Yes	No
* Are there difficulties seeing pedestrians at school bus stops?	_____	_____
* Are there narrow streets with parked vehicles where children may run into the street?	_____	_____
* Are there areas of heavy pedestrian congestion, e.g., shopping and business areas?	_____	_____

**Other Conditions Identified in Local Area**

Location \_\_\_\_\_

	Yes	No
* Are there unique roadway conditions?	_____	_____
* Roads without guardrails that pose a danger, e.g., next to rivers, lakes, quarries?	_____	_____
* Dirt or gravel roads that could affect braking?	_____	_____
* Others?	_____	_____
What are they? _____		
_____		
* Are there roadway conditions that make it difficult to make a "right turn on red?"	_____	_____
What are they? _____		
_____		
* Are there areas with visibility problems due to industrial smoke, air quality, etc.?	_____	_____
* Are there areas where emergency equipment operate on a regular basis, e.g., fire stations or hospitals?	_____	_____

## **POLICIES, PROCEDURES AND TOPICS FOR STUDENT MANAGEMENT**

Policies and procedures which address the following topics should be developed and implemented by school districts:

1. The bus driver's authority over, and responsibility for, students while in transit;
2. The student's right to due process when disciplinary action is taken;
3. A step-by-step procedure for resolving problems when the driver needs assistance;
4. The conditions under which a student might be temporarily or permanently suspended from the bus-riding privilege;
5. Procedures for handling emergencies;
6. Use of bus attendants or monitors;
7. Requirements and responsibility for school bus passenger and pedestrian safety instruction;
8. Parent's or guardian's responsibility for damage caused by their children to the bus or its equipment;
9. Rules and procedures for safe travel;
10. Driver, attendant, student and parent training for student management;
11. Special needs—teamwork, collaboration, and communication between transportation staff, special education staff, health services personnel and parents in the development of an Individualized Transportation Plan (ITP) for each student with a defined disability;
12. Rules and procedures for safe travel; and
13. Driver, attendant, student and parent training for student management.

**EVALUATION CHECKLIST FOR SCHOOL BUS  
DRIVEWAYS IN THE VICINITY OF THE SCHOOL**

NAME OF THE SCHOOL: \_\_\_\_\_ DATE: \_\_\_\_\_

LOCATION OF THE SCHOOL: \_\_\_\_\_

	YES	NO	DOES NOT APPLY
1. School bus loading areas are provided on the school site.	<input type="checkbox"/>	<input type="checkbox"/>	<input type="checkbox"/>
2. When loading and unloading of school students take place on a main thoroughfare in front of the school, the roadway has a minimum width of 40 feet of hard surface.	<input type="checkbox"/>	<input type="checkbox"/>	<input type="checkbox"/>
3. The driveway leading to and from the loading and unloading area for school buses has a minimum width of 30 feet of paved surface.	<input type="checkbox"/>	<input type="checkbox"/>	<input type="checkbox"/>
4. If diagonal parking is provided for buses in the loading and unloading area, a minimum width of 60 feet of paved surface is available.	<input type="checkbox"/>	<input type="checkbox"/>	<input type="checkbox"/>
5. Parking for loading and unloading of students at school is bumper-to-bumper or diagonal; in either case, the necessity for backing does not exist.	<input type="checkbox"/>	<input type="checkbox"/>	<input type="checkbox"/>
6. The school bus is not required to back anywhere on school property.	<input type="checkbox"/>	<input type="checkbox"/>	<input type="checkbox"/>
7. All school bus movement on the school grounds is one-way in a counter-clockwise direction.	<input type="checkbox"/>	<input type="checkbox"/>	<input type="checkbox"/>
8. School bus traffic does not completely encircle the school building.	<input type="checkbox"/>	<input type="checkbox"/>	<input type="checkbox"/>
9. The driver has proper sight distance at all points along the driveway.	<input type="checkbox"/>	<input type="checkbox"/>	<input type="checkbox"/>
10. Crosswalks for students do not exist at the entrance to the school bus driveway.	<input type="checkbox"/>	<input type="checkbox"/>	<input type="checkbox"/>
11. Separation is maintained between school bus traffic and all other traffic.	<input type="checkbox"/>	<input type="checkbox"/>	<input type="checkbox"/>
12. Vehicular pick-up points for non-bus students are on a separate driveway from that used by school buses.	<input type="checkbox"/>	<input type="checkbox"/>	<input type="checkbox"/>
13. Curbing and suitable drainage are provided along driveways.	<input type="checkbox"/>	<input type="checkbox"/>	<input type="checkbox"/>

		YES	NO	DOES NOT APPLY
14.	Curbing and driveway construction comply with state highway specifications.	<input type="checkbox"/>	<input type="checkbox"/>	<input type="checkbox"/>
15.	At ingress and egress areas to and from the school, there is a minimum radius on inner edge of driveway pavement from 50 to 100 feet.	<input type="checkbox"/>	<input type="checkbox"/>	<input type="checkbox"/>
16.	On the school site, there is a minimum radius of inner edge of driveway pavement of 60 feet.	<input type="checkbox"/>	<input type="checkbox"/>	<input type="checkbox"/>
17.	Between reverse curves, at least a 50-foot tangent section is provided.	<input type="checkbox"/>	<input type="checkbox"/>	<input type="checkbox"/>
18.	At ingress and egress points a maximum grade of 2% is adhered to.	<input type="checkbox"/>	<input type="checkbox"/>	<input type="checkbox"/>
19.	A maximum grade of 5% is adhered to on the school bus driveway within the school site.	<input type="checkbox"/>	<input type="checkbox"/>	<input type="checkbox"/>

**Note:** A “yes” answer for each of the items indicates a well-planned traffic pattern for school buses.

**SIGNATURES:**

Person making the report: \_\_\_\_\_

Title: \_\_\_\_\_

Director of School Transportation: \_\_\_\_\_

**Note:** Most of the items included in this Evaluation Checklist are based on a 1966 Report of the Special Committee on School Plant Evaluation “School Planning: Safe Transporting,” Bureau of Pupil Transportation, Department of Education, Trenton, New Jersey 08652.

**STUDENT RULES**  
**Supervision and Disciplinary Guidelines**

1. Student shall follow directions of the driver the first time given.
2. Student shall arrive at the bus stop before the bus arrives.
3. Student shall wait in a safe place, clear of traffic and away from where the bus stops.
4. Student shall wait in an orderly line and shall avoid horseplay.
5. Student shall cross the road or street in front of the bus only after the bus has come to a complete stop and upon direction of the driver.
6. Student shall go directly to an available or assigned seat when entering the bus.
7. Student shall remain seated and keep aisles and exits clear.
8. Student shall exhibit classroom conduct at all times.
9. Student shall refrain from throwing or passing objects in, from or into buses.
10. Student is permitted to carry only objects that can be held on his/her lap.
11. Student shall not use profane language, obscene gestures, tobacco, alcohol, drugs or any other controlled substance in the bus.
12. Student shall refrain from eating and drinking in the bus.
13. Student shall not carry hazardous materials or non-service animals into the bus.
14. Student shall respect the rights and safety of others.
15. Student shall refrain from leaving or boarding the bus at locations other than the assigned stop.
16. Student shall refrain from extending head, arms or objects out of the bus windows.
17. Student shall refrain from hitching rides via the rear bumper or other parts of the bus.



**BUS CONDUCT REPORT**

BUS NO. \_\_\_\_\_ SCHOOL: \_\_\_\_\_ DATE: \_\_\_\_\_

Students in the School District who ride buses are subject to rules and regulations designed to provide safe transportation to and from school. Any behavior which distracts the driver is a serious hazard to the safe operation of the vehicle, and as such, jeopardizes the safety of all passengers. Consequence of continued inappropriate behavior could result in your child being denied the bus riding privilege.

\_\_\_\_\_ has been cited for an infraction of the rule(s) checked below:  
(name)

- |  |   |
|--|---|
| <input type="checkbox"/> Failure to remain seated                | <input type="checkbox"/> Lighting matches             |
| <input type="checkbox"/> Scuffling or fighting                   | <input type="checkbox"/> Throwing objects from window |
| <input type="checkbox"/> Profanity or obscene language           | <input type="checkbox"/> Refusing to obey driver      |
| <input type="checkbox"/> Smoking in the bus                      | <input type="checkbox"/> Bothering others             |
| <input type="checkbox"/> Extending arm or head out window        | <input type="checkbox"/> Throwing objects in bus      |
| <input type="checkbox"/> Possession of harmful or illegal items. | <input type="checkbox"/> Other (See Comment)          |

COMMENT: \_\_\_\_\_  
\_\_\_\_\_  
\_\_\_\_\_

DRIVER'S SIGNATURE: \_\_\_\_\_ DATE: \_\_\_\_\_

PRINT NAME: \_\_\_\_\_

DATE OF OFFENSE: \_\_\_\_\_ FIRST OFFENSE: \_\_\_\_\_

SECOND OFFENSE: \_\_\_\_\_ THIRD OFFENSE: \_\_\_\_\_

SCHOOL ADMINISTRATOR'S ACTION: \_\_\_\_\_  
\_\_\_\_\_

SCHOOL ADMINISTRATOR'S SIGNATURE: \_\_\_\_\_ DATE: \_\_\_\_\_

PRINT NAME: \_\_\_\_\_

PARENT/GUARDIAN'S COMMENT: \_\_\_\_\_  
\_\_\_\_\_  
\_\_\_\_\_

PLEASE SIGN AND RETURN TO SCHOOL ADMINISTRATOR

Parent's/Guardian's Signature: \_\_\_\_\_ Date: \_\_\_\_\_

Print Name: \_\_\_\_\_

White Copy: School Administrator   Canary Copy: Bus Driver   Pink Copy: Parent/Guardian   Gold Copy: Student

[**Note:** A form, such as the one above, should be used for reporting purposes. First offenses require at least a notification to the student and parent or guardian (either by phone or in person) by appropriate school personnel. Second and subsequent offenses may require a conference with the student, parent or guardian, driver and school administrator(s), which may result in a period of suspension of the student's riding privileges.]

WHEN LEAVING YOUR BUS:

## Here's How to Cross the Road **SAFELY**

**WALK**—along the side of the road until  
you can see your driver

**STOP**—wait for the signal to cross

**WALK & LOOK**—for traffic both ways

—if you see a vehicle that has not  
stopped, go back to the bus immediately

—if all vehicles have stopped, cross the road quickly.

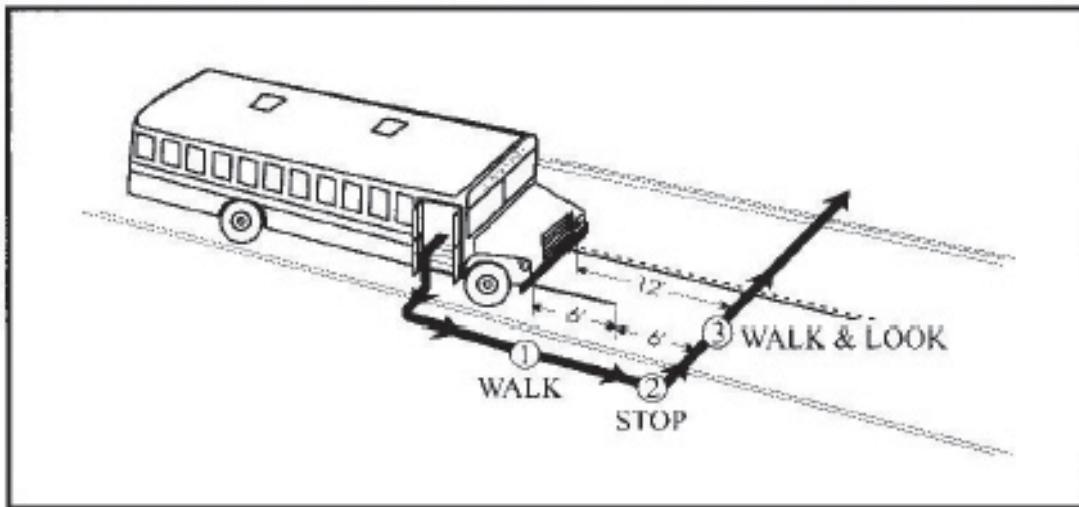

*Crossing the Highway is DANGEROUS*

**REMEMBER** |

- WALK
- STOP
- WALK & LOOK

**Drivers SHOULD stop...But  
THEY MAY NOT!**

WHEN BOARDING YOUR BUS:  
Here's How to Cross the Road  
**SAFELY**

FOLLOW THE 12 FOOT RULE:

**STAY**—on your side of the road—far away from the traffic

**WAIT**—for the bus to stop and for your driver's signal to cross

**CHECK**—traffic both ways—then check again

**CROSS**—walk directly across, checking traffic both ways

**WALK**—approximately 12 feet ahead of the bumper and board the bus quickly

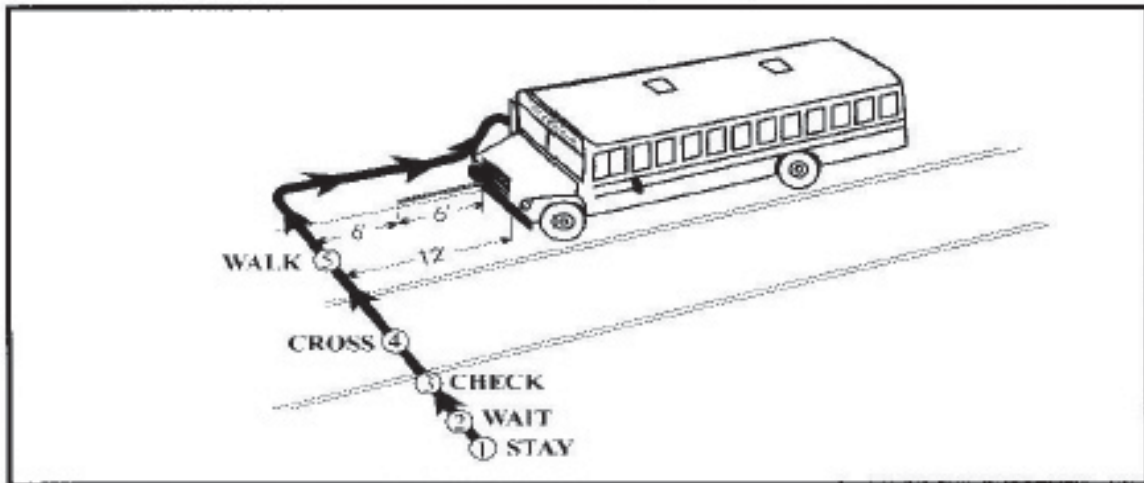

Crossing the Highway is *DANGEROUS*

**REMEMBER**

- Stay on your side of the road until your driver signals you to cross
- Check and recheck for traffic
- Follow the 12 foot rule
- Board bus quickly—go directly to your seat.

**Drivers SHOULD stop...But  
THEY MAY NOT!**

## **RECOMMENDED PROCEDURES FOR SCHOOL BUS DRIVERS AT RAILROAD GRADE CROSSINGS**

Each year, approximately 4,000 train/vehicle collisions occur at railroad crossings. These 4,000 collisions result in about 500 fatalities and 1,500 injuries. Unfortunately, some of the crashes involve school buses that result in injuries and fatalities to students. In an effort to avert these crashes, the following procedures are recommended to school bus drivers. It is important to note that these recommendations must be considered within the context of individual state laws and regulations.

1. When making stops for railroad crossings, carefully observe all traffic. Use the school bus's hazard warning lamps, and tap the brakes to communicate to traffic that the bus is about to stop. Take these actions far enough in advance to avoid startling motorists behind the bus, which could cause panic stops or rear-end collisions.
2. Bring the bus to a full and complete stop before crossing any track, whether or not the bus is carrying passengers. Stop the bus not less than 15 feet or more than 50 feet from the rails nearest the front of the bus.
3. On multiple-lane roads, stop only in the right lane unless it is necessary to make a left turn immediately after crossing the railroad tracks.
4. After stopping the bus, fully open the entrance (service) door and the driver's side window, turn off all noisy equipment (radios, fans, etc.), instruct students to be quiet, and look and listen in both directions along the track or tracks for approaching trains. In instances where the school bus loading/unloading red warning lamps are activated by opening the entrance (service) door, deactivate such lamps by using the master control switch.
5. If the view of the railroad track or tracks is not adequate, do not attempt to cross the tracks until you can see that no train is approaching.
6. If a train passes from one direction, make sure that another train, possibly hidden by the first train, is not approaching on an adjacent track.
7. For railroad crossings equipped with warning devices such as lights, bells, and/or gates, always obey the signals. Never ignore railroad crossing signals. If a police officer or flagman is present at the crossing, obey their directions, but be sure to make your own visual check.
8. Before crossing the tracks, ensure there is adequate room on the other side of the tracks and train right-of-way for the entire bus. It is always possible that the bus may have to stop immediately after crossing the railroad tracks.
9. When the tracks are clear, completely close the bus entrance door and place the transmission in a gear that will not require changing gears while crossing the tracks. In instances where the loading/unloading red school bus alternately flashing signal lamps are activated by opening the entrance door and such lamps were deactivated by using the master control switch, reactivate the school bus loading/unloading lamps. Leave all noisy equipment turned off, and continue looking in all directions as the bus crosses the tracks. After safely crossing the tracks, turn off the hazard warning lamps.
10. If the bus stalls while crossing the tracks, evacuate the students and move them a safe distance away from the bus, as quickly as possible. If a train is approaching, have everyone walk in the direction of the train at a 45 degree angle away from the train tracks. If a radio or telephone is available, notify the school dispatcher of the situation.

11. Weather conditions, such as fog, snow, rain, and wind, can affect the driver's ability to see and hear an approaching train and to determine the safety of crossing railroad tracks.

Additional caution must be exercised during such conditions.

12. Report malfunctioning railroad signals or hazardous railroad crossing conditions to the appropriate school transportation personnel.

Additional information and training materials on railroad crossing safety are available from:

Operation Lifesaver, Inc.  
1420 King Street  
Alexandria, VA 22314  
1-800-537-6224

Although the information and recommendations contained in this publication have been compiled from sources believed to be reliable, other or additional safety measures may be required under particular circumstances.

(Adapted from Fact Sheet, "Recommended Procedures for School Bus Drivers at Railroad Crossings," revised, School Transportation Section, 1998, National Safety Council, 1121 Spring Lake Drive, Itasca, IL 60143-3201, (630) 285-1121.)

**TRIP REQUEST FORM**

Trip date: \_\_\_\_\_ School: \_\_\_\_\_

Trip destination: \_\_\_\_\_

Depart from: \_\_\_\_\_ No. passengers: \_\_\_\_\_

Departure time: \_\_\_\_\_ Arrival time: \_\_\_\_\_

Extra equipment: \_\_\_\_\_

Meal stop required?  yes  no If yes, where? \_\_\_\_\_

\_\_\_\_\_

Equipment that will need to be transported: \_\_\_\_\_

Special needs equipment requirements: \_\_\_\_\_

Overnight travel requirement: \_\_\_\_\_

Number of adults accompanying the students: \_\_\_\_\_

Transportation requested by: \_\_\_\_\_ Date: \_\_\_\_\_

Approved by: \_\_\_\_\_ Date: \_\_\_\_\_

Reimbursement category: \_\_\_\_\_

**TRANSPORTATION USE:**

Vehicle assigned: \_\_\_\_\_ Driver: \_\_\_\_\_

Spot time: \_\_\_\_\_ Spot location: \_\_\_\_\_

Routing information: \_\_\_\_\_

Dispatcher's signature: \_\_\_\_\_ Date: \_\_\_\_\_

Time out: \_\_\_\_\_ Time in: \_\_\_\_\_ Total time: \_\_\_\_\_

Mileage out: \_\_\_\_\_ Mileage in: \_\_\_\_\_ Total miles: \_\_\_\_\_

Actual no. passengers: \_\_\_\_\_

Remarks: \_\_\_\_\_

Driver's signature: \_\_\_\_\_ Date: \_\_\_\_\_

Pre-trip mechanical check completed (for overnight trips or trips exceeding \_\_\_\_\_ miles):

Technician's signature: \_\_\_\_\_ Date: \_\_\_\_\_

## INSTRUCTIONS FOR CONDUCTING EMERGENCY EXIT DRILLS

Due to the increased number of students being transported and the increased number of accidents on the highways, there is an urgent need to instruct students on how to properly vacate a school bus in case of an emergency. It is possible for students to block the emergency door if all are trying to get out at the same time. Also, there is a possibility of danger when students jump from the rear emergency door exit. To avoid these situations, schools should organize and conduct emergency exit drills for all students who ride the school bus, even occasionally.

### A. Reasons for actual emergency evacuations:

1. Fire or danger of fire. Being near an existing fire and unable to move the bus, or being near the presence of gasoline or other combustible material is considered dangerous, and students should be evacuated. The bus should be stopped and evacuated immediately if the engine or any portion of the bus is on fire. Students should be moved to a safe place 100 feet or more from the bus and instructed to remain there until the driver has determined that the danger has passed.
2. Unsafe position. When the bus is stopped because of an accident, mechanical failure, road conditions or human failure, the driver must determine immediately whether it is safer for students to remain in or to evacuate the bus.
3. Mandatory evacuations. The driver must evacuate the bus when the following situations arise:
  - a. Fire or threat of fire is apparent.
  - b. The final stopping point is in the path of a train or is adjacent to railroad tracks.
  - c. The stopped position of the bus may change and increase the danger (e.g., a bus comes to rest near a body of water or at a precipice where it could still move and go into the water or over a cliff). The driver should be certain that the evacuation is carried out in a manner which affords maximum safety for the students.
  - d. The stopped position of the bus is such that there is danger of collision.
4. Sight distance. In normal traffic conditions, the bus should be visible for a distance of 300 feet or more. A position over a hill or around a curve, where such visibility does not exist, should be considered reason for evacuation.

### B. Important factors pertaining to school bus evacuation drills:

1. Safety of students is of the utmost importance and must first be considered.
2. All drills should be supervised by the principal or by persons assigned to act in a supervisory capacity.
3. The bus driver is responsible for the safety of the students. When the driver is incapacitated and unable to direct the evacuation, school patrol members, appointed students or adult attendants should be authorized to direct these drills. It is important to have **REGULAR SUBSTITUTES AVAILABLE.**
4. IF OPERABLE, THE SCHOOL BUS ALTERNATELY FLASHING SIGNAL LAMPS (RED TRAFFIC CONTROL LAMPS) MUST BE ACTIVATED AND SIDE STOP ARM EXTENDED TO ALERT ONCOMING TRAFFIC.

5. Students appointed to direct evacuation drills should possess the following qualifications:
  - a. Maturity; and
  - b. Live near the end of the bus route.
6. Passengers should receive instruction on how to:
  - a. Turn off ignition switch/shut down engine;
  - b. Set emergency brake;
  - c. Summon help when and where needed;
  - d. Use kick out windows or emergency escape exits;
  - e. Set warning devices;
  - f. Open and close doors and account for all students passing the station;
  - g. Help small students off the bus;
  - h. Perform other assignments; and
  - i. Use of electronic voice equipment to summon help.
7. School bus driver and attendant should be active participants.
8. Drills should be scheduled in a manner similar to fire drills held regularly in schools. They should be held more often during fall and spring months and conducted when the bus arrives at the school building with the students.
9. Drills should be restricted to school property and conducted under the supervision of school officials.
10. Types of drills should be varied.
11. Driver should stay in bus during evacuation drill. He/she must set the parking brake, turn the engine off and place the manual transmission in gear.
12. Students should not be permitted to take lunch boxes, books, etc., with them when they leave the bus. (The objectives are to get students off safely in the shortest time possible and in an orderly fashion.)
13. Students should travel a distance of at least 100 feet from the bus in an emergency drill and remain there until given further directions.
14. All students should participate in the drill, including those who ride only on special trips.
15. Each student should be instructed in proper safety precautions.
16. Students should be instructed in how and where to obtain assistance in emergencies. Written instructions and telephone numbers should be posted in the bus.



17. Sample drill formats:
  - a. Everyone exits through the front entrance doors and emergency door configurations.
  - b. Everyone exits through the rear-most emergency door(s).
  - c. Front half exits through the front door and rear half exits through the rear-most door.
  - d. Other emergency exits (e.g., windows, hatches) are included in drills.
18. All rear-engine buses are equipped with a left side emergency exit door in lieu of a rear emergency door. This exit should also be utilized for evacuation drills.
19. Some states also require side emergency exits in addition to rear emergency doors.
20. Students should be familiar with the operation of emergency windows (both side and rear) and roof hatches. All exits should be opened by students during evacuation drills to ensure the students' ability to operate such devices.
21. All school bus drivers shall ensure the students assigned to their buses are familiar with the emergency exit configuration of their assigned bus.
22. Identification of seat rows and positions similar to airline seating is recommended (i.e., left front seat 1, a, b, c, right front seat 1, d, e, f, etc.)
23. Education staff and coaches should be trained regarding safe travel practices and procedures and should be required to participate in school bus evacuation drills.

**EVACUATION PROCEDURES**  
**for**  
**ACTIVITY TRIPS AND FIELD TRIPS**

In order to ensure the safety of school bus passengers in an actual emergency, every school bus driver assigned to transport students on activity trips or field trips may assign an evacuation team prior to each trip. The team may consist of teachers, coaches, students or any other passenger. A roster should be provided to the driver, accounting for all passengers.

Passengers assigned to evacuation teams must be seated where they can effectively carry out their responsibilities in an emergency.

Each evacuation team will consist of at least the following:

1. A passenger assigned to set the parking brake, turn off the engine, turn on warning flashers and to call on the radio or other means and report the incident to the Transportation Department, in case the driver is unable to do so.
2. A passenger assigned to lead passengers to a safe location at least 100 feet from the bus and to take the first aid kit off the bus.
3. Two passengers assigned to stand outside the bus, next to the entrance door, to help students exit the bus and to take the fire extinguisher.
4. Two passengers assigned to stand outside the bus, next to the emergency exit door, to help students exit the bus.

In addition to assigning an evacuation team, the following information shall be discussed and/or demonstrated prior to each activity trip or field trip:

1. Location and use of the fire extinguisher;
2. Location of the first aid kit;
3. Location of the warning reflectors;
4. Location and use of all emergency exits;
5. How to shut off the engine and set the parking brake;
6. How to open the entrance door, to include, safety releases on manual, air or vacuum doors, if so equipped; and
7. Importance of passengers keeping aisles clear at all times and not blocking emergency exits.

THE DRIVER OF THIS TRIP DID ASSIGN AN EVACUATION TEAM AND EXPLAINED THE EMERGENCY PROCEDURES AND SAFE TRAVEL RULES TO OUR GROUP.

Sponsor's/trip leader's signature: \_\_\_\_\_ Date: \_\_\_\_\_

## **OPERATIONAL GUIDELINES FOR THE USE OF BUSES OTHER THAN SCHOOL BUSES**

In order to ensure the safest transportation for school students, the following guidelines and procedures provide information that can be used by schools, school districts and others transporting pre-school and school-aged children when contracting for a school-charter motorcoach.

### **A. DRIVERS**

The following training requirements for school-charter motorcoach drivers MAY be considered:

#### **1. Pre-service training**

In addition to successfully completing all pre-service training provided by the employer, a school-charter motorcoach driver shall complete a required course of instruction which includes, but is not limited to, appropriate state laws, regulations and policies related to school transportation.

#### **2. In-service training**

All school-charter motorcoach drivers shall receive a required amount of in-service training annually, with instruction on handling bodily fluids, and shall be required to maintain a current first aid certificate.

### **B. MOTOR CARRIERS**

The following requirements for motor carriers MAY be considered:

#### **1. Pre-qualification list of eligible motor carriers**

The school district should establish a list of eligible companies that it will use for charter motorcoach service by pre-qualifying potential providers. Public school systems should establish this list centrally so that individual schools do not have to duplicate efforts of other schools, and so that motorcoach companies are not asked to provide the same information to multiple schools that are using the same criteria. Further, school districts may find it advantageous to join together in a consortium or other working group to cooperatively establish a regional list of eligible companies.

#### **2. Vehicle maintenance**

The school district should require assurance from the motor carrier that it will not knowingly require or permit the operation of any school-charter motorcoach that is not in safe operating condition or not equipped and maintained, as required by any law; or knowingly require or permit any driver to drive in violation of any law.

### **C. TRIP-SPECIFIC REQUIREMENTS**

The following requirements MAY be considered:

Based on specific needs of the trip, the school and the motor carrier must understand and establish in a written contract exactly what will be involved and establish methods for verifying that the motor carrier meets all criteria for a given trip.

## 1. Inspection

Prior to operation, the driver shall inspect each school-charter motorcoach to ascertain that it is in safe condition, it is equipped as required by all provisions of law, and all equipment is in good working order. The inspection shall include, but is not limited to:

- a. All required emergency equipment, as well as, first aid and body fluid cleanup kit(s), fire extinguisher(s), reflectors;
- b. All gauges, indicators and warning devices;
- c. Horn(s);
- d. Driver's seat and seat belts;
- e. All doors, door emergency releases, overhead hatches and windows;
- f. All seats, handrails and modesty panels;
- g. Interior and exterior lighting systems;
- h. All heating, cooling and ventilating systems;
- i. All glass and mirrors, including adjustment of mirrors;
- j. Windshield wipers and washers;
- k. All tires, wheels, rims and lug nuts;
- l. Wheelchair restraints, tiedowns and loading devices, such as ramps and lifts; and
- m. Brake system;
  - (1) Air compressor governor cut-in and cut-out pressures;
  - (2) Static pressure for air loss;
  - (3) Applied brake pressure loss;
  - (4) Low air pressure warning devices;
  - (5) Emergency stopping systems;
  - (6) Parking brake;
  - (7) Antiskid device (if equipped);
  - (8) Vacuum gauge, ensuring it reads not less than 15 inches of mercury (if equipped);
  - (9) Low vacuum warning device(s); and
  - (10) Brake pedal for brake adjustment.

**(Note:** Draining reservoirs in dual air systems is not required.)

2. Pre-trip inspection checklist

The coordinator of the trip should complete a pre-trip inspection checklist at the time of the trip to make sure that each driver and vehicle meet all criteria immediately before departure. Motor carriers are required to meet many Federal Motor Carrier Safety Regulations. The company is responsible for ensuring that each driver completes a thorough pre-trip inspection prior to each trip and is further required to repair any safety-related defects discovered prior to the trip. The completion of a pre-trip checklist by a trip coordinator does not relieve the company of the liability for the mechanical condition of the vehicle. The pre-trip checklist should validate the driver's medical card, CDL license with proper endorsement and a basic review of the vehicle (e.g. lamps, safety equipment, etc.).

3. Trip report

At the completion of the driver's work or tour of duty, each driver should submit a daily documented report to the employer indicating the condition of the vehicle and noting any defects found. Whether discovered by or reported to the driver, all vehicle defects and deficiencies likely to affect safe operation or cause mechanical breakdown of the school-charter motorcoach shall be listed, and a negative report shall indicate that no such conditions are present.

4. Transportation of property:

a. Hazardous materials

Motor carriers and drivers shall not transport, or knowingly permit passengers to carry, any substance, material, or device posing an unreasonable risk to health and safety to any passenger. These restrictions shall not apply to:

- (1) Portable oxygen tanks medically prescribed for, and in the possession of, a passenger and in a carrier designed for personal use;
- (2) Personal-use articles in the immediate possession of a passenger; and
- (3) Hazardous materials transported by a carrier subject to federal jurisdiction in compliance with provisions of Sub-part E, Part 177, 49 CFR.

b. Fuel

Fuel shall not be transported except in the vehicle's regular fuel tanks.

c. General property

Drivers and motor carriers shall not permit any greater quantity of baggage in vehicles than can be safely and conveniently carried and safely secured. In no event shall aisles, doors, steps or emergency exits be blocked.

d. Animals

A driver or motor carrier may refuse to transport dogs or other animals except certified guide, signal or service animals. All other animals shall be securely crated and stored to eliminate the possibility of injury to passengers.

5. Transportation of passengers:

The driver shall not drive a school-charter motorcoach transporting passengers in violation of the following provisions:

a. Emergency procedures and passenger safety training

School passengers transported in school-charter motorcoaches shall receive emergency procedure and passenger safety training as prescribed by state law and/or regulations for school passengers transported in yellow school buses. Training shall include evacuation training on the specific charter motorcoach being used for each trip.

b. Interior lighting

During darkness, the driver shall ensure that the interior lighting is sufficient for passengers to enter and exit safely and whenever otherwise deemed necessary.

c. Ejection of passengers

The driver of a school-charter motorcoach shall not eject any school student-passenger unless the passenger is given into the custody of a parent, guardian or any person designated by the parent, guardian, school authority or law enforcement official.

d. Fueling restrictions

No fueling will take place while passengers are on board the bus.

e. Seating capacity

The number of passengers (excluding infants in arms) shall not exceed the number of safe and adequate seating spaces.

f. Weight

Passengers shall not exceed the number whose weight, in addition to the weight of any property transported, can be carried without exceeding the manufacturer's maximum gross vehicle weight rating or the combined maximum rating of the tires supporting each axle.

g. Standing passengers

A school-charter motorcoach with school passengers on board shall not be put in motion until all passengers are seated. All passengers must remain seated while the vehicle is in motion, except an adult chaperone, parent, guardian or school employee acting upon a request by the driver to supervise or assist a passenger or when it is necessary for a passenger to use the on-board restroom at a location where the bus cannot be stopped in a safe place. Passengers shall not be permitted in front of the "standee line" while the vehicle is in motion.

h. Open doors

A school-charter motorcoach shall not be put in motion until the doors are closed. The doors shall not be opened until the vehicle is stopped and the parking brake applied.

i. Emergency exits

A school-charter motorcoach shall not be put in motion with any emergency exit locked or otherwise secured against being opened from the inside or outside.

6. School-charter motorcoach accident reporting and mechanical failure
  - a. Whenever any school-charter motorcoach accident occurs, the driver shall stop at the scene, immediately notify or cause to be notified the state agency responsible for investigating accidents involving buses engaged in the transportation of school students, his or her employer, and the school district or school which the students may attend.
  - b. In the event of an accident or emergency, the driver shall not leave the immediate vicinity of the school-charter motorcoach to seek aid unless the bus is empty. If there are passengers on board no less than two should be sent to summon help.
  - c. Comply with Title 49 CFR Section 392.40.
  - d. When a school-charter motorcoach is rendered unsafe for continued operation due to accident damage or a mechanical failure, the driver shall discontinue use of the bus and notify the motor carrier of these circumstances. The driver or motor carrier shall then make the necessary arrangements to have the passengers safely transported to their destinations.
  - e. A school-charter motorcoach damaged by an accident or other cause shall not be driven from the location where the damage occurred until it has been inspected by a qualified person who has determined that the vehicle is safe to drive.
7. Other operational issues
  - a. Smoking is prohibited.
  - b. The driver's view in any direction shall not be obstructed by any passenger.
  - c. The driver shall wear the lap or lap/shoulder belt (as equipped) at all times while the bus is in motion.
  - d. Headlamps shall be illuminated at all times while the bus is in motion.
  - e. When any passenger is on board, the driver shall not leave the driver's compartment without first stopping the engine, setting the parking brake, placing the transmission in first or reverse gear or park position and removing the ignition keys (if applicable) which shall remain in the driver's possession. (On vehicles with automatic transmissions that do not have a park position, the transmission shall be placed in neutral.)
  - f. School districts shall ensure that motor carriers require each school-charter motorcoach driver to demonstrate proficiency in the safe operation of each different type and size of bus requiring different driving skills in conditions of daylight, darkness, roadway, and terrain before transporting passengers in those conditions or terrain. Drivers should also receive training in bus operations under all weather conditions likely to be encountered prior to operating such vehicle(s) in those conditions. Once driver proficiency has been recorded, motor carriers shall ensure that driver proficiency is maintained.
  - g. School districts shall ensure that motor carriers equip each school-charter motorcoach with at least one fully charged fire extinguisher having at least a 10 B:C rating. If the school-charter motorcoach has been designed or modified to transport passengers in wheelchairs, the vehicle shall be equipped with two extinguishers, each one rated at not less than 8 B:C one to be placed in the driver's compartment and the other at the wheelchair loading door or emergency exit. Each fire extinguisher shall be securely mounted in the school-charter motorcoach in a conspicuous place or in a clearly marked compartment, readily accessible. Each fire extinguisher shall be maintained in prescribed operating condition with a current inspection certification and equipped with some means of determining if it is fully charged.

h. First aid and body fluid cleanup kits

School districts shall require motor carriers to equip each school-charter motorcoach with readily visible, accessible and plainly marked first aid and body fluid cleanup kits. The kits shall be constructed to prevent dust and moisture from reaching the contents and must be maintained in good condition. The kits shall be removable from the place secured. The required contents of school-charter motorcoach first aid and body fluid cleanup kits shall conform to state requirements.



## Activity Bus Use for School Activity Trips

### A. General Provisions

1. Pre-service driver training

In addition to successfully completing all pre-service training provided by their employer, school activity bus drivers shall complete at least a state-required course of instruction.

2. In-service driver training

All school activity bus drivers shall receive the state-required amount of in-service training annually and shall be required to maintain a current first aid certificate with instruction in universal precautions.

3. Hours of service

Driver shall comply with the provisions of CFR 49, Part 395.5.

4. Specially equipped bus

School activity buses may be designed or modified in accordance with Federal Standards or the Americans with Disabilities Act requirements to transport passengers seated in wheelchairs.

5. Vehicle condition

It shall be unlawful for the driver to drive a school activity bus that is not in safe operating condition or is not equipped, as required by all provisions of law. The driver is solely responsible for the vehicle condition.

6. Pre-trip inspection

Prior to operation, the driver shall inspect each school activity bus to ascertain that it is in safe condition, it is equipped, as required by all provisions of law, and all equipment is in good working order. The inspection shall include, but is not limited to, the following items:

- a. All required emergency equipment, as well as, first aid and body fluid cleanup kit(s), fire extinguisher(s), reflectors;
- b. All gauges, indicators and warning devices;
- c. Horn(s);
- d. Driver's seat and seat belts;
- e. All doors, door emergency releases, overhead hatches and windows;
- f. All seats, handrails and modesty panels;
- g. Interior and exterior lighting systems;
- h. All heating, cooling and ventilating systems;
- i. All glass and mirrors, including adjustment of mirrors;
- j. Windshield wipers and washers;

- k. All tires, wheels, rims and lug nuts;
- l. Wheelchair restraints, tiedowns and loading devices (such as ramps and lifts); and
- m. Brake system.
  - (1) Air compressor governor cut-in and cut-out pressures;
  - (2) Static pressure for air loss;
  - (3) Applied brake pressure loss;
  - (4) Low air pressure warning devices;
  - (5) Emergency stopping systems\*;
  - (6) Parking brake;
  - (7) Antiskid device (if equipped);
  - (8) Vacuum gauge (if equipped), ensuring it reads not less than 15 inches of mercury;
  - (9) Low vacuum warning device(s); and
  - (10) Brake pedal for brake adjustment.

\*(**Note:** Draining reservoirs in dual air systems is not required.)

7. Daily report

At the completion of the driver's work or tour of duty, each driver shall submit a daily documented report to the employer indicating the condition of the vehicle and noting any defects found. Whether discovered by or reported to the driver, all vehicle defects and deficiencies likely to affect safe operation or cause mechanical breakdown of the school activity bus shall be listed, and a negative report shall indicate that no such conditions are present.

8. Repairs

The driver shall not make any repairs of the bus or its equipment except necessary emergency repairs on the road.

**B. Transportation of property**

1. Hazardous materials

Motor carriers and drivers shall not transport, or knowingly permit passengers to carry any substance, material or device posing an unreasonable risk to health and safety to any passenger. These restrictions shall not apply to:

- a. Portable oxygen tanks medically prescribed for, and in the possession of, a passenger and in a carrier designed for personal use;
- b. Personal-use articles in the immediate possession of a passenger; and
- c. Hazardous materials transported by a carrier subject to federal jurisdiction in compliance with provisions of Sub-part E, Part 177, 49 CFR.

2. Fuel

Fuel shall not be transported except in the vehicle's regular fuel tanks.

3. General property

Drivers and motor carriers shall not permit any greater quantity of baggage in vehicles than can be safely and conveniently carried and safely secured. In no event shall aisles, doors, steps or emergency exits be blocked.

4. Animals

A driver or motor carrier may refuse to transport dogs or other animals except certified guide, signal or service animals. All other animals shall be securely crated and stored to eliminate the possibility of injury to passengers.

**C. Transportation of passengers**

The driver shall not drive a school activity bus transporting passengers in violation of the following provisions:

1. Seating capacity

The number of passengers (excluding infants in arms) shall not exceed the number of safe and adequate seating spaces.

2. Weight

Passengers shall not exceed the number whose weight, in addition to the weight of any property transported, can be carried without exceeding the manufacturer's maximum gross vehicle weight rating or the combined maximum rating of the tires supporting each axle.

3. Step wells

Passengers shall not be permitted in front of the "standee line" while the vehicle is in motion.

4. Standing passengers

A school activity bus with school student-passengers on board shall not be put in motion until all passengers are seated. All passengers must remain seated while the vehicle is in motion, except an adult chaperone, parent, guardian or school employee acting upon a request by the driver to supervise or assist a passenger or when it is necessary for a passenger to use the on-board restroom at a location where the bus cannot be stopped in a safe place.

5. Open doors

A school activity bus shall not be put in motion until the doors are closed. The doors shall not be opened until the vehicle is stopped and the parking brake has been applied.

6. Emergency exits

A school activity bus shall not be put in motion with any emergency exit locked or otherwise secured against being opened from the inside or outside.

7. Interior lighting

During darkness, the driver shall ensure that the interior lighting is sufficient for passengers to enter and exit safely and whenever otherwise deemed necessary.
8. Ejection of passengers

The driver of a school activity bus shall not eject any school student-passenger unless the passenger is given into the custody of a parent, guardian or any person designated by the parent, guardian, school authority or law enforcement official.
9. Fueling restrictions.

No fueling will take place while passengers are on board the bus.
10. School activity bus accidents reporting
  - a. Whenever any school activity bus accident occurs, the driver shall stop at the scene, immediately notify or cause to be notified the state agency responsible for investigating accidents involving buses engaged in the transportation of school student-passengers, his or her employer, and the school district or private school for which the students may attend.
  - b. In the event of an accident or emergency, a driver shall not leave the immediate vicinity of the school activity bus to seek aid unless the bus is empty. If there are passengers on board, no less than two can be sent to summon help.
  - c. Comply with Title 49, CFR, Section 392.40
11. Discontinuance from use

When a school activity bus is rendered unsafe for continued operation due to accident damage or a mechanical failure, the driver shall discontinue use of the bus and notify the motor carrier of these circumstances. The driver or motor carrier shall then make the necessary arrangements to have the passengers safely transported to their destinations.
12. Smoking is prohibited
13. The driver's view in any direction shall not be obstructed by any passenger.
14. The driver shall wear the lap or lap shoulder belt (as equipped) at all times while the bus is in motion.
15. Headlamps shall be illuminated at all times while the bus is in motion.
16. When any passenger is on board, the driver shall not leave the driver's compartment without first stopping the engine, effectively setting the parking brake, placing the transmission in first or reverse gear or park position and removing the ignition keys (if applicable), which shall remain in the driver's possession. (On vehicles with automatic transmissions that do not have a park position, the transmission shall be placed in neutral.)
17. School districts shall ensure that motor carriers require all school activity bus drivers to demonstrate proficiency in the safe operation of each different type and size of bus requiring different driving skills in conditions of daylight, darkness, roadway and terrain before transporting passengers in those conditions or terrain. Drivers shall also receive classroom training in bus operations under all weather conditions likely to be encountered prior to operating such vehicle(s) in those conditions. Once driver proficiency has been recorded, carriers shall ensure that driver proficiency is maintained.

18. Unlawful operation
  - a. No motor carrier shall knowingly require or permit the operation of any school activity bus that is not in safe operating condition or is not equipped and maintained as required by any law; or knowingly require or permit any driver to drive in violation of any law.
  - b. A school activity bus damaged by an accident or other cause shall not be driven from the location where the damage occurred until it has been inspected by a qualified person who has determined that the vehicle is safe to drive.

**D. School activity bus stops**

1. Designated stops

School activity bus stops made for receiving and discharging passengers shall be approved by the school district prior to the trip. Buses shall stop at designated stops only.

2. Prohibited stops

A school activity bus stop shall not be designated at the following locations:

- a. Within 200 ft of the nearest rail of any railroad crossing or grade, except at railroad stations or on highways that parallel the railroad tracks;
- b. The left hand side of any highway; or
- c. On a divided or multiple-lane highway where passengers must cross the highway to board or after exiting the bus, unless traffic is controlled by a traffic officer or official traffic control signal. For the purposes of this subsection, a multiple-lane highway is defined as any highway having two or more lanes of travel in each direction.

3. Fire extinguisher

Every school activity bus shall be equipped with at least one fully charged fire extinguisher having at least a 10 B:C; rating. A bus designed to transport wheelchairs shall be equipped with two extinguisher, each one rated at not less than 8B:C, one to be placed in the driver's compartment and the other at the wheelchair loading door or emergency exit. Each fire extinguisher shall have been rated and labeled by one of the following test labs approved by the State Fire Marshal to test and label portable fire extinguisher for sale in the respective state.

- a. Underwriter's Laboratories, Northbrook, Illinois. All sizes and classifications.
- b. Factory Mutual Research Corporation, Norwood, Massachusetts. Sizes 10B:C, 1A 10B:C, 2A 40B:C, 3A 40B:C, and 4A 80B:C fire extinguisher filled with Halon 1211 or Halon 301.

4. Securement

Each fire extinguisher shall be securely mounted in the school activity bus in a conspicuous place or a clearly marked compartment and readily accessible.

5. Maintenance

Each fire extinguisher shall be maintained in prescribed operating condition with a current inspection certification and equipped with some means of determining if it is fully charged.

6. First aid and body fluid cleanup kit(s)

A school activity bus shall carry a readily visible, accessible and plainly marked first aid kit and a body fluid cleanup kit. The kits shall be constructed to prevent dust and moisture from reaching the contents and maintained in good condition. The kits shall be removable from the place secured. The required contents of school activity bus first aid and body fluid kits shall conform to the requirements of each respective state.

7. Emergency procedures and passenger safety training

Passengers transported in school activity buses shall receive emergency procedure and passenger safety training as prescribed by state law and/or regulations for school student-passengers transported in yellow school buses.

School Bus Danger Zone

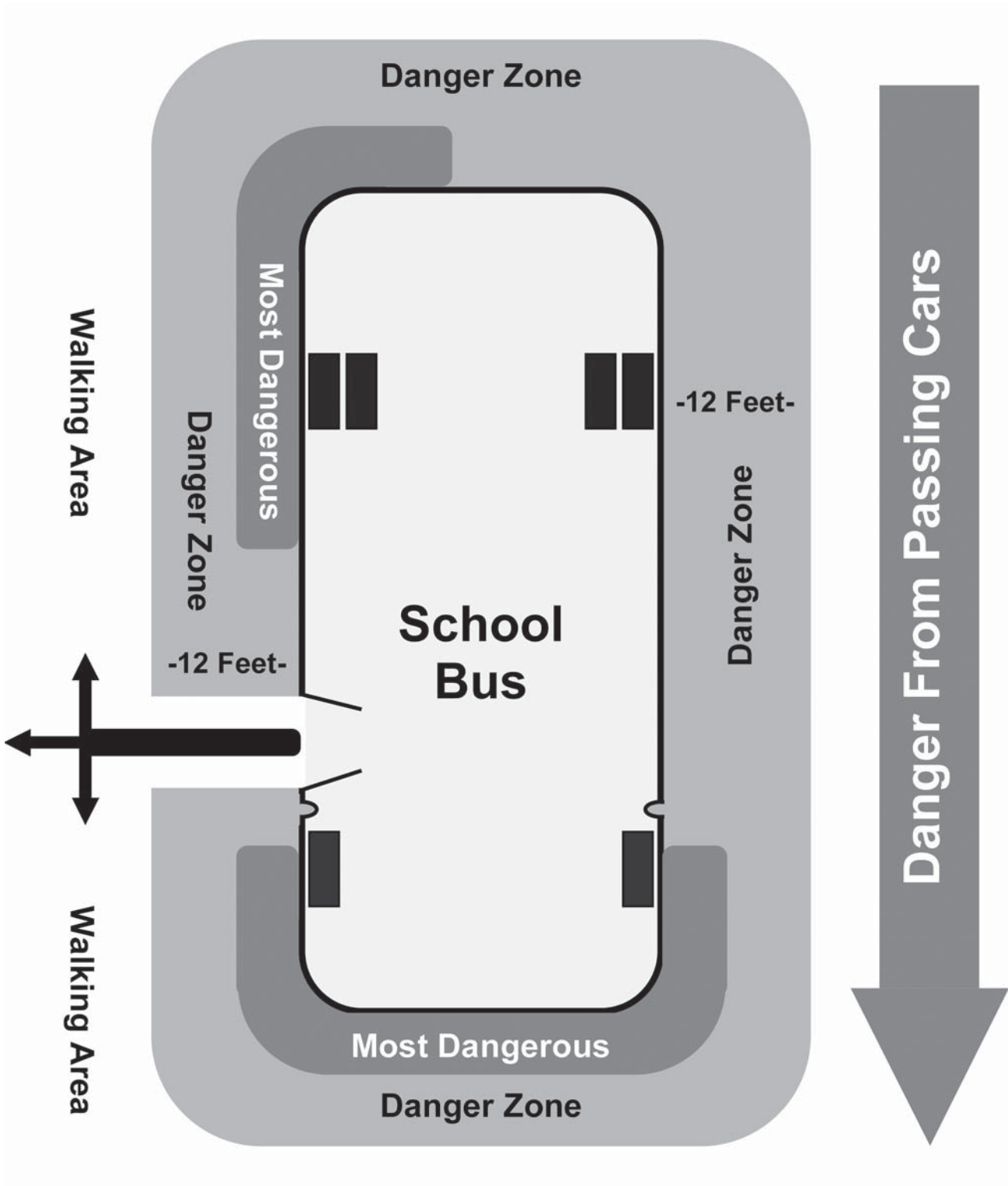

## **SAMPLE JOB DESCRIPTIONS**

### Local Student Transportation Director, Manager, Supervisor and Private Operator

- A. The local student transportation director's and private operator's specific duties should include, but are not limited to, the following activities:
1. Providing assistance in planning, budgeting and forecasting for the student transportation system.
  2. Assisting in school site selection and facility planning.
  3. Providing, when appropriate, chassis, body and related equipment procurement.
  4. Developing and implementing a plan for preventive and ongoing equipment maintenance.
  5. Recruiting, selecting, instructing, evaluating and supervising personnel.
  6. Routing and scheduling buses for safe, efficient and economical transportation service.
  7. Assisting in the development and implementation of student safety education programs.
  8. Working with administrators, teachers, transportation personnel, students, parents and various public and private agencies to improve their knowledge and the quality of the transportation system.
  9. Investigating and reporting crashes and safety-related incidents, when applicable, using the uniform school bus crash reporting criteria and standard safety incident investigation process.
  10. Investigating reported problems.
  11. Maintaining records and preparing reports, as required.
  12. Developing and supervising an ongoing evaluation plan for the student transportation system.
  13. Implementing a drug/alcohol testing program in compliance with federal regulations for persons in safety-sensitive positions and for commercially licensed drivers.
  14. Establishing and ensuring appropriate staffing levels.
  15. Recommending vehicle and equipment replacement schedules.
  16. Exhibiting effective skills in conflict-resolution and problem-solving.
- B. Minimum qualifications for the student transportation director and private operator who supervise transportation should include the following:
1. An undergraduate degree, equivalent experience or industry certification in one or more of the following fields of study is desirable:
    - a. Education;



- b. Business Administration;
  - c. Management; and
  - d. Transportation or a related field.
2. Formal instruction in student transportation management, including classroom instruction and field experience or student transportation industry certification.
  3. A basic understanding of the educational process and the corresponding role of transportation.
  4. The ability to manage personnel and resources.
  5. Basic user-level computer competency with accounting and word processing software and knowledge of web-based information systems.
  6. The ability to communicate effectively with school or Head Start Center administrators, teachers, parents, students, bus drivers, law enforcement officials, etc.
  7. Knowledge of state and federal regulations applicable to transportation of students.

**Transportation Specialist**

- A. The specific duties should include, but are not limited to, the following activities:
  1. Design and regularly update all routes and time schedules.
  2. Assign drivers to routes and extra curricular trips.
  3. Prepare routes for bidding (if applicable), including schools served and time expectations.
  4. Assign substitute drivers.
  5. Accept bus trouble calls, coordinate replacement buses and drivers.
  6. Advise building officials and parents of route changes, bus changes, late arrivals and departures.
  7. Prepare annual route schedule for distribution and notification to schools and parents.
  8. Assist in planning and presenting staff development programs and annual in-service for drivers.
  9. Assist district in designing new school service areas and boundaries, when necessary.
  10. Assist with road checking all drivers annually.
  11. Relief-drive, when necessary.
  12. Investigate school bus crashes, unsafe practices and safety-related incidents and recommend system and procedural improvements leading to improved safety of operations.

- B. Minimum qualifications should include ,but are not limited to:
1. Certified state driver instructor (if applicable).
  2. Two years of college, equivalent experience or industry certification.
  3. Basic computer skills, routing software knowledge preferred.
  4. Minimum of one year of experience in an office setting.
  5. Knowledge of district, state and federal regulations, policies and requirements pertaining to driver training and student safety.
  6. Ability to plan, schedule, evaluate and dispatch buses for all district bus routes and extra-curricular trips.
  7. Ability to recommend, train and evaluate drivers, meeting all district, state and federal requirements.
  8. Ability to recommend equipment and personnel requirements for transportation.
  9. Ability to effectively work with and direct bus drivers.
  10. Ability to maintain cooperative and effective communication with administrators, students, parents, public and other department employees.
  11. Familiarity with vehicle maintenance concepts.
  12. Ability to read and interpret road maps.
  13. Ability to communicate on the district's two-way voice communications system.

### **Dispatcher**

- A. The specific duties should include, but are not limited to, the following activities:
1. Schedule and dispatch buses and district vehicles to appropriate routes.
  2. Dispatch and coordinate bus and driver assignments for school-sponsored trips.
  3. Secure substitute drivers due to absences and review routes with substitutes, as necessary.
  4. Communicate with drivers via the transportation communications system regarding routes, emergencies and student problems.
  5. Develop and maintain records for driver assignments and vehicle scheduling and use.
  6. Receive and respond to phone calls from parents or public concerning transportation by providing information or referring call to appropriate staff members.
  7. Assist in development of bus routes, schedules and updating routes and schedules throughout the school year.
  8. Assist staff by checking roads during inclement weather.

- B. Minimum qualifications should include, but are not limited to:
1. High school graduate or equivalent.
  2. Class “B” CDL with P and S endorsements.
  3. Two years of experience in public or student transportation.
  4. Experience as a route planner or dispatcher.
  5. Effective oral and written communication skills.
  6. Ability to work effectively under pressure.
  7. Ability to make independent decisions.
  8. Ability to maintain accurate records.
  9. Ability to maintain confidentiality.
  10. Ability to operate communications system.
  11. Ability to schedule and coordinate activities.
  12. Ability to communicate and work effectively with building and department personnel.
  13. Knowledge of student transportation rules and regulations.

**Instructor/Trainer**

- A. The specific duties should include, but are not limited to, the following activities:
1. Assist with pre-interview and recommend to train.
  2. Train and retrain, as necessary, all bus drivers and bus attendants.
  3. Organize and present safety messages and programs to students.
  4. Annually evaluate, on the road, all bus drivers.
  5. Maintain all driver records and notify drivers of license or certification expirations.
  6. Recommend hiring, retraining and disciplinary action for bus drivers and bus attendants.
  7. Work with vehicle maintenance personnel on possible driver training to avoid equipment abuse.
- B. Minimum qualifications should include, but are not limited to:
1. High school graduate or equivalent.
  2. Class “B” CDL with P and S endorsements.
  3. Certified state driver instructor (if applicable).
  4. Certified first aid instructor.

5. Knowledge of state and federal laws and regulations related to bus drivers.
6. Skill in operating a bus and troubleshooting minor problems.
7. Ability to teach required subjects to obtain state school bus driver's authorization.
8. Ability to instruct CDL requirements.
9. Ability to provide effective instruction in soft skills categories (i.e. confidentiality and intervention strategies).
10. Ability to effectively communicate with staff, peers and community.
11. Ability to establish and maintain effective working relationships.
12. Evidence of effective oral and written communications.
13. Proficiency in basic computer and presentation skills.

### **Routing Specialist**

- A. The specific duties should include, but are not limited to, the following activities:
  1. Coordinate the development and maintenance of bus stops, runs, routes and schedules consistent with district policies and state requirements.
  2. Gather criteria necessary for the development of the school district's school boundaries, street address ranges, speed limits, one-way streets, traffic hazards and hazardous walkway areas.
  3. Review all bus route change requests.
  4. Communicate with drivers and dispatchers to resolve problems with routes.
  5. Communicate with parents, teachers, principals and others regarding the transportation of students.
  6. Generate transportation-related reports, as required by the Transportation Director.
  7. Evaluate existing hazardous walkway areas and determine route revisions, making recommendations to appropriate individuals.
- B. Minimum qualifications should include, but are not limited to:
  1. High school graduate or equivalent.
  2. Three years of computer routing experience.
  3. Knowledge of operating procedures for student transportation.
  4. Knowledge of routing procedures and methods.
  5. Ability to analyze and make recommendations regarding bus routing activities.
  6. Ability to work under pressure.

7. Ability to organize, set priorities and meet deadlines.
8. Ability to maintain accurate records and generate computerized reports.
9. Ability to establish and maintain effective working relationships with a variety of people.
10. Ability to establish a customer service environment.
11. Working knowledge of computer routing systems and boundary analysis software applications.

## **Secretary**

- A. The specific duties should include, but are not limited to, the following activities:
  1. Develop and maintain filing and record-keeping systems, both physical and electronic.
  2. Finalize correspondence and reports prepared by others. Prepare correspondence, reports and other documents, as directed. Perform data entry of pertinent information.
  3. Design, format and prepare forms and other documents.
  4. Ensure that documents are free from typographical errors, misspellings, omissions, logical inconsistencies and grammatical errors.
  5. Ensure that sufficient levels of office supplies are maintained.
  6. Arrange for meeting space, send notices and track responses, ensure appropriate refreshments are available and rooms and equipment are properly set up.
  7. Use standard office equipment.
  8. Coordinate activities with other clerical staff, departments and outside agencies.
  9. Report employees' hours of work, sick leave, vacation and other leaves to payroll, per district policy and procedures.
  10. Maintain permanent employee records, including payroll, evaluations and leaves, per district policy and procedures.
  11. Answer phones while maintaining professional demeanor and answering queries or redirecting caller to the appropriate personnel.
  12. Facilitate purchase of equipment by obtaining quotes, and preparing purchase orders. (This often is the duty of the Purchasing Agent.)
  13. Ensure that all financial transactions are properly recorded, totaled, balanced and reconciled with budget. (This often is the duty of the Bookkeeper.)
- B. Minimum qualifications should include, but are not limited to:
  1. High school graduate or equivalent.
  2. Computer experience in word processing, database, spreadsheet and desktop publishing.
  3. Two years' secretarial experience in an office setting.

4. Ability to create and maintain a filing system.
5. Ability to enter data.
6. Ability to create forms, documents, and pamphlets, using desktop publishing.
7. Ability to maintain good telephone skills.
8. Good organizational and time management skills.
9. Excellent oral and written skills.
10. Ability to handle changing priorities.
11. Knowledge of payroll practices and procedures.
12. Knowledge of general accounting and purchasing procedures.
13. Ability to work effectively under high stress situations.
14. Ability to maintain confidentiality,

### **Bookkeeper**

- A. The specific duties should include, but are not limited to, the following activities:
  1. Develop and maintain records of budget data, both physical and electronic.
  2. Prepare special reports, as required by the Transportation Director.
  3. Prepare purchase orders and maintain records.
  4. Ensure that all financial transactions are properly recorded, totaled, balanced and reconciled with budgeted amounts.
  5. Invoice departments, schools and other agencies for transportation services performed.
  6. Obtain quotes and prepare purchase orders for buses, supplies, office and shop equipment.
  7. Maintain inventory of all buses and district vehicles, including VIN and license numbers, model, chassis, seat and vehicle-rated capacity, wheelchairs and occupant restraint systems.
  8. Remove and add vehicles for insurance purposes.
  9. Assist with insurance claims and warranty work.
  10. Assist with development of annual budget.
  11. Assist with answering phones while maintaining professional demeanor and answering queries or redirecting caller to the appropriate personnel.
  12. Use copiers and other office equipment.

- B. Minimum qualifications should include, but are not limited to:
1. High school graduate or equivalent.
  2. Experience with word processing, spreadsheets and database.
  3. Experience as bookkeeper in an office setting.
  4. Ability to organize tasks and documents in a logical manner.
  5. Ability to complete basic formulas and operations, such as sorting and extracting.
  6. Ability to operate a ten-key calculator.
  7. Ability to use various types of office equipment.
  8. Ability to reconcile checking accounts or bank statements.
  9. Ability to maintain good telephone skills.
  10. Ability to enter data.
  11. Knowledge of general mathematics applications.
  12. Knowledge of general accounting procedures.
  13. Knowledge of purchasing regulations.
  14. Knowledge of bidding and/or low-quote purchase of school buses.
  15. Ability to maintain confidentiality.

**Bus Driver**

- A. The specific duties should include, but are not limited to, the following activities:
1. Report defective school bus equipment and accessories, including but not limited to, fire extinguishers, highway warning kits, first aid and body fluid cleanup kits, snow chains, sanders, etc., and when necessary install, service or replace defective equipment.
  2. Perform required operational and safety inspections of the school bus and all related equipment.
  3. Ability to clean and service the school bus to include interior cleaning and exterior bus washing, installation of fuel, oil and other fluids, as directed.
  4. Operate all hand and foot controls installed in a school bus, as required.
  5. Perform basic first aid, as appropriate, which may include CPR.
  6. Work effectively with a group of students of different grade levels, abilities or program placement.
  7. Complete legibly and accurately forms, records, reports and other documentation/data-logging activities, as required by state or district policy.

8. Be punctual.
  9. Dress appropriately and wear proper foot protection.
  10. Manage passengers in the school bus.
  11. Report unsafe acts or conditions that require the attention of any person other than the driver.
  12. Successfully complete school bus driver training programs and courses established by the state or district.
- B. Minimum qualifications should include, but are not limited to:
1. High school graduate or equivalent.
  2. Hold and maintain a class license with all applicable endorsement for the type of vehicle being driven.
  3. Excellent driving record.
  4. Physical ability to drive and perform all duties related to school bus operations.
  5. Ability to relate effectively with parents, staff and public in a multicultural and multiracial community.
  6. Sufficient command of local language to communicate with students, parents, district staff members and other concerned individuals regarding all aspects of their job-related activities.
  7. Ability to pass a criminal history background check.
  8. Ability to pass a state or DOT medical examination.
  9. Ability to pass a federally mandated drug/alcohol screen.

**Bus Attendant (Monitor or Aide)**

- A. The specific duties should include, but are not limited to, the following activities:
1. Assist the school bus driver.
  2. Assist students to safely embark and disembark from a school bus.
  3. Ensure a safe trip for every student.
  4. Make sure that students get off at the correct bus stop.
  5. Help implement safety standards on board the bus.
  6. When applicable, assist with loading/unloading and securing of assistive devices and safety restraints.
  7. Assist driver with student management.



- B. Minimum qualifications should include, but are not limited to:
1. High school graduate or equivalent.
  2. Ability to work with all students.
  3. Ability to physically move wheelchairs onto wheelchair ramp and into the bus.
  4. Ability to physically remove students from a disabled bus.
  5. Ability to get along with co-workers, parents, students and other staff.
  6. Ability to interact with students.
  7. Ability to follow directions.
  8. Ability to communicate with staff.

**Vehicle Maintenance Supervisor, Foreman and Manager**

- A. The specific duties should include, but are not limited to, the following activities:
1. Supervise and work with technicians in diagnosing malfunctions on vehicles.
  2. Supervise and work with technicians to overhaul and rebuild engines, transmissions and other vehicle components.
  3. Purchase parts, materials and supplies required for proper maintenance of district vehicles, related equipment and shop facilities, per district procedures.
  4. Coordinate maintenance of buses with dispatchers to ensure the bus fleet is ready to meet operational requirements.
  5. Recommend and assist with short- and long-term bus purchase planning.
  6. Oversee record-keeping, evaluate reports for work assignments, inspect work, as needed, review time and parts used for repair and maintain inventory at required levels.
  7. Evaluate needs and recommend purchase of new or replacement shop equipment, machines, tools and related items.
  8. Assist in evaluating bids and recommend awards for jobs performed by outside vendors.
  9. Assume responsibility for cleanliness, upkeep and organization of shop building, as well as safety, security, equipment and parts.
  10. Assume responsibility for hazardous material disposal, following all governmental regulations and required reporting and record-keeping.
  11. Assume responsibility for evaluating all shop personnel.
  12. Prepare and maintain preventive maintenance schedules.

- B. Minimum qualifications should include, but are not limited to:
1. High school graduate or equivalent.
  2. Minimum of five years of experience in automotive technician field.
  3. One year of full-time experience as a journeyman technician in a truck or bus maintenance facility.
  4. One year of full-time experience at the supervisory level in an automotive maintenance facility.
  5. Class “B” CDL with P and S endorsements.
  6. Knowledgeable user of computer-based business and fleet management software.
  7. Ability to direct and coordinate employees.
  8. Ability to communicate with staff.
  9. Ability to understand job functions in relationship to school district requirements.
  10. Ability to work under pressure.
  11. Ability to teach/instruct.
  12. Ability to maintain and analyze vehicle records.
  13. Ability to use and understand diagnostic equipment.

### **Journeyman Technician**

- A. The specific duties should include, but are not limited to, the following activities:
1. Diagnose and repair mechanical, electrical and engine defects in buses and other automotive equipment.
  2. Overhaul and rebuild engines, transmissions, differentials, brake systems and other major components by repair and replacement of parts.
  3. Repair and rebuild generators, alternators and all other electrical components utilizing testing devices and machine equipment, as required.
  4. Perform general tune-ups, utilizing diagnostic equipment.
  5. Make roadside repairs, as required.
  6. Repair and replace seats, glass, sheet metal, latches and other body components and assemblies.
  7. Change oil and filters; install antifreeze and snow chains; repair tires; adjust brakes; lubricate chassis, wheel bearings and other assemblies, as required.
  8. Perform all required preventive maintenance and regular bus safety inspections.

9. Operate battery chargers, valve re-facing and reseating machines, compression gauges, torque wrenches, welding equipment, grinders, reamers, timing lamps, hoists, jacks, presses, headlight adjustment machines, air wrenches, small lathes, spark plug testers and other equipment for performing repair and maintenance of motor vehicles.
  10. Assist in cleaning and organizing the shop, parts room and other maintenance facilities.
  11. Complete vehicle maintenance forms and records.
- B. Minimum qualifications should include, but are not limited to:
1. High school graduate or equivalent.
  2. Class "B" CDL with P and S endorsements.
  3. Completion of a recognized apprenticeship as an automotive technician, full journeyman status as an automotive technician or a minimum of four years' applicable work experience of any equivalent combination of experience and training.
  4. Experience in repair and maintenance of heavy duty and diesel vehicles and special vehicular equipment.
  5. Ability to identify, diagnose and repair vehicle malfunctions.
  6. Ability to communicate with staff, peers and students.
  7. Ability to understand job functions in relationship to school district needs.
  8. Ability to work under pressure.
  9. Ability to maintain accurate bus repair and other records.
  10. Be in good physical condition.

### **Assistant Technician**

- A. The specific duties should include, but are not limited to, the following activities:
1. Assist journeyman technicians in overhaul, rebuilding and replacing major assemblies and components.
  2. Lubricate buses and other automotive equipment to include chassis lube, oil and filter changes, gearbox fill or drain and flush, wheel bearing pack and all other lubricating and air cleaner service procedures, as required.
  3. Verify operational safety of equipment and devices, such as brakes, clutch, lamps, mirrors, glass, fire extinguishers, first aid kits, highway warning kits, horn, warning lamps and buzzers, emergency exits, wipers, signs, tires, etc.
  4. Change and repair tires, perform complete battery service and brake adjustments.
  5. Install antifreeze; service cooling systems; inspect and replace hoses, caps valves etc.
  6. Make minor repairs by replacing lamps, spark plugs, ignition parts, patches and switches, as required.

7. Operate lubrication equipment, hoist, compressor, battery charger, diagnostic equipment, headlight adjustment machine, alignment board, spark plug tester, drills, presses, air wrenches and other tools and equipment, as required in the performance of assigned duties.
  8. Drive service truck for roadside service, as required.
  9. Assist in cleaning and organizing the shop, parts room and other maintenance facilities.
- B. Minimum qualifications should include, but are not limited to:
1. High school graduate or equivalent.
  2. Class "B" CDL with P and S endorsements.
  3. Minimum two years of general experience in service station-type automotive maintenance, plus one year related experience on buses, trucks or other heavy duty vehicular equipment.
  4. Possess a basic set of auto technician hand tools and storage cabinet, if required.
  5. Be in good physical condition.
  6. Ability to work under pressure.
  7. Able to follow directions.
  8. Ability to communicate with staff.

## **HIRING NEW EMPLOYEES**

Employment procedures should be clearly stated in writing and followed by all parties involved in the procedures. There should be no discrimination in the advertisement of a job opening, in the application review process or in the interview. All applicants must be treated equally and interviewed/not interviewed or hired/not hired based on objective and measurable criteria. It is illegal to make any inquiry or keep any record of race, creed, color, national origin, age, sex, marital status or disability before, during or after employment for the purpose of discriminating on these grounds.

The following are essential steps to be incorporated in screening and hiring procedures:

1. Advertising
  - a. Contact the Personnel Department/Human Resources Office for possible applications on file. (Some offices have a phone jobline available for posting job openings.) Advertising by word of mouth, newspapers, employment office, school lunch menus and notices in retail stores or local fire departments are also good methods to get word out to the community regarding job openings.
  - b. Provide written procedures, job requirements and duties to applicants. Pre-employment screening requirements (e.g., criminal background checks, driving record checks, drug screening, etc.) should be listed in each packet of information provided to potential applicants.

## 2. Applicant screening

- a. Check application forms for completeness. Contact applicants as soon as possible to obtain any information that was omitted from the original application documents. One method is to formulate a check-off list to verify the completeness of the applications and that the applicants meet all requirements for the position. A point system or some other grading criteria should be developed that will result in an objectively obtained score. It is advisable for the Personnel Department/ Human Resources Office to keep these screening sheets on file, should the district be challenged by an applicant that feels he/she has been discriminated against. The successful applicants should be scheduled for an interview when screening and background checks are completed. This may be done by phone or letter.
- b. Conduct background checks, as may be required. Advise applicants of procedures for fingerprinting for criminal records checks, authorization for driving records check, drug/alcohol screening and any other background checks that are required. Obtain written authorization for any such checks. If a CDL is required prior to employment, a copy of the applicant's current license and physical examination form may be requested at this stage in the procedure.
- c. Contact personal references and previous employers listed on application forms. It is very important to check references; however, because personnel issues are confidential, it is very important to receive written permission from the applicant to allow the former employer(s) to release all information, including any available drug and alcohol test results. If you do not have this release, the only information you will usually obtain is date(s) of employment and position held. One question they may answer is this: "Would you rehire?" If the answer is "No," you may want to more thoroughly evaluate the applicant.
- d. Determine amount of pre-service training required for applicants to fulfill job requirements.

## 3. Interview

### a. Planning the interview

Interviews should be held in a pre-determined, pre-appointed setting. The interview team should be selected, seating arrangements determined and questions prepared before the interview begins. Applicants should not have to wait. It is very important to plan the number of questions to be asked and about how long the interview should take. Allow time in the schedule for the interview team to exchange any thoughts or concerns about the applicants while information is fresh.

### b. Interview questions

Questions should be open-ended. Try to avoid asking questions that can be answered with a "yes" or "no." The number of questions depends on the kind of information the interview team wishes to gather and evaluate. Always allow the applicant to ask the team any questions he/she may have. "Look for" answers, pre-determined by human resources staff and/or the interview team, must be resolved before the interview. The answer(s) are what the team is "looking for" when the applicant is interviewed. Each member of the team would then grade the answer he/she hears on a pre-designed sliding scale.

Do not ask illegal questions. The perception by the candidate could be that he or she was not picked because of the answer of an illegal/personal question.

The interview team should meet in advance to determine assignments and to stress that all candidates for the position must be treated equally and asked the same questions, preferably by the same interview team member.

c. Concluding interview activities

After all interviews are completed, interview team members should grade their interview sheets. (These must be kept in the event the district may be challenged about the decision by an unsuccessful applicant at a later date.) Applicants' composite scores should be tallied and recommendations prepared.

4. Recommend hiring

Applicants for all positions must be screened, and only those applicants that qualify in terms of education, job skills and experience should be recommended for final consideration.

5. Hire

Hiring an employee is a process with many steps that usually begins with the need to fill an open or new position. Hiring, the final step, should follow a clearly established written procedure, which often must be ratified by the governing authority of the agency involved.

**APPENDIX E**

**Transportation for  
Students with  
Disabilities and  
Special Health Care  
Needs**





**APPENDIX E**

**SPECIAL EDUCATION DEPARTMENT FORMS**

**Sample Form 1**

**CONSENT FOR DISCLOSURE OF MEDICAL INFORMATION AND RECORDS**

TO: \_\_\_\_\_  
(Physician's Name and Address)

I, \_\_\_\_\_, the (parent/guardian) of \_\_\_\_\_ (Student) consent and authorize you to disclose and provide to the \_\_\_\_\_ (School District), its nursing and other necessary service providers, upon the school district's request, any information or records which you have concerning the diagnosis, evaluations, tests, medical problems or conditions, medications, or treatments of my child or ward named above.

I hereby waive any and all privileges which I or my child or ward might have with respect to disclosure of the above information and records to the school district, including the doctor-patient privilege, psychologist-client privilege, and social worker-client privilege.

Signature of Parent or Guardian: \_\_\_\_\_

Print Name: \_\_\_\_\_ Dated: \_\_\_\_\_

PLEASE RETURN TO: \_\_\_\_\_

\_\_\_\_\_

**REQUEST FOR MEDICAL VERIFICATION OF HEALTH STATUS AND NEEDS**

**Sample Form 2**

SCHOOL DISTRICT: \_\_\_\_\_  
(Address)

NAME: \_\_\_\_\_ BIRTH DATE: \_\_\_\_\_

ADDRESS: \_\_\_\_\_ PHONE: \_\_\_\_\_

PARENT/GUARDIAN NAME: \_\_\_\_\_ PHONE: \_\_\_\_\_

ADDRESS (IF DIFFERENT): \_\_\_\_\_

PHYSICIAN: \_\_\_\_\_

NOTE TO PHYSICIAN: Should you have any questions regarding this request, please contact:

\_\_\_\_\_  
PHONE: \_\_\_\_\_

**A. VERIFICATION OF MEDICAL, HEALTH AND BEHAVIOR STATUS.**

1. Briefly describe the current medical, health and behavioral status.
2. Identify any medical conditions not addressed above.
3. Identify any health concerns that are not addressed above.
4. Identify any behavioral concerns that are not addressed above.

**B. PARTICIPATION IN THE SCHOOL DAY PROGRAM**

1. Briefly describe the staff supervision and interventions necessary for the student to safely participate in the normal school day program, given the student's health and medical status.
2. Identify the training required for all staff, including bus attendants and drivers, to provide the supervision and interventions addressed above.
3. Identify any additional restrictions or modifications in school activities or medical care that would be necessary for the student to safely participate in the school day program.
4. Identify any additional special equipment, aids, restraints, or mobility assistance needed for the student to safely participate in the school day program.

## MEDICAL PROCEDURE AUTHORIZATION

### Sample Form 3

I delegate and authorize the staff of the \_\_\_\_\_ School District to perform for \_\_\_\_\_ (pupil) the acts, tasks and functions indicated on the Request for Medical Verification of Health Status and Needs, dated \_\_\_\_\_, which I previously provided to the district. This authorization is subject to the condition that district staff assigned to perform these activities have been provided the required training, as specified in the above request.

I have reviewed the attached procedures for \_\_\_\_\_ (procedure) that will be utilized, and I approve them, subject to any specific modifications necessary for this student, which I have noted on the procedures.

I agree to supervise the performance of these activities and procedures by being continuously available through direct communications with district staff performing them and by regularly reviewing the student's health/medical status and needs, as well as the procedures being utilized by the staff.

\_\_\_\_\_  
Signature of Physician

\_\_\_\_\_  
Date

**STUDENT TRANSPORTATION CARD-STUDENTS WITH DISABILITIES**

**Sample Form 4**

Student's Name: \_\_\_\_\_ Date: \_\_\_\_\_

Address: \_\_\_\_\_ Phone: \_\_\_\_\_

Father's Work Phone: \_\_\_\_\_ Mother's Work Phone: \_\_\_\_\_

Emergency Phone: \_\_\_\_\_

Please check appropriate type of transportation for your child:

- |  |  |
|--|--|
| <input type="checkbox"/> Walks to bus unassisted   | <input type="checkbox"/> Walks to bus, but needs assist. |
| <input type="checkbox"/> Requires a car seat       | <input type="checkbox"/> Wheelchair                      |
| <input type="checkbox"/> Needs to be carried       | <input type="checkbox"/> Requires Special Restraint      |
| <input type="checkbox"/> Booster seat              | <input type="checkbox"/> Positioning Devices             |
| <input type="checkbox"/> Special Equipment         | <input type="checkbox"/> Requires Attendant              |
| <input type="checkbox"/> Needs to be met at school | <input type="checkbox"/> Other (Specify) _____           |
- On return/home, needs to be met at Bus Stop

Names and Addresses of persons near student's residence who have consented to care for the student if the parents are not available:

Name: \_\_\_\_\_ Address: \_\_\_\_\_ Phone: \_\_\_\_\_

Name: \_\_\_\_\_ Address: \_\_\_\_\_ Phone: \_\_\_\_\_

Name: \_\_\_\_\_ Address: \_\_\_\_\_ Phone: \_\_\_\_\_

Please check if any of the following applies to your child:

- |                                      |   |
|--------------------------------------|---|
| <input type="checkbox"/> Asthma      | <input type="checkbox"/> Heart Disease                |
| <input type="checkbox"/> Diabetes    | <input type="checkbox"/> Blind                        |
| <input type="checkbox"/> Deaf        | <input type="checkbox"/> Chronic Respiratory Problems |
| <input type="checkbox"/> Non-Verbal  | <input type="checkbox"/> Bee Sting Reaction           |
| <input type="checkbox"/> Hemophiliac | <input type="checkbox"/> Allergies—to what? _____     |

Seizures:

How long does seizure last? \_\_\_\_\_

How often does it occur? \_\_\_\_\_

Action needed, if any: \_\_\_\_\_

Is your child on medication?       Yes       No  
If yes, what medication, what dosage, and when given? \_\_\_\_\_

Family Doctor: \_\_\_\_\_

Address: \_\_\_\_\_

Doctor's Phone Number: \_\_\_\_\_ Family Designated Hospital: \_\_\_\_\_

**Parental Contact:** If possible and practical, in the event of major emergency, parent contact will be made.

**Parental Approval:** If, in the opinion of the driver, a major emergency exists, the parent(s) have agreed in writing and will assume the cost of:

- |  |                          |     |                          |    |
|--|--------------------------|-----|--------------------------|----|
| 1. Contacting the family doctor        | <input type="checkbox"/> | Yes | <input type="checkbox"/> | No |
| 2. Contacting any doctor available     | <input type="checkbox"/> | Yes | <input type="checkbox"/> | No |
| 3. Contacting rescue squad             | <input type="checkbox"/> | Yes | <input type="checkbox"/> | No |
| 4. Transporting to designated hospital | <input type="checkbox"/> | Yes | <input type="checkbox"/> | No |

Other Helpful Information: \_\_\_\_\_

\_\_\_\_\_  
\_\_\_\_\_

As parent or guardian, I agree to one or more of the above procedures as indicated and agree that this information may be shared with my child's transporter.

CONFIDENTIALITY WILL BE MAINTAINED.

\_\_\_\_\_  
Parent's or Guardian's Signature

\_\_\_\_\_  
Date

**DO NOT WRITE BELOW THIS LINE**

Bus Company: \_\_\_\_\_

Bus No.: \_\_\_\_\_ Telephone: \_\_\_\_\_

Special Instructions for Driver: \_\_\_\_\_

\_\_\_\_\_

**TRANSPORTATION SERVICE REQUIREMENTS FOR  
PASSENGERS WITH HEALTH CONCERNS**

**Sample Form 5**

SCHOOL DISTRICT: \_\_\_\_\_

ADDRESS: \_\_\_\_\_

DATE: \_\_\_\_\_ ASSIGNED SCHOOL: \_\_\_\_\_

GRADE LEVEL: \_\_\_\_\_ SPECIFIC PROGRAM: \_\_\_\_\_

HOME SCHOOL: \_\_\_\_\_ NAME OF STUDENT: \_\_\_\_\_

BIRTH DATE: \_\_\_\_\_ STUDENT I.D. #: \_\_\_\_\_

HOME ADDRESS: \_\_\_\_\_ APT. NO.: \_\_\_\_\_ ZIP: \_\_\_\_\_

HOME PHONE: \_\_\_\_\_

A.M. PICK-UP LOCATION: \_\_\_\_\_ PHONE: \_\_\_\_\_

P.M. DROP-OFF LOCATION: \_\_\_\_\_ PHONE: \_\_\_\_\_

PARENT(S) NAME: \_\_\_\_\_

FATHER'S WORK PHONE: \_\_\_\_\_ MOTHER'S WORK PHONE: \_\_\_\_\_

**EMERGENCY / ALTERNATE CONTACT:**

Name: \_\_\_\_\_ Phone: \_\_\_\_\_

Address: \_\_\_\_\_

Name: \_\_\_\_\_ Phone: \_\_\_\_\_

Address: \_\_\_\_\_

**EMERGENCY MEDICAL INFORMATION:**

Student's Doctor: \_\_\_\_\_ Phone: \_\_\_\_\_

Hospital Preference: \_\_\_\_\_ Address: \_\_\_\_\_

ALLERGIES: \_\_\_\_\_

MEDICATION(S) STUDENT IS TAKING: \_\_\_\_\_

DOSAGE: \_\_\_\_\_

SPECIAL INSTRUCTIONS FOR ATTENDING PHYSICIAN(S): \_\_\_\_\_

SPECIFIC INSTRUCTIONS IF PARENT(S) ARE NOT AT HOME: \_\_\_\_\_

LEVEL OF SUPERVISION REQUIRED (Attach Medical Procedure Authorization and Procedures): \_\_\_\_\_

REQUIRED TRAINING FOR SUPERVISION: \_\_\_\_\_

INTERVENTIONS REQUIRED (Attach Medical Procedure Authorization and Procedures): \_\_\_\_\_

REQUIRED TRAINING FOR INTERVENTIONS: \_\_\_\_\_

OTHER ADDITIONAL RESTRICTIONS OR MODIFICATIONS NECESSARY TO TRANSPORT STUDENT: \_\_\_\_\_

DISABILITY CONDITIONS AFFECTING TRANSPORTATION: \_\_\_\_\_

SPECIAL EQUIPMENT, AIDS OR MOBILITY REQUIRED: \_\_\_\_\_

ADDITIONAL COMMENTS/INSTRUCTIONS: \_\_\_\_\_

\_\_\_\_\_

\_\_\_\_\_

\_\_\_\_\_

**PROCEDURE IF CHANGE IN SERVICE IS NECESSARY:** If there are any changes in the student's health, medical or behavior status which the parent(s), physician, transportation or other school staff believe may merit changes in staffing, precautions to be taken, interventions, restraints, or any other procedure noted above, the concerned party shall immediately contact: \_\_\_\_\_ (phone: \_\_\_\_\_ ) who will, in turn, initiate the process to evaluate and recommend necessary changes with the involvement of parents(s), physician, school and transportation staff.

### **APPROVAL OF TRANSPORTATION SERVICE REQUIREMENTS**

Each of the following persons has participated in the development of these transportation service requirements and by signing below approves them for implementation.

Dated: \_\_\_\_\_ Signature of Parent / Guardian: \_\_\_\_\_

Print Name: \_\_\_\_\_

Dated: \_\_\_\_\_ Signature of School District Representative: \_\_\_\_\_

Title: \_\_\_\_\_

Dated: \_\_\_\_\_ Signature of Transportation Staff Representative: \_\_\_\_\_

Title: \_\_\_\_\_

Dated: \_\_\_\_\_ \*Signature of Private Contracted Transporter: \_\_\_\_\_

Title: \_\_\_\_\_

Dated: \_\_\_\_\_ \*Signature of School Nurse: \_\_\_\_\_

Dated: \_\_\_\_\_ \*Signature of Physician: \_\_\_\_\_

\*If an appropriate signature under the circumstances.

cc: All transportation service providers.



# TRANSPORTATION CHECKLIST

## Sample Form 6

Student Name: \_\_\_\_\_ ID: \_\_\_\_\_

School: \_\_\_\_\_ Grade: \_\_\_\_\_ Date: \_\_\_\_\_

	Yes	No	<b>Special Education Services</b>
--	-----	----	-----------------------------------

- |    |                          |                          |   |
|----|--------------------------|--------------------------|---|
| 1. | <input type="checkbox"/> | <input type="checkbox"/> | Will services be provided at the school of residence?   |
| 2. | <input type="checkbox"/> | <input type="checkbox"/> | Is the student eligible for extended school year services that may be located at a school other than the school of residence? |
| 3. | <input type="checkbox"/> | <input type="checkbox"/> | Will the student's IEP address goals and objectives related to transportation access?   |

### **Transportation Concerns**

- |    |                          |                          |  |
|----|--------------------------|--------------------------|--|
| 4. | <input type="checkbox"/> | <input type="checkbox"/> | Have parents been informed of their role and responsibility in transportation of their child?                              |
| 5. | <input type="checkbox"/> | <input type="checkbox"/> | Does the student require adult supervision at the bus stop? If yes, parent or designee must meet the child at the stop.    |
| 6. | <input type="checkbox"/> | <input type="checkbox"/> | Are there circumstances that affect the location of the pick-up and/or drop-off locations? If yes, specify: _____<br>_____ |
| 7. | <input type="checkbox"/> | <input type="checkbox"/> | Are there specific types of assistance that the bus driver or attendant must provide? If yes, specify: _____<br>_____      |

List any other characteristics, behaviors or needs (such as seating concerns) that may impact transportation. \_\_\_\_\_  
\_\_\_\_\_

- |    |                          |                          |   |
|----|--------------------------|--------------------------|---|
| 8. | <input type="checkbox"/> | <input type="checkbox"/> | If it is in the best interest of the student to provide atypical transportation services, (a vehicle other than a bus) please specify:<br>_____ |
|----|--------------------------|--------------------------|---|

## Medical Concerns

To be completed in conjunction with the Nurse/Physician Assessment and/or Behavior Intervention Plan (BIP). Attach supporting documentation:

9.   Does the student have a physical disability that is life-threatening and requires monitoring, interpretation or intervention, as determined by the site or special education itinerant nurse?
10.   Is the student affected by a medical condition that limits the length of time he or she is able to ride on a bus? (Attach assessment and explain.) \_\_\_\_\_  
\_\_\_\_\_
11.   Does the student use technology or assistive devices such as a tube, a helmet, or a ventilator, or require oxygen frequent suctioning? Circle which, and attach assessment.
12.   Does the student experience uncontrolled seizures, severe hypotonia causing potentially obstructed airway or apnea? Circle which, and attach assessment.
13.   Does the student use a walker, manual wheelchair, power wheelchair? Circle which, and indicate wheelchair width; if applicable;
14.   Is the student affected by a chronic medical condition that limits his or her ability to walk to and from school? If yes, explain: \_\_\_\_  
\_\_\_\_\_

**TRANSPORTING OXYGEN IN SCHOOL BUSES**

**Administrative Tracking Form**

**Sample Form 7**

Student Name: \_\_\_\_\_

Grade: \_\_\_\_\_

Program: \_\_\_\_\_

Nurse/Practitioner Release on File:  Yes  No

Address: \_\_\_\_\_

\_\_\_\_\_

Telephone: \_\_\_\_\_

Bus/Track #: \_\_\_\_\_

Type of Oxygen Transported:

Medical e-grade (less than 30 liquid cubic feet)

Liquid

Transported Only

Administered During Transport

Secured to 5X Weight

Method of Securement (explain): \_\_\_\_\_

\_\_\_\_\_

\_\_\_\_\_

\_\_\_\_\_

Driver/Attendant Training Completed, as Necessary: \_\_\_\_\_

Signature: \_\_\_\_\_

Date: \_\_\_\_\_

## **PROCEDURE FOR LIFTING PASSENGERS**

**PURPOSE:** The purpose of proper lifting techniques is to move the passenger without injury to yourself or the passenger.

### **BASIC RULES**

1. Tell the passenger what you are going to do.
2. Estimate the weight of the passenger. **NEVER ATTEMPT TO CARRY ALONE A STUDENT WHO WEIGHS MORE THAN HALF YOUR OWN WEIGHT** unless the student is in immediate danger and no assistance is available.
3. Always attempt to get help if you have any doubts about your ability to lift the student. If there is only a driver in a bus, and the necessity for an emergency evacuation develops, some districts suggest that the driver activate the alternating red lights, as the evacuation procedure is truly an **UNLOADING PROCEDURE**. Such action can draw attention from motorists that you need assistance. District policy should determine if this procedure is appropriate.
4. Be sure your path is **CLEAR**.
5. Stand with both feet firmly planted about shoulder-width apart for good balance.
6. Always bend from knees, not from back, so that you use your thigh muscles and buttock muscles rather than your back muscles to do the lifting.
7. When lifting and carrying, keep the student as close to your own body as possible.
8. Shift the position of your feet to move. **DO NOT TWIST YOUR BODY**. Take small steps to turn.

### **SINGLE-PERSON LIFT**

1. Follow the basic rules 1-8. Most strains, fatigue and back injuries caused by lifting are due to using the **WRONG** muscles. Use your **STRONG LEG AND BUTTOCK MUSCLES** (by bending at the knees and hips), **NOT YOUR BACK MUSCLES**. Maintain the normal curves of the spine when lifting and avoid rounding of the upper back.
2. Keep equal weight on both feet, and lower yourself to the level of the student by bending your knees and hips before lifting.
3. Once in position, put one arm around the student's upper back and the other under both knees.

## **TWO-PERSON LIFT**

1. Follow Basic Rules 1-8.
2. TO LIFT FROM A WHEELCHAIR:
  - A. Position the wheelchair as close to your destination as possible. In an emergency situation, to save time and congestion, leave the chair where it is strapped and blanket-pull or carry the student to the appropriate exit location.
  - B. One person stands to the side in front; the other person stands in back.
  - C. The person in front removes the arm rest (if detachable) and folds up the footrest.
  - D. The person in back removes or cuts the seat belt and any other positioning device.
  - E. The person in front, bending from knees and hips, lowers himself or herself to place one arm under the student's knees and the other under the student's thighs.
  - F. The person in back places his or her arms under student's armpits, reaching forward to grasp both student's wrists firmly (right hand to student's right wrist; left hand to left wrist).
  - G. Lift together on the count of 3. (REMEMBER TO USE YOUR LEGS AND BUTTOCK MUSCLES TO LIFT.)
  - H. Walk to the area where the student is to be placed and lowered on the count of 3, bending from the knees and hips.
3. TO LIFT FROM A BUS SEAT:

Use the same procedure as above, but first, SLIDE THE STUDENT TO THE EDGE OF THE BUS SEAT NEAR THE AISLE.

## **BLANKET LIFT**

1. Use a blanket that has been approved for this purpose by its manufacturer.
2. Fold the blanket in half, place it on the floor as close to the student as possible.
3. Follow lifting rules 1-8, and lower the student to the blanket.
4. ONE PERSON LIFT: Place the student's head toward the direction of the exit, lift the blanket from the head and slide the student to safety.

## Characteristics of Disabilities as Defined by IDEA

Definitions of disability terms. The terms used in this definition are defined as follows:

- A. *Autism* means:
1. A developmental disability significantly affecting verbal and nonverbal communication and social interaction, generally evident before age 3, that adversely affects a child's educational performance. Other characteristics often associated with autism are engagement in repetitive activities and stereotyped movements, resistance to environmental change or change in daily routines, and unusual responses to sensory experiences. The term does not apply if a child's educational performance is adversely affected primarily because the child has an emotional disturbance, as defined in paragraph (b)(4) of section 300.7 to 300.18.
  2. A child who manifests the characteristics of autism after age 3 could be diagnosed as having autism if the criteria in paragraph (c)(1)(i) of section 300.7 to 300.18 are satisfied.
- B. *Deaf-blindness* means concomitant hearing and visual impairments, the combination of which causes such severe communication and other developmental and educational needs that they cannot be accommodated in special education programs solely for children with deafness or children with blindness.
- C. *Deafness* means a hearing impairment that is so severe that the child is impaired in processing linguistic information through hearing, with or without amplification, that adversely affects a child's educational performance.
- D. *Emotional disturbance* is defined as follows:
1. The term means a condition exhibiting one or more of the following characteristics over a long period of time and to a marked degree that adversely affects a child's educational performance:
    - (a) An inability to learn that cannot be explained by intellectual, sensory or health factors.
    - (b) An inability to build or maintain satisfactory interpersonal relationships with peers and teachers.
    - (c) Inappropriate types of behavior or feelings under normal circumstances.
    - (d) A general pervasive mood of unhappiness or depression.
    - (e) A tendency to develop physical symptoms or fears associated with personal or school problems.

2. The term includes schizophrenia. The term does not apply to children who are socially maladjusted, unless it is determined that they have an emotional disturbance.
- E. *Hearing impairment* means an impairment in hearing, whether permanent or fluctuating, that adversely affects a child's educational performance but that is not included under the definition of deafness in this section.
- F. *Mental retardation* means significantly sub-average general intellectual functioning, existing concurrently with deficits in adaptive behavior and manifested during the developmental period that adversely affects a child's educational performance.
- G. *Multiple disabilities* means concomitant impairments (such as mental retardation-blindness, mental retardation-orthopedic impairment, etc.), the combination of which causes such severe educational needs that they cannot be accommodated in special education programs solely for one of the impairments. The term does not include deaf-blindness.
- H. *Orthopedic impairment* means a severe orthopedic impairment that adversely affects a child's educational performance. The term includes impairments caused by congenital anomaly (e.g., clubfoot, absence of some member, etc.), impairments caused by disease (e.g., poliomyelitis, bone tuberculosis, etc.), and impairments from other causes (e.g., cerebral palsy, amputations, and fractures or burns that cause contractures).
- I. *Other health impairment* means having limited strength, vitality or alertness, including a heightened alertness to environmental stimuli, that results in limited alertness with respect to the educational environment, that—
1. Is due to chronic or acute health problems such as asthma, attention deficit disorder or attention deficit hyperactivity disorder, diabetes, epilepsy, a heart condition, hemophilia, lead poisoning, leukemia, nephritis, rheumatic fever, and sickle cell anemia; and
  2. Adversely affects a child's educational performance.
- J. *Specific learning disability* is defined as follows:
1. The term means a disorder in one or more of the basic psychological processes involved in understanding or in using language, spoken or written, that may manifest itself in an imperfect ability to listen, think, speak, read, write, spell, or to do mathematical calculations, including conditions such as perceptual disabilities, brain injury, minimal brain dysfunction, dyslexia and developmental aphasia.

2. The term does not include learning problems that are primarily the result of visual, hearing, or motor disabilities, of mental retardation, of emotional disturbance or of environmental, cultural or economic disadvantage.
- K. *Speech or language impairment* means a communication disorder, such as stuttering, impaired articulation, a language impairment, or a voice impairment, that adversely affects a child's educational performance.
- L. *Traumatic brain injury* means an acquired injury to the brain caused by an external physical force, resulting in total or partial functional disability or psychosocial impairment, or both, that adversely affects a child's educational performance. The term applies to open or closed head injuries resulting in impairments in one or more areas, such as cognition; language; memory; attention; reasoning; abstract thinking; judgment; problem-solving; sensory, perceptual, and motor abilities; psychosocial behavior; physical functions; information processing; and speech. The term does not apply to brain injuries that are congenital or degenerative, or to brain injuries induced by birth trauma.
- M. *Visual impairment, including blindness*, means an impairment in vision that, even with correction, adversely affects a child's educational performance. The term includes both partial sight and blindness.



**SAMPLE CONTINUUM  
OF TRANSPORTATION SERVICES FOR STUDENTS WITH DISABILITIES  
(CHOICE OF OPTION THAT MAY BE AVAILABLE, AS APPROPRIATE)**

<b>Least Restrictive</b>	<b>Parent/guardian to provide their own child's Transportation with district reimbursement</b>						<b>Most Restrictive</b>
Student walks to school alone or with peers	Student uses public transit one way	Student combines school bus with public transit	Student uses public transit both ways	Student rides school bus with modification or lift	Student rides school bus with support network  w w/o adaptive equipment	Student rides public transportation with support network	<b>HOME CORNER BUS STOPS OR SCHOOL PICK-UP SITES</b>  <b>HOME PICK-UP OR HOME CORNER PICK-UP</b>  <b>HOME OR INSTITUTION PICK-UP</b>
				Student rides integrated school bus with support network  w w/o adaptive equipment	Student rides modified bus with students with disabilities  w w/o adaptive equipment	Student rides modified bus with attendant  w w/o adaptive equipment	
					Student rides bus with attendant and/or nurse with special training  Possibly with limited ride time  Possibly with specially equipped vehicle  Possibly with intervention	Student needs specialized pick-up or bus ride ALONE with attendant	
					Possibly with limited ride time  Possibly with specially equipped vehicle  Possibly with intervention	Student needs specialized bus ride with specialized attendant	
						Student needs bus alternative for out of town travel	

**IDEA-PART B FINAL REGULATIONS\***  
**DISCIPLINE PROCEDURES**  
**(March 1999)**

**Introduction**

- A. Prior to enactment of the IDEA Amendments of 1997, the statute specifically addressed only the issue of discipline in a provision that allowed school personnel to remove a child to an interim alternative educational placement for up to 45 days if the child brought a gun to school or to a school function. The 1997 Amendments incorporated prior court decisions and Department policy that had held that:
1. Schools could remove a child for up to ten school days at a time for any violation of school rules as long as there was not a pattern of removals;
  2. A child with a disability could not be long-term suspended or expelled from school for behavior that was a manifestation of his or her disability; and
  3. Services must continue for children with disabilities who are suspended or expelled from school.
- B. In addition, the 1997 Amendments:
1. Expanded the authority of school personnel regarding the removal of a child who brings a gun to school to apply also to all dangerous weapons and to the knowing possession of illegal drugs or the sale or solicitation of the sale of controlled substances; and
  2. Added a new ability of schools to request a hearing officer to remove a child for up to 45 days if keeping the child in his or her current placement is substantially likely to result in injury to the child or to others.
- C. The Amendments also added new provisions that require schools to assess a child's troubling behavior and develop positive behavioral interventions to address that behavior, and that describe how to determine whether the behavior was a manifestation of the child's disability.
- D. The final regulations incorporate the statutory provisions described above, and provide additional specificity on a number of key issues:
1. **Removals of Up to Ten School Days at a Time**  
  
The regulations clarify that school personnel may remove a child with a disability for up to ten (10) school days, and for additional removals of up to ten school days for separate acts of misconduct, as long as the removals do not constitute a pattern.

2. **Providing Services During Periods of Disciplinary Removal**

Schools do not need to provide services during the first ten school days in a school year that a child is removed.

During any subsequent removal that is for ten school days or less, schools provide services to the extent determined necessary to enable the child to appropriately progress in the general curriculum and appropriately advance toward achieving the goals of his or her IEP. In cases involving removals for ten school days or less, school personnel, in consultation with the child's special education teacher, make the service determination.

During any long-term removal for behavior that is not a manifestation of a child's disability, schools provide services to the extent determine necessary to enable the child to appropriately progress in the general curriculum and appropriately advance toward achieving the goals of his or her IEP. In cases involving removals for behavior that is not a manifestation of the child's disability, the child's IEP team makes the service determination.

3. **Conducting Behavioral Assessments and Developing Behavioral Interventions**

Meetings of a child's IEP team to develop a behavioral assessment plan, or (if the child has one) to review the child's behavioral intervention plan, are required only when the child has first been removed from his or her current placement for more than ten school days in a school year, and when commencing a removal that constitutes a change in placement.

If other subsequent removals occur, the IEP team members review the child's behavioral intervention plan and its implementation to determine if modifications are necessary, and only meet if one or more team members believe that modifications are necessary.

4. **Change of Placement; Manifestation Determinations**

The regulations provide that a change of placement occurs if a child is removed for more than ten consecutive school days or is subjected to a series of removals that constitute a pattern because they cumulate to more than ten school days in a school year, and because of factors such as the length of each removal, the total amount of time the child is removed, and the proximity of the removals to one another.

Manifestation determinations are required only if a school is implementing a removal that constitutes a change in placement.



# **APPENDIX E**

## **Resources**



Dated August 22, 2003

Contact Persons:

Name: JoLeta Reynolds  
Telephone: (202) 205-5507  
(press 3)  
Name: Thomas Irvin  
Telephone: (202) 205-5803

OSEP 03-10

**MEMORANDUM**

TO: State Directors of Special Education

FROM: Stephanie Smith Lee  
Director  
Office of Special Education Programs

SUBJECT: Ensuring Safe and Appropriate Transportation for Children with Disabilities

As you know, being transported to and from school by school bus is a major factor of school life for millions of children, nationally, including many children with disabilities. Transportation is a costly venture. For example, during the 1999-2000 school year, the nation's school districts spent over **\$13 billion** on home-to-school and school-to-school transportation for students in public schools. Of that amount, an estimated **\$3.7 billion** (or 28% of the \$13.1 billion) was for special transportation services for children with disabilities.<sup>1</sup>

In meetings (and correspondence) with representatives of two major national transportation associations (i.e., the National School Transportation Association, and the National Association for Pupil Transportation), these representatives have expressed concerns that transportation providers are often not included in local school district plans or training related to transporting children with disabilities. They also provided examples of problems resulting from not having prior knowledge about the needs of some of these children, and expressed interest in finding ways to ensure that transportation of children with disabilities is safely and appropriately provided.

---

<sup>1</sup> American Institutes for Research, Center for Special Education Finance, Report 3: *What Are We Spending on Transportation Services for Students with Disabilities, 1999-2000?* (Revised 4/17/03).

ways to ensure that transportation of children with disabilities is safely and appropriately provided.

The current regulations implementing Part B of the Individuals with Disabilities Education Act (IDEA) include a number of provisions related to transportation of children with disabilities. See e.g., -- (1) the definition of related services, which lists transportation, and includes a separate definition of “transportation” (34 CFR §300.24(a); (b)(15)); (2) Appendix A--Notice of Interpretation, which includes questions and answers regarding the provision of transportation in individualized education programs (i.e., Q-30 (64 FR 12478, March 12, 1999) and Q-33 (64 FR 12479); and (3) Attachment 1 to the 1999 Part B Regulations (Analysis of Comments and Changes) that includes a discussion about transportation as a related service (64 FR 12551).

To the extent appropriate, we encourage you to contact the local educational agencies in your State to call their attention to the transportation provisions in the regulations, and to encourage them, as appropriate, (consistent with the confidentiality provisions in §§300-560-300.576), to ensure that there is meaningful and effective communication -- before the fact -- between school district personnel and transportation providers about the transportation needs and potential problems of individual students with disabilities. This effort should be beneficial to all affected parties, but especially the children who are being transported.

Transportation providers play an integral role in the school lives of many children, including children with disabilities, which makes effective communication between the school and the providers essential. We believe that, for the safety and well-being of all children who ride school buses, including children with disabilities, it is crucial that they are appropriately and effectively transported by well-informed and well-trained transportation providers.

If you have questions or comments about this memorandum, please contact your Part B State contact or the persons listed above.

cc: Chief State School Officers  
Federal Resource Center  
Regional Resource Centers  
Parent Training Centers  
Protection and Advocacy Agencies  
Section 619 Coordinators





**NATIONAL ASSOCIATION OF  
STATE DIRECTORS OF  
PUPIL TRANSPORTATION SERVICES**

**Excerpts From**

**Information Report**

**Sharing Student Health and Medical Information with  
School Transporters**

**by Peggy A. Burns, Esq.**

**Background**

This Information Report is not intended to be an exhaustive discussion of records disclosure and confidentiality provisions, since there are multiple situations in which school transporters require student information in order to safely and efficiently carry out their responsibilities. Rather, it focuses on communicating to school transporters and special education directors the necessity -- and legitimacy -- of disclosure of student health and medical information. Included in the category of “school transporters” are transportation administrators, drivers, and other appropriate school transportation staff members, as well as bus contractors hired by school districts and educational units to transport students to and from school and school-related activities. School transporters and special education directors are urged to seek legal advice regarding specific applications of this information.

It is critical that school transporters have relevant health and medical information about the students who ride their buses, and in some cases it is legally mandated. Even where there is not a statutory or regulatory mandate to provide this information to school transporters, any reasonable risk management analysis readily leads to the conclusion that the potential harm from failure to share this information far outweighs any risk that a school district or contractor could incur as a result of transporters having this information.

Despite these facts, however, special education and other school personnel are often reluctant to share student health and medical information with school transporters. Many are adamant about their “inability” to provide information about students’ conditions and needs which may impact travel on the school bus. The reason -- misinformation about “and/or misunderstanding of confidentiality requirements.

**Questions**

- Can school transporters legally receive health and medical information about students who ride their buses?

- What factors should be considered in determining whether transportation personnel, special education personnel, medical personnel and parents should collaborate to accomplish this sharing of information?
- What are the prerequisites to the sharing of student health information with school transporters?
- How can compliance with these prerequisites be achieved?

## Discussion

### *Application of relevant statutory and regulatory information.*

Several clear, guiding principles emerge from an understanding of applicable law, especially the Regulations implementing Part B of the Individuals with Disabilities Education Act (hereafter, “IDEA”), and the Family Educational Rights and Privacy Act of 1974 (hereafter, “FERPA.”)

### **Principle 1 – Rationale for Disclosure**

When transportation is provided as a related service to a special education student -- that is, because transportation is necessary for the child to access Individualized Education Program (IEP) services -- then transporters are related service providers. [See IDEA Regulations (hereafter “Regs”), Section 300.24.] Under such circumstances, the school district *must provide necessary information to school transporters. That information includes setting forth the role of transportation personnel in meeting the unique needs of the child as identified in his/her IEP, and those “accommodations, modifications, and supports” identified in the child’s IEP which relate in any way to the transportation environment. [See Regs., Section 300.342(b) (2) and (3).]*

*While the IDEA Regulations impose a mandatory duty on school districts when transportation is a related service, FERPA provides for broader permission to disclose information about a child under two situations:*

- (1) when a parent consents to the disclosure; or*
- (2) when “school officials” have a “legitimate educational interest,” even when the district has not obtained such prior consent.*

### ***Who is a school official with a legitimate educational interest?***

When FERPA was modified in 1996, a “Model Notification of Rights Under FERPA for Elementary and Secondary Institutions” was included in Appendix B. That Model Notification clearly demonstrates Congressional intent as to who might reasonably be entitled to receive student information:

**“A school official** is a person employed by the District as an administrator, supervisor, instructor or **support staff member**. . . ; a person serving on the School Board; a **person or company with whom the District has contracted to perform a special task**. . .”

And, a school official has “a **legitimate educational interest** if the official needs to review an education record in order to fulfill his or her professional responsibility.”

It is clear that school transporters meet this standard when student health and medical information is necessary to enable the safe and efficient transport of a student.

### **Principle 2 – Publication of List**

Under IDEA, school districts and contractors must publish a notice setting forth those staff members who will have access to student information. [See Regs., Sec. 300.572(d).] FERPA requires that school districts that share information with staff members or contractors, recognized as needing student information, specify “criteria” for determining who will receive such information and under what circumstances.

These requirements are easily met by including in student/parent handbooks a statement like the following, as suggested in Appendix B to FERPA:

“Federal law permits the school district to disclose personally identifiable information in the student’s education records to ‘school officials with legitimate educational interests.’ School officials include persons employed by the district as an administrator, supervisor, teacher, or support staff member (including but not limited to . . . transportation personnel. . .); . . . or a person, agency, or company with whom the District has contracted, or otherwise arranged to perform a special task or service. . . Such individuals have a legitimate educational interest if s/he needs to review an education record in order to fulfill his or her professional and/or official responsibility.

A legitimate educational interest also exists where the staff member or other individual works directly with students and needs to review education records to increase his/her awareness of steps necessary for the safety and welfare of students and staff members.”

### **Principle 3 – Confidentiality**

The IDEA Regulations recognize that confidentiality requirements apply to the provision of necessary student information to school district employees and school transportation contractors. These requirements do not prohibit disclosure, but merely impose on the “agency or institution that collects, maintains or uses personally identifiable information, or from which information is obtained” the duty to protect the confidentiality of such information “at collection, storage, disclosure and destruction stages.” [See Regs., Sec. 300.572 (a).] This duty is further defined by the FERPA requirement that a school district share personally identifiable information from an education record only on the condition that the recipient of the information will not disclose the information to any other party without the prior consent of the parent or eligible student.

### **Principle 4 – Training**

In order to receive student information which is otherwise confidential, school transporters must receive training -- like all other personnel who receive this information in the course of their job duties.

All related services personnel must be “trained,” and the Official Commentary to Section 300.24 of the Regs specifically includes “bus drivers” among such personnel. The Regs further state that “all persons collecting or using personally identifiable information must receive training or instruction regarding” limitations imposed by IDEA and FERPA and state policies and procedures which implement the disclosure and confidentiality provisions of these federal laws. [See Regs., Section 300.572 (c).]

### **The Bottom Line: Why Should School Districts Ensure That Pupil Transportation Official Have Access to Student Information?**

#### ***Participation in IEP Meetings.***

As indicated above, the duty to inform is mandatory under IDEA Regulations when school transportation is provided as a related service. School transporters are essential participants in the decision which must be made as to whether transportation is a related service for a particular child. Section 300.344 of the Regs. provides that a local education agency may include related services personnel as appropriate at the IEP meeting. Appendix A of the IDEA Regulations includes many useful questions and answers on this subject.

- The answer to Question 30 states: “. . . [I]t is appropriate for [related services personnel] to be included if a particular related service is to be discussed as part of the IEP meeting.”
- The answer to Question 33 states: “In determining whether to include transportation in a child’s IEP and whether the child needs to receive transportation as a related service, it would be appropriate to have at the IEP meeting a person with expertise in that area.” That expertise will be most evident -- and most valuable -- when members of the IEP team have necessary information about the needs of the student.

In its *Letter to Smith* (July 12, 1995), and in a number of letters and opinions since then, the Office of Special Education Programs (OSEP) of the U.S. Department of Education stated that the IEP must include more than a “yes” or “no” to the question, “Is transportation a related service?” Rather, it must include accommodation, modifications, and supports which must be provided for the child in accordance with his/her unique needs. Transporters are likely to be more aware of the availability of assistive technology devices applicable to transportation than anyone else on the IEP team, and certainly will have the responsibility to properly use such devices in response to the child’s needs. Health and medical information is essential to this end. OSEP specifically noted in its *Letter to Smith*: “In all instances, each student’s need for transportation as a related service and the type of transportation to be provided are issues to be discussed and decided during the evaluation process and individualized education program (IEP) meeting, and the transportation arrangements agreed upon should be included in the disabled student’s IEP.”

“Transportation arrangements” are obvious components of the information transporters must receive. But remember, Section 300.342(b)(3) of the Regulations implementing Part B of the

IDEA mandates that each related service provider know what s/he must do specifically to implement the IDEA. Consequently, other information, such as behavior intervention plans or assistive technology details, must be shared with school transporters in order to comply with this provision.

Finally, in order to determine necessary components of training for transporters, it is critical to share student health and medical information with driver trainers, and the occupational therapists, physical therapists, nurses and others who will work with them. How else can drivers and aides be aware of proper responses to the unique medical needs of students?

***Supporting the district's proposed transportation plan.***

A recent California case shows how driver training and provision of health and medical information can be an invaluable tool to help demonstrate that your chosen method of transportation for a particular student is reasonably calculated to meet his/her needs.

In Pleasant Valley School District, (37 IDELR 265, August 21, 2002), parents of a student with short-gut syndrome objected to the district's proposal to provide regular district transportation instead of continuing the door-to-door transportation the boy had received for more than three years.

Among the parents' concerns was the possibility that the student's g-tube would become dislodged or that he would have a seizure. The school nurse had trained the driver on whose bus the student had ridden, and could train other drivers accordingly. An emergency care plan, which would be shared with anyone who drove the student, embodied the proper procedures to employ in the event that the g-tube became dislodged. The plan also included the proper procedures to undertake should the student suffer a seizure. The fact that the driver would be ready if an emergency occurred was instrumental in the Hearing Officer's concluding that proper accommodations could be made on the regular education bus to address the unique needs of the child.

While school districts cannot be insurers of students' safety, they do have an obligation to take reasonable steps to respond to known dangers which may threaten the welfare of students and others. Students who, though not requiring special education, have health or medical challenges, may have a health action plan or other protocol which could have a bearing on school transportation.

**Are There Risks to School Districts if Information is Shared With Transporters?**

Generally, a single mistake by a school district or contractor will not amount to a violation of FERPA. However, the Family Compliance Office of the U.S. Department of Education, which investigates, processes and reviews complaints and violations under FERPA, may take steps regarding individuals who improperly disclose information from education records. Section 99.33 of the Regulations implementing FERPA provides:

“If this Office determines that a third party improperly re-discloses personally identifiable information from education records in violation of [FERPA], the educational agency or institution may not allow that third

party access to personally identifiable information from education records for at least five years.”

The implications of this section are significant. Since a school district makes a commitment when sharing information with a bus driver that the driver will not inappropriately “re-disclose” the information to a third party, there can be strong sanctions if that condition is not met. Since a driver needs certain information in order to do his/her job, a restriction which prevents access to necessary information for at least five years means that the driver cannot do his or her job. That situation would most likely result in termination. Even absent federal agency determination of a breach of confidentiality, or a privately brought action based on invasion of privacy or inaccuracy of the information, a school district might well consider this a sufficiently serious rule violation to impose consequences up to and including termination.

A school district violates FERPA if it has a policy of denying access to records to parents, or it has a policy of wrongly disclosing information to third parties. A parent or student over the age of 18 may file a complaint giving specifics about why that person thinks a school district has violated FERPA. The complaint must be submitted within 180 days of the alleged violation or of the date that the complainant knew of, or reasonably should have known of, the alleged violation.

Following an agency investigation in which it is determined that a violation had occurred, the Family Compliance Office may take a number of steps:

- It will give the school district a reasonable period of time to comply with specific steps set out by the Office; and
- If the school district does not comply within that period, the Office may withhold federal monies, and/or issue an order to compel compliance.

Before the extreme sanction of loss of eligibility for federal funds is applied, a school district must not only have a policy and practice of violating FERPA, but also refuse to take steps to comply with FERPA within a reasonable period of time.

Therefore, the school district which shares necessary information with drivers risks little. That is especially true in comparison with the potential risks to the safety and welfare of the student if important information is not shared. On the other hand, the driver who does not take that responsibility seriously risks losing his or her job.

### **Conclusion**

School transporters can legally receive information about students’ health and medical conditions when these conditions may impact transportation planning and implementation.

Factors to be considered in setting conditions for such disclosure include:

- (1) the determination of legitimate educational interest;
- (2) compliance with FERPA requirements of notice;

- (3) requiring confidentiality of the school transporters to whom the information is disclosed; and
- (4) training.

It is clear that once school transporters are trained regarding the requirements of confidentiality, school district and medical personnel are well-advised to share this information.

© National Association of State Directors of Pupil Transportation Services. All rights reserved. March 2003, used by permission from NASDPTS.

## APPENDIX

### Relevant Federal Regulations

#### **IDEA Regulations**

*Sec. 300.342(b)(2) and (3):* “Each public agency shall ensure that. . .[t]he child’s IEP is accessible to each. . .related service provider. . .who is responsible for its implementation;” and “Each. . . provider described in paragraph (b)(2) of this section is informed of - (i) His or her specific responsibilities related to implementing the child’s IEP; and (ii) The specific accommodations, modifications, and supports that must be provided for the child in accordance with the IEP.”

*Sec. 300.560(c):* “*Participating agency means any agency or institution that collects, maintains, or uses personally identifiable information, or from which information is obtained, under Part B of the Act.*”

*Sec. 300.560(b):* “*Education records means the type of records covered under the definition of ‘education records’ in 34 CFR part 99 (the regulations implementing the Family Educational Rights and Privacy Act of 1974.)*”

*Sec. 300.563:* “*Each participating agency shall keep a record of parties obtaining access to education records collected, maintained, or used under Part B of the Act (except access by parents and authorized employees of the participating agency), including the name of the party, the date access was given, and the purpose for which the party is authorized to use the records.*”

*Sec. 300.572(a):* “*Each participating agency shall protect the confidentiality of personally identifiable information at collection, storage, disclosure and destruction stages.*”

*Sec. 300.572(c):* “*All persons collecting or using personally identifiable information must receive training or instruction regarding the State’s policies and procedures under Sec. 300.127 and 34 CFR part 99.*”

*Sec. 300.572(d):* “*Each participating agency shall maintain, for public inspection, a current listing of the names and positions of those employees within the agency who may have access to personally identifiable information.*”

#### **FERPA Regulations**

*Sec. 99.3:* “*‘Education Records’ . . .means those records that are: (1) Directly related to a student; and (2) Maintained by an educational agency or institution or by a party acting for the agency or institution.*”

*Sec.99.7(3):* “*The notice [which must be provided annually to parents concerning their rights under FERPA] . . .must include. . .if the educational agency or institution has a policy of disclosing education records under Sec. 9.31(a)(1), a specification of criteria for determining who constitutes a school official and what constitutes a legitimate educational interest.*”

*Sec. 99.31(a)(1):* “*An educational agency or institution may disclose personally identifiable information from an education record of a student without the consent required by Sec. 99.30 if the disclosure meets one or more of the following conditions: (1) The disclosure is to other school officials, including teachers, within the agency or institution whom the agency or institution has determined to have a legitimate educational interest.*”



# Ride Safe

Information to help you travel more safely  
in motor vehicles while seated in your wheelchair.



Rehabilitation Engineering Research Center  
on Wheelchair Transportation Safety



---

University of Michigan  
Health System

---

University of Michigan  
Transportation Research Institute

---

Initially funded through a grant from the FRIENDS  
of the University of Michigan Hospitals

---

2005

**When traveling in a motor vehicle**, it is generally safest for wheelchair users to transfer to a vehicle seat and use the vehicle seatbelt system or a child safety seat that complies with federal safety standards. The wheelchair should then be stored and secured in the vehicle.

If transferring is not feasible, it is very important to secure the wheelchair to the vehicle facing forward and to use crash-tested seatbelts for the wheelchair-seated rider.



## START WITH THE RIGHT EQUIPMENT

### The Wheelchair

It is best if you have a wheelchair that has been designed and tested for use as a seat in motor vehicles, often referred to as a **WC19 wheelchair** or a **transit wheelchair**. These wheelchairs comply with ANSI/RESNA WC19, a voluntary standard developed by safety and rehabilitation experts. Wheelchairs that meet the design and performance requirements of this standard will be labeled to show that they comply with WC19.

Most importantly, a WC19 wheelchair has four, crash-tested securement points where tiedown straps and hooks can be easily attached. These points are clearly marked with a hook symbol.

If a WC19 wheelchair is not available, the next best choice is a wheelchair with an accessible metal frame where tiedown straps and hooks can be attached at frame junctions.

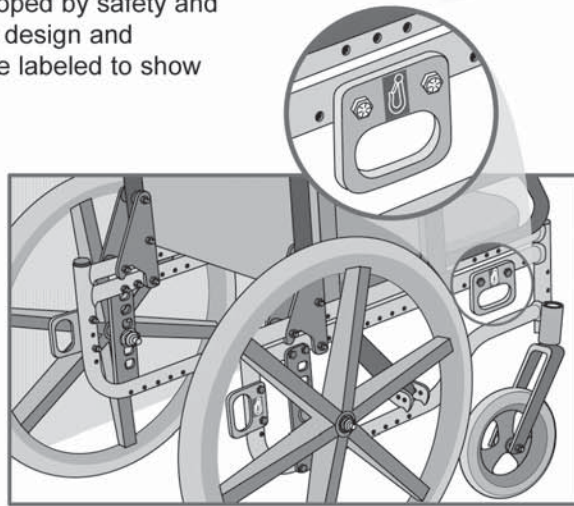

### The Wheelchair Tiedown and Occupant Restraint System (WTORS)

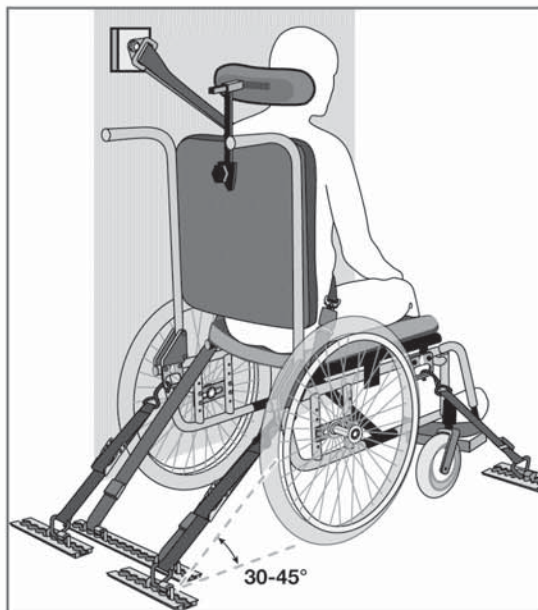

It is important to use a complete WTORS to secure the wheelchair and provide the wheelchair occupant with a properly designed and tested seatbelt system.

**Always use a WTORS that has been crash tested and labeled as complying with SAE J2249**, a voluntary standard developed by safety and rehabilitation experts. The most common type of wheelchair tiedown uses four straps to secure the wheelchair to the vehicle. Although it requires someone other than the wheelchair rider to secure and release the wheelchair, this tiedown can secure a wide range of WC19 and non-WC19 wheelchairs.

To protect the rider during a crash or sudden braking, and to minimize the likelihood of injury caused by contact with the vehicle, a seatbelt system with both pelvic and upper torso belts must be used.

## 2

# SECURE THE WHEELCHAIR

## Four-Point Tiedowns

▶ Always position the wheelchair and rider facing forward in the vehicle.

▶ When securing a WC19 wheelchair, attach the four tiedown straps to the securement points provided on the wheelchair. Tighten the straps to remove all slack.

▶ If you do not have a WC19 wheelchair, it is best to attach the tiedown straps to welded junctions of the wheelchair frame or to other structural areas where the frame is fastened together with hardened steel bolts indicated by six raised lines or bumps on the bolt head.

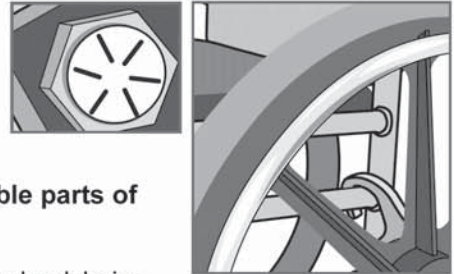

▶ **Do not attach tiedowns to adjustable, moving, or removable parts of the wheelchair such as armrests, footrests, and wheels.**

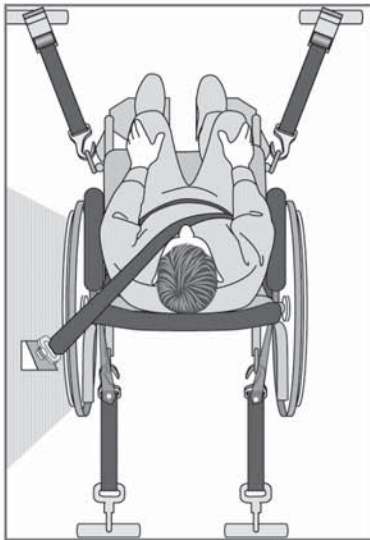

▶ When securing non-WC19 wheelchairs, choose structural securement points as close to the seat surface as possible to provide greater wheelchair stability during travel. It is best if the rear securement points are high enough to result in angles of the rear tiedown straps between 30 and 45 degrees to the horizontal.

▶ If you have a non-WC19 wheelchair with a tilt seat, make sure to attach both the front and rear straps to either the seat frame or to the base frame. Mixing wheelchair securement points between the seat and base can result in the tiedown straps becoming slack if the angle of the seat changes during a crash.

▶ It is best if floor anchor points for rear tiedown straps are located directly behind the rear securement points on the wheelchair. If possible, the front tiedown straps should anchor to the floor at points that are spaced wider than the wheelchair to increase lateral stability during travel.

## Other Methods of Wheelchair Securement

▶ In addition to securing wheelchairs using a four-point tiedown, wheelchairs can also be secured using a docking tiedown device. This method is primarily used in private vehicles since it requires the addition of adaptor hardware to the wheelchair frame that will engage with the docking tiedown device in the vehicle. Docking securement devices allow the wheelchair rider to secure and release the wheelchair without assistance.

▶ If you plan to secure your wheelchair with a docking tiedown device, you should check with the WTORS or wheelchair manufacturer to ensure that your wheelchair model has been successfully crash tested with their system.

▶ Clamp-type securement devices are not recommended since they do not provide effective wheelchair securement in frontal crash testing.

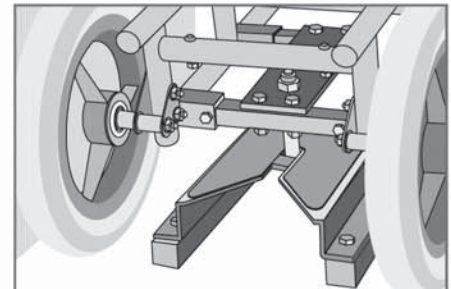

# 3

## PROTECT THE WHEELCHAIR RIDER

► In addition to securing the wheelchair, **it is very important to provide effective restraint for the wheelchair user with a crash-tested lap and shoulder belt or with a child restraint harness.**

Postural support belts attached to the wheelchair are not strong enough to withstand the forces of a crash and are usually not positioned correctly to restrain the occupant safely in a crash.

► The lap belt should be placed low across the front of the pelvis near the upper thighs, not high over the abdomen. When possible, the lap belt should be angled between 45 and 75 degrees to the horizontal when viewed from the side. Some wheelchair features, like armrests, can interfere with good belt fit. To avoid placing the lap belt over the armrest and to keep the lap belt low on the pelvis, it may be necessary to insert the belt between the armrest and the seatback, or through an opening under the armrest.

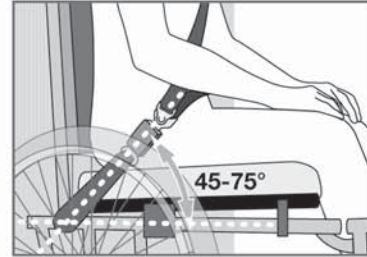

► A diagonal shoulder belt should cross the middle of the shoulder and the center of the chest, and should connect to the lap belt near the hip of the wheelchair rider. The upper shoulder-belt anchor point or D-ring guide should be anchored above and behind the top of the occupant's shoulder, so that the belt is in good contact with the shoulder and chest while traveling.

► Newer WC19 wheelchairs offer the option of a crash-tested lap belt that is anchored to the wheelchair frame. If the wheelchair has an onboard crash-tested lapbelt, complete the belt system by attaching the lower end of a shoulder belt to the lap belt. Crash-tested wheelchair-anchored lap belts will be labeled to indicate that they comply with with ANSI/RESNA WC19.

### Other Important Points

- Read and follow all manufacturers' instructions.
- It is best to ride with the wheelchair backrest positioned at an angle of 30 degrees or less to the vertical. If a greater recline angle is needed, the shoulder belt anchor point should be moved rearward along the vehicle sidewall so the belt maintains contact with the rider's shoulder and chest.
- Maximize the clear space around the rider to reduce the possibility of contact with vehicle components and other passengers in a crash. Cover vehicle components that are close to the rider with dense padding.
- Check WTORS equipment regularly and replace worn or broken components. Keep anchorage track free of dirt and debris.
- If a WTORS and wheelchair have been involved in a vehicle crash, check with the manufacturers to determine if the equipment needs to be repaired or replaced.
- If possible, remove hard trays and secure them elsewhere in the vehicle to reduce the chance of rider injury from contact with the tray. Consider the use of foam trays instead of rigid trays during transit. If it is not possible to remove a hard tray, place dense padding between the rider and the tray and make sure that the tray is securely attached to the wheelchair so it will not break loose and cause injury to other occupants in a crash.
- A properly positioned headrest can help protect the neck in a rear impact.
- If it is necessary to use a head and neck support during travel, soft neck collars are safer than stiff collars or head straps which could cause neck injury in a crash. The soft collar should not be attached to the seating system.
- Secure medical and other equipment to the wheelchair or vehicle to prevent it from breaking loose and causing injuries in a crash.



## RESOURCES

### Organizations

---

Rehabilitation Engineering and Research Center on  
Wheelchair Transportation Safety  
[www.ercwts.pitt.edu](http://www.ercwts.pitt.edu)

University of Michigan Transportation Research Institute  
[www.umtri.umich.edu](http://www.umtri.umich.edu)

University of Pittsburgh  
[www.wheelchairnet.org](http://www.wheelchairnet.org)

Society of Automotive Engineers  
[www.sae.org](http://www.sae.org)

RESNA Rehabilitation Engineering Society of North  
America  
[www.resna.org](http://www.resna.org)

National Highway Traffic Safety Administration  
[www.nhtsa.dot.gov](http://www.nhtsa.dot.gov)

National Mobility Equipment Dealer's Association  
[www.nmeda.org](http://www.nmeda.org)

The Association for Driver Rehabilitation Specialists  
[www.driver-ed.org](http://www.driver-ed.org)

### A Helpful Publication

---

#### *School Bus Transportation of Students in Wheelchairs*

A manual of procedures and practices used by the Washtenaw Intermediate School District for providing effective wheelchair securement and occupant restraint.

Washtenaw Intermediate School District  
734-994-8100  
[www.wash.k12.mi.us](http://www.wash.k12.mi.us)

### Wheelchair Manufacturers (Ask for Frames and/or Seating Products that Comply with WC19)

---

Convoid  
[www.convoid.com](http://www.convoid.com); 800-266-8243

Freedom Designs  
[www.freedomdesigns.com](http://www.freedomdesigns.com); 800-331-8551

GOVAN + wheelchair and docking system  
[www.smd-abitech.com](http://www.smd-abitech.com); 204-975-3004

Invacare  
[www.invacare.com](http://www.invacare.com); 800-333-6900

Mulholland Positioning Systems  
[www.mulhollandinc.com](http://www.mulhollandinc.com); 800-543-4769

Otto Bock  
[www.ottobock.com](http://www.ottobock.com); 800-328-4058

Permobil  
[www.permobil.com](http://www.permobil.com); 800-736-0925

Pride Mobility  
[www.pridemobility.com](http://www.pridemobility.com); 800-800-8586

Sammons Preston  
[www.sammonspreston.com](http://www.sammonspreston.com); 800-323-5547

Sunrise Medical  
[www.sunrisemedicalonline.com](http://www.sunrisemedicalonline.com); 800-333-4000

### Wheelchair Seating Manufacturers (Ask for Products that have been Tested to WC19)

---

Adaptive Engineering Lab  
[www.aelseating.com](http://www.aelseating.com); 800-327-6080

Adaptive Equipment Systems  
[www.aesys.com](http://www.aesys.com); 800-237-2370

### Wheelchair Tiedown and Occupant Restraint Manufacturers (Ask for Products that Comply with SAE J2249)

---

Creative Controls  
[www.creativecontrolsinc.com](http://www.creativecontrolsinc.com); 800-539-7237

EZ-Lock  
[www.ezlock.net](http://www.ezlock.net); 225-214-4620

Orthosafe  
[www.orthosafe.com](http://www.orthosafe.com); 609-587-9444

Q'Straint  
[www.qstraint.com](http://www.qstraint.com); 800-987-9987

SureLok  
[www.sure-lok.com](http://www.sure-lok.com); 866-787-3565



## GLOSSARY OF TERMS

**Anchor point:** The location on a vehicle, wheelchair, or wheelchair tiedown where a belt-restraint or wheelchair-tiedown anchorage is attached.

**ANSI-RESNA WC19 (officially, SECTION 19 ANSI/RESNA WC/VOL. 1 *Wheelchairs for use in Motor Vehicles*):** A voluntary standard for wheelchairs designed for use when traveling facing forward in a motor vehicle. NOTE: ISO 7176/19 is an international transit wheelchair standard that specifies similar design and performance requirements as ANSI/RESNA WC19.

**Belt:** A length of energy-absorbing webbing material used in occupant restraint systems.

**Docking tiedown:** A method for securing wheelchairs where portions of the wheelchair frame, or add-on components fastened to the wheelchair frame, engage with a securement device anchored to the vehicle.

**Four-point strap-type tiedown:** A method for securing a wheelchair where four straps are attached to the wheelchair at four separate securement points and attached to the vehicle at four separate anchor points.

**Occupant restraint:** A system or device designed to restrain a motor vehicle occupant in a crash by keeping the occupant in the vehicle seat and minimizing contact with the vehicle interior, other occupants, or objects outside the vehicle.

**Postural support:** A padded component and/or belt used to help maintain a person in a desired position during normal wheelchair use. In general postural supports are **not** designed to provide effective occupant restraint in a motor vehicle crash.

**SAE Recommended Practice J2249 (officially, SAE J2249 *Wheelchair Tiedowns and Occupant Restraints for Use in Motor Vehicles*):** A Society of Automotive Engineers Recommended Practice that specifies design and performance requirements for wheelchair tiedown and occupant restraint systems. NOTE: ISO 10542 is an international WTORS standard that specifies comparable design and performance requirements as SAE J2249.

**Securement points:** Specific structural points on the wheelchair base or seat frame that are designed for attachment of wheelchair tiedowns.

**Strap:** A length of webbing material used in wheelchair tiedown systems.

**WC19 wheelchair:** A crash-tested wheelchair with four clearly identified securement points that meets the design and performance requirements of ANSI-RESNA WC19 *Wheelchairs Used as Seats in Motor Vehicles*, and is sometimes called a transit wheelchair.

**Wheelchair tiedown and occupant-restraint system (WTORS):** A complete system for use by wheelchair-seated occupants comprised of a system or device for securing the wheelchair and a belt-type restraint system for limiting occupant movement in a motor vehicle crash.

### Regents of the University of Michigan

David A. Brandon, Ann Arbor; Laurence B. Deitch, Bingham Farms; Olivia P. Maynard, Goodrich; Rebecca McGowan, Ann Arbor; Andrea Fischer Newman, Ann Arbor; Andrew C. Richner, Grosse Pointe Park; S. Martin Taylor, Grosse Pointe Farms; Katherine E. White, Ann Arbor; Mary Sue Coleman (ex officio)

The University of Michigan, as an equal opportunity/affirmative action employer, complies with all applicable federal and state laws regarding nondiscrimination and affirmative action, including Title IX of the Education Amendments of 1972 and Section 504 of the Rehabilitation Act of 1973. The University of Michigan is committed to a policy of nondiscrimination and equal opportunity for all persons regardless of race, sex, color, religion, creed, national origin or ancestry, age, marital status, sexual orientation, disability, or Vietnam-era veteran status in employment, educational programs and activities, and admissions. Inquiries or complaints may be addressed to the University's Director of Affirmative Action and Title IX/Section 504 Coordinator, at the Office of Multicultural Community, 2072 Administrative Services Building, Ann Arbor, Michigan 48109-1432, 734-763-0235, TTY 734-647-1388. For other University of Michigan information, call 734-764-1817.

**APPENDIX F**  
**Infants, Toddlers**  
**and Pre-Schoolers**





## APPENDIX F INFANTS, TODDLERS AND PRE-SCHOOLERS

### A. **Definitions: Infants, Toddlers and Pre-school Children**

For the purpose of clarification, the following terms are defined:

*Newborn* is a child from birth to one month.

*Infant* is a child from one month to one year.

*Toddler* is a child from one year to three years.

*Pre-schooler* is a child from three years to five years.

**Note:** Individual programs may have variations in the usage of these four terms. State laws, policies and guidelines may contain variations in the age range used to define the terms infants, toddlers and pre-schooler. If not specified, newborns will be included in the infant category.

### B. **Laws: Transportation of Infants, Toddlers and Pre-school Children**

A number of laws impact decision-making and the transportation of infants, toddlers and pre-school children. They include the following:

#### 1. **Public Law 93-112 The Rehabilitation Act of 1973**

This law constituted the first national declaration of the rights of individuals with handicaps. Section 504 prohibits discrimination against individuals with handicaps by any recipient of federal funding. It includes young children with a handicap who would otherwise be qualified to participate in and benefit from programs or other activities receiving federal financial assistance.

#### 2. **Public Law 94-142 The Education for all Handicapped Children Act of 1975**

This law guaranteed that a “free appropriate public education,” including special education and related services, be provided to all handicapped children. It detailed steps that must be taken in identifying and evaluating children with handicaps, provided that handicapped students must be educated with other non-handicapped students to the maximum extent appropriate in the Least Restrictive Environment (LRE), and established an elaborate system of procedural safeguards to ensure parental participation in the development and approval of the IEP. Transportation is one of the related services defined in the regulations. It is an important related service because it provides access to all other special education and related services.

#### 3. **Public Law 97-35 The Head Start Act**

The Head Start program was initiated in 1965 as a comprehensive child development program to serve primarily low income children. Predominately, the ages served are from three years to compulsory school attendance age. However, this program has been expanded to provide services that include infants, toddlers and children with disabilities.

The regulations require that a minimum of 10 percent enrollment be available to children with disabilities. While Head Start is intended to serve children from low income families, the regulations permit up to 10 percent of the children served be from families that are not low income. To assist young children to reach their full potential, Head Start provides a comprehensive program that includes health, nutritional, educational, social and other services. One of the requirements of Head Start is the direct participation of parents of children enrolled.

**4. Public Law 99-372  
The Handicapped Children's Protection Act of 1986**

This law amended the Education for all Handicapped Children Act of 1975 to authorize the award of "reasonable attorneys' fees" to parents who prevail in due process hearings and judicial proceedings under Part B of the Education for all Handicapped Children Act of 1975. This is extremely important because disputes that arise about the related-service transportation under Part B can result in costly recovery of attorney fees awarded by the courts to parents.

**5. Public Law 99-457, Part H  
The Education of the Handicapped Act Amendments of 1986**

Within a decade of the passage of the Education for all Handicapped Children Act , Part H was passed to assist states in establishing statewide, comprehensive early intervention services for children with handicaps from birth through age two and their families. Based on the recognition that early intervention enhances the development of handicapped children, this law provides states with financial incentives. Borrowing from IDEA, this law requires that children receive early intervention services as specified in an Individualized Family Service Plan (IFSP). As used in this part, "developmental delay" is defined by the states. Each state must designate the criteria used to determine eligibility for services. Therefore, the types of children served under Part H programs nationwide are, in part, influenced by a state's definition of this population. Transportation is considered an early intervention service and is defined in the Part H regulations.

**6. Public Law 101-336  
The Americans with Disabilities Act of 1990**

The Americans with Disabilities Act (ADA) is a comprehensive civil rights law that enforces the nondiscrimination of persons with disabilities. It does not change or diminish existing provisions of federal law protecting individuals with disabilities under Section 504 or IDEA. The ADA creates a higher standard of nondiscrimination than does Section 504 in that it applies regardless of whether or not federal funding is received. This law applies to all ages, including young children with disabilities. As stated in the statute, the purpose of the ADA is:

- (a) To provide a clear and comprehensive national mandate for the elimination of discrimination against individuals with disabilities;
- (b) To provide clear, strong, consistent and enforceable standards addressing discrimination against individuals with disabilities;
- (c) To ensure that the federal government plays a central role in enforcing the standards established in this Act on behalf of individuals with disabilities; and

- (d) To invoke the sweep of congressional authority, including the power to enforce the Fourteenth Amendment, and to regulate commerce in order to address the major areas of discrimination faced day-to-day by people with disabilities.

The ADA regulation specifically exempts school buses from some of its requirements but does not exempt access to transportation services for infants, toddlers and pre-school children.

**7. Public Law 101-476, Part B  
Individuals with Disabilities Education Act of 1990**

This act renamed the Education for all Handicapped Children Act of 1975 as the Individuals with Disabilities Education Act (IDEA). All previous references to “handicapped children” were changed to “children with disabilities.” Transportation is defined in the regulations as a related service under the Act. In addition, two new categories of disabilities were added: “autism” and “traumatic brain injury.” The law also broadened the definition of the terms “assistive technology device” and “assistive technology service.” These terms are applicable to the provision of the related-service transportation in the regulation.

**8. Public Law 102-119  
The Individuals with Disabilities Education Act Amendments of 1991**

These amendments reauthorized P.L. 99-457, the Education for all Handicapped Children Act Amendments of 1986 as the Individuals with Disabilities Education Act Amendments of 1991. This reauthorization requires participating states to coordinate services and funding sources for the provision of early intervention services to infants and toddlers from birth through age two. The early intervention service transportation is defined in the regulations.

**9. Public Law 105-17  
The Individuals with Disabilities Education Act Amendments of 1997**

This Act was signed into law on June 4, 1997. It is referred to as the “1997 Amendments.” The new legislation is intended to affirm and refine provisions of the prior IDEA Act. The definition of transportation as a related service under Part B remains unchanged.

**10. Public Law 108-446  
Individuals with Disabilities Education Improvement Act of 2004**

On December 3, 2004 the reauthorization of the Individuals with Disabilities Education Act (IDEA) was signed into law. The definition of transportation in this Act remains unchanged.

**C. Definitions: Infants and Toddlers under the Individuals with Disabilities Education Act**

The definition of transportation under the Individuals with Disabilities Education Act is found in P.L. 101-476 (Part B), P.L. 102-119 (Part H) and P.L. 105-117. The definitions found in P.L. 101-476 and P.L. 102-119 differ significantly in their provisions because of the ages covered under each of the statutes. The requirements of each authorization of IDEA are listed below:

**1. Public Law 101-476, Part B  
Individuals with Disabilities Education Act of 1990**

The definition of transportation under the provisions of P.L. 101-476 (formerly P.L. 94-142) identifies transportation as a related service (Part B) under the IDEA regulations 300.16 and defines “transportation” as including:

- (a) travel to and from school and between schools;
- (b) travel in and around school buildings; and
- (c) specialized equipment (such as special or adapted buses, lifts, and ramps), if required to provide special transportation for a child with a disability.

**2. Public Law 102-119  
The Individuals with Disabilities Education Act Amendments of 1991**

The definition of transportation under the provisions of P.L. 102-119 (formerly P.L. 99-457) identifies transportation and related costs as an early intervention service (Part H) under the IDEA regulations 303-12 (d)(15), which are described as follows: “Transportation and related costs include the costs of travel (e.g., mileage, or travel by taxi, common carrier or other means) and other costs (e.g., tolls and parking expenses) that are necessary to enable a child eligible under this part and the child’s family to receive early intervention services.”

**3. Public Law 105-17  
The Individuals with Disabilities Education Act Amendments of 1997**

Under the IDEA regulations 300.24(b)(15) transportation includes:

- (a) travel to and from school and between schools;
- (b) travel in and around school buildings; and
- (c) specialized equipment (such as special or adapted buses, lifts and ramps), if required to provide special transportation for a child with a disability.

Under Part C of the 1997 Amendments, Early Intervention Program for Infants and Toddlers with Disabilities, the definition of the early intervention service transportation remains unchanged.

**4. Head Start Program Performance Standards on Services for Children with Disabilities (45-CFR 1308)**

These standards set forth the requirements for providing special services for 3 through 5 year old children with disabilities enrolled in Head Start programs. Transportation is addressed in Subpart B - Disabilities Service Plan (h)(6). The related-service transportation is defined as follows:

Transportation for children with disabilities to and from the program and to special clinics or other service providers when the services cannot be provided onsite. Transportation includes adapted buses equipped to accommodate wheelchairs or other such devices, if required.

Transportation is a related service to be provided to children with disabilities. When transportation to the program site and to special services can be accessed from other agencies, it should be used. When it is not available, program funds are to be used to provide it. Special buses and use of taxis are allowable expenses if there are no alternatives available and they are necessary to enable a child to be served, §1308.4 (o)(5).

**5. Head Start Program: 45 Code of Federal Regulations (CFR) Part 1310--Head Start Transportation**

The following passages are quoted from 45 CFR 1310.

**Subpart A—General**

1310.1 Purpose.

Under the authority of sections 640(i) and 645A(b)(9) of the Head Start Act (42 U.S.C. 9801 et seq.), this part prescribes regulations on safety features and the safe operation of vehicles used to transport children participating in Head Start and Early Head Start programs. Under the authority of sections 644(a) and (c) and 645A(b)(9) of the Head Start Act, this part also requires Head Start, Early Head Start and delegate agencies to provide training in pedestrian safety and to make reasonable efforts to coordinate transportation resources to control costs and to improve the quality and the availability of transportation services.

1310.2 Applicability.

(a) This rule applies to all Head Start and Early Head Start agencies, and their delegate agencies (hereafter, agency or agencies), including those that provide transportation services, with the exceptions provided in this section, regardless of whether such transportation is provided directly on agency owned or leased vehicles or through arrangement with a private or public transportation provider. Transportation services to children served under the home based option for Head Start and Early Head Start services are excluded from the requirements of 45 CFR 1310.12, 1310.15(c) and 1310.16. Except when there is an applicable state or local requirement that sets a higher standard on a matter covered by this part, agencies must comply with requirements of this part.

(b) Sections 1310.12(a) and 1310.22(a) of this part are effective January 18, 2006. Sections 1310.11 and 1310.15(c) of this part are effective January 20, 2004.

**Subpart B—Transportation Requirements**

1310.22 Children with disabilities.

(a) Effective January 18, 2006 each agency must ensure that there are school buses or allowable alternate vehicles adapted or designed for transportation of children with

disabilities available, as necessary to transport such children enrolled in the program. This requirement does not apply to the transportation of children receiving home-based services unless school buses or allowable alternate vehicles are used to transport the other children served under the home-based option by the grantee. Whenever possible, children with disabilities must be transported in the same vehicles used to transport other children enrolled in the Head Start or Early Head Start program.

(b) Each Head Start, Early Head Start and delegate agency must ensure compliance with the Americans with Disabilities Act (42 U.S.C. 12101 et seq.), the HHS regulations at 45 CFR part 84, implementing Section 504 of the Rehabilitation Act of 1973 (29 U.S.C. 794), and the Head Start Program Performance Standards on Services for Children with Disabilities (45 CFR part 1308), as they apply to transportation services.

(c) Each agency must specify any special transportation requirements for a child with a disability when preparing the child's Individualized Education Program (IEP) or Individualized Family Service Plan (IFSP), and ensure that in all cases special transportation requirements in a child's IEP or IFSP are followed, including:

- (1) special pick-up and drop-off requirements;
- (2) special seating requirements;
- (3) special equipment needs;
- (4) any special assistance that may be required; and
- (5) any special training for bus drivers and monitors.

#### **6. Head Start Program Deadline Extension: Interim Final Rule, January 16, 2004**

This interim final rule will provide a 150 day extension for those parts of the Head Start transportation regulation that deal with the requirement that each vehicle used to transport children is equipped for use of child safety restraint systems and the requirement that each bus have a bus monitor. Additionally, this rule provided Head Start grantees the opportunity to request further extension of the effective date when such an extension is in the best interest of the children they serve.

Requests for extensions were approved on an individual basis and no extension beyond January 18, 2006, were granted.

#### **D. National Highway Traffic Safety Administration, "Guideline for the Safe Transportation of Pre-school Age Children in School Buses." (February 1999.)**

This guideline provides recommendations for the transportation of pre-school age children in school buses.

**Guideline for the Safe Transportation of Pre-school Age Children in School Buses**  
**National Highway Traffic Safety Administration**  
**February 1999**

**Introduction**

School age children transported in school buses are safer than children transported in motor vehicles of any other type. Large school buses provide protection because of their size and weight. Further, they must meet minimum Federal Motor Vehicle Safety Standards (FMVSSs) mandating compartmentalized seating, improved emergency exits, stronger roof structures and fuel systems, and better bus body joint strength.

As more pre-school age children are transported to school programs, often in school buses, the public is increasingly asking the National Highway Traffic Safety Administration (NHTSA) about how to safely transport them. To help answer these questions, NHTSA conducted crash testing of pre-school age dummies in school bus seats. The test results showed that pre-school age children in school buses are safest when transported in child safety restraint systems (CSRSs) that meet FMVSS 213, Child Restraint Systems, and are correctly attached to the seats.

Based on its research, NHTSA recommends pre-school age children transported in school buses always be transported in properly secured CSRSs. In partial response to questions from school (and child care) transportation offices, this Guideline seeks to assist school and other transportation managers in developing and implementing policies and procedures for the transportation of pre-school age children in school buses.

**Note:** The proper installation of CSRSs necessitates that a school bus seat have safety belts or other means of securing the CSRS to the seat. NHTSA recommends that lap belts or anchorages designed to meet FMVSS 225, Tether Anchorages and Child Restraint Anchorage Systems, be voluntarily installed to secure CSRSs in large school buses.

**Recommendations For the Transportation of Pre-school Age Children in School Buses**

When pre-school age children are transported in a school bus, NHTSA recommends these guidelines be followed:

1. Each child should be transported in a Child Safety Restraint System (suitable for the child's weight and age) that meets applicable Federal Motor Vehicle Safety Standards (FMVSSs).
2. Each child should be properly secured in the Child Safety Restraint System.
3. The Child Safety Restraint System should be properly secured to the school bus seat, using anchorages that meet FMVSSs.

**Child Safety Restraint System Defined**

A Child Safety Restraint System is any device (except a passenger system lap seat belt or lap/shoulder seat belt), designed for use in a motor vehicle to restrain, seat, or position a child who weighs less than 50 pounds.

## Child Safety Restraint Systems Guidelines

### 1. Child Safety Restraint System Specification

The provider of the CSRS should ensure:

- Each pre-school age child to be transported has a CSRS appropriate for the child's weight, height, and age.
- Each CSRS meets all applicable FMVSSs (look for the manufacturer's certification on the label attached to the system).
- Each CSRS has been registered with the CSRSs manufacturer to facilitate any recalls the manufacturer might conduct.
- If the CSRS is the subject of a recall, any necessary repairs or modifications have been made to the manufacturer's specifications.
- Each CSRS is maintained as recommended by its manufacturer, including disposal of any CSRS that has been involved in a crash.

### 2. Proper Securement

The transportation provider should ensure:

- The CSRS is used and secured correctly in the school bus.
- Each child is secured in CSRSs according to manufacturer's instructions.
- All CSRS attachment hardware and anchorage systems meet FMVSS No. 210, Seat Belt Assembly Anchorages or FMVSS No. 225, Tether Anchorages and Child Restraint Anchorage Systems.

School bus seats designated for CSRSs meet FMVSS No. 225, or include lap belts that meet FMVSS No. 209, Seat Belt Assemblies, and anchors that meet FMVSS No. 210 (designed to secure adult passengers or CSRS).

- Personnel responsible for securing CSRSs onto school bus seats and children into CSRSs are properly trained and all personnel involved with CSRSs are provided up-to-date information and training.
- When transported in the school bus, pre-school age children are supervised according to their developmental and functioning level.

### 3. School Bus Seats Designated for Child Safety Restraint Systems

The transportation provider should ensure:

- School bus seats designated for CSRSs are located starting at the front of the vehicle to provide drivers with quick access to and a clear view of the CSRS occupants.
- CSRS anchorages on school bus seats should meet all applicable FMVSSs.
- When ordering new school buses, the maximum spacing specified under FMVSS No. 222, School Bus Passenger Seating and Crash Protection, (within 24 inches from the seating reference point) is recommended for seats designated for CSRSs to provide adequate space for the CSRSs.
- The combined width of CSRS and/or other passengers on a single seat do not exceed the width of the seat.
- If other students share seats with the CSRSs, the CSRSs are placed in window seating position.



#### **4. Retrofitting School Buses**

The transportation provider should ensure:

- Existing school bus seats should only be retrofitted with lap belts or child restraint anchorages as instructed by the school bus manufacturer.
- When a school bus is retrofitted with a seat to allow for proper securement of a CSRS, instructions obtained from the school bus or seat manufacturer on how to install the seat and restraint systems should be followed.
- When a school bus is retrofitted, the bus owner should ensure that seat spacing is sufficient for the CSRS to be used.

#### **5. Evacuation**

The transportation provider should ensure:

- The establishment of a written plan on evacuating pre-school age children and other passengers in CSRSs in the event of an emergency. This written plan should be provided to drivers, monitors, and emergency response personnel. The plan should explicitly state how children (both in and out of the CSRS) should be evacuated from the school bus.
- Evacuation drills are practiced on a scheduled basis, at least as often as that required for the school system's school-aged children.
- All personnel involved in transporting children are trained in evacuation and emergency procedures, including those in the written school bus evacuation plan.
- All school buses carrying children in CSRSs carry safety belt cutters that are accessible only to the driver and any monitors.
- CSRSs are not placed in school bus seats adjacent to emergency exits.
- Local emergency response teams are provided copies of the written school bus evacuation plan, including evacuation of pre-school age children.
- Emergency response personnel should be invited to participate in evacuation drills.

#### **6. Other Recommendations**

The school transportation provider should establish a policy on whether the provider or the child's guardian must supply a CSRS to be used on a school bus. School bus purchases should consider projected ages, sizes, and other characteristics of the students, including any special needs, and whether pre-school age children or medically fragile students will be transported.

Specified procedures should be established for loading and unloading children in CSRSs.

Procedures should be established for the periodic maintenance, cleaning, and inspection for damage of CSRSs. Procedures should be established to train personnel involved in direct service delivery of infants, toddlers, and pre-school children on the physical day-to-day handling of these young children and means to handle potential exposure to contagious and communicable diseases.

When school bus procedures are established, it should be noted that some children in CSRSs may have special needs, including medical fragility that must be addressed on a child-by-child basis.

## **Transportation References**

### **Infants, Toddlers and Pre-Schoolers**

**The following websites provide information pertaining to the transportation of infants, toddlers and pre-schoolers:**

#### **American Academy of Pediatrics**

<http://www.aap.org/>

#### **Head Start Information Publication Center**

[http://www.headstartinfo.org/infocenter/tran\\_tkit.htm](http://www.headstartinfo.org/infocenter/tran_tkit.htm)

#### **Head Start Program Performance Standards, Part 1310. Head Start Transportation**

<http://www.acfhhs.gov/programs/hsb/performance/1310.htm>

#### **Related Information Memorandums**

ACYF-IM-HS-95-25

Transportation Safety

ACYF-IM-HS-95-37

Transportation

ACYF-IM-HS-99-07

New NHTSA “Guideline for the Use of Child Safety Restraint Systems in The Safe Transportation of Pre-School Age Children in School Buses.”

ACYF-IM-HS-01-01

Final rule on Transportation

#### **2001 Head Start Transportation Frequently Asked Questions**

<http://www.headstartinfo.org/faq.htm>

#### **National Education Association**

<http://www.nea.org/>

#### **National Early Childhood Technical Assistance Center (NECTAC)**

<http://www.nectac.org/>

#### **National Highway Traffic Safety Administration**

<http://www.nhtsa.dot.gov>

#### **Office of Special Education and Rehabilitative Services**

<http://www.ed.gov/about/offices/list/osers/osep/index.html>

# **APPENDIX G**

## **Resolutions**



**RESOLUTION NO. 1:  
DRIVER SEAT INTEGRATED  
LAP/SHOULDER BELTS**

**2005**

**WHEREAS,** the 14<sup>th</sup> National Congress on School Transportation (NCST) recognizes that the technology is available to include known safety enhancements on school buses; and

**WHEREAS,** integrated lap and shoulder belts provide occupant protection for a wider range of adult physical characteristics; and

**WHEREAS,** industry officials are committed to providing a safe environment for school bus drivers; and

**WHEREAS,** the 14<sup>th</sup> NCST supports this important federal initiative; now

**THEREFORE, BE IT RESOLVED** that the 14<sup>th</sup> NCST encourages the school bus manufacturers to assist in the design and development of these new standards; and

**BE IT FURTHER RESOLVED** that the National Highway Traffic Safety Administration revise the standard for the school bus driver's seat to include an integrated lap and shoulder belt.

**RESOLUTION NO. 2:  
SEAT BACK HEIGHT**

**2005**

**WHEREAS,** it is in the public interest to adequately protect school bus passengers in the event of a school bus crash; and

**WHEREAS,** the national accident research data demonstrates that enhancements to compartmentalization are necessary; and

**WHEREAS,** the 14<sup>th</sup> National Congress for School Transportation recognizes the importance to include known safety enhancements on school buses; and

**WHEREAS,** industry officials are committed to safe transportation of America's children; now

**THEREFORE, BE IT RESOLVED** that the National Highway Traffic Safety Administration revise the existing standard for school bus passenger seat back height to reflect the research findings.

**RESOLUTION NO. 3:  
RUB RAILS**

**2005**

**WHEREAS,** the delegation of the 14<sup>th</sup> National Congress on School Transportation could not reach consensus on the strength and purpose of rub rails on school buses, and the delegation directed the Body Specifications Writing Committee to resolve the issue;  
now

**THEREFORE, BE IT RESOLVED** that the School Bus Manufacturers Technical Council work with school transportation industry focus groups to determine the functional requirements of rub rails and to recommend a performance-oriented standard to achieve those requirements.

**RESOLUTION NO. 4:  
DEFINITION OF SCHOOL BUS**

**2005**

- WHEREAS,** the 14<sup>th</sup> National Congress on School Transportation (NCST) has a paramount concern for the secure and safe transport of all school children, particularly those in school buses; and
- WHEREAS,** two Federal agencies within the U.S. Department of Transportation—the National Highway Traffic Safety Administration (NHTSA) and the Federal Motor Carrier Safety Administration (FMCSA)—that have regulatory authority over different aspects of school bus transportation; and
- WHEREAS,** the definitions of “school bus” as used by those two regulatory agencies and enacted into Federal law in Title 49 U.S.C. Chapter 301 are very different in scope (see attachment); and
- WHEREAS,** the NHTSA and FMCSA regulatory definitions of “school bus” do not include or make reference to the applicable school bus Federal Motor Vehicle Safety Standards (FMVSS); and
- WHEREAS,** Title 49 U.S.C. Chapter 301 Section 301125 definition of “school bus” does not include or make reference to the applicable school bus FMVSS; however, Section 301111 prescribes the FMVSS; and
- WHEREAS,** the applicable school bus FMVSS are used daily by the school bus industry to define a “school bus”; and
- WHEREAS,** the difference in scope leads to different and inconsistent application of safety requirements to school bus transportation; now
- THEREFORE, BE IT RESOLVED** that the NCST respectfully requests the Secretary, U.S. Department of Transportation to initiate rulemaking to develop a single definition of school bus that will best serve the needs of school bus safety that will be utilized by both NHTSA and FMCSA.



## ATTACHMENT TO RESOLUTION NO. 4

### Title 49 United States Code, Chapter 301 Motor Vehicle Safety

**School bus** means a passenger motor vehicle designed to carry a driver and more than 10 passengers, that the Secretary of Transportation decides is likely to be used significantly to transport preprimary, primary, and secondary school students to or from school or an event related to school.

#### National Highway Traffic Safety Administration:

**School Bus** means a bus that is sold, or introduced into interstate commerce, for purposes that include carrying pre-primary, primary, and secondary school students to and from school or related events, but does not include a bus designed and sold for operation as a common carrier in urban transportation. *[Source: 49 CFR 571.3]*

**Bus** means a motor vehicle with motive power, except a trailer, designed for carrying more than 10 persons, including the driver. *[Source: 49 CFR 571.3]*

#### Federal Motor Carrier Safety Administration:

**School Bus** means a commercial motor vehicle used to transport pre-primary, primary, or secondary students from home to school, from school to home, or to and from school-sponsored events. School bus does not include a bus used as a common carrier. *[Source: 49 CFR 383.5]*

**Commercial Motor Vehicle** means a motor vehicle or combination of motor vehicles used in commerce to transport passengers or property if the motor vehicle –

- (a) Has a gross combination weight rating of 11,794 kilograms or more (26,001 pounds or more) inclusive of a towed unit with a gross vehicle weight rating of more than 4,536 kilograms (10,000 pounds); or
- (b) Has a gross vehicle weight rating of 11,794 or more kilograms (26,001 pounds or more); or
- (c) Is designed to transport 16 or more passengers, including the driver; or
- (d) Is of any size and is used in the transportation of materials found to be hazardous for the purposes of the Hazardous Materials Transportation Act and which require the motor vehicle to be placarded under the Hazardous Materials Regulations (49 CFR part 172, subpart F). *[Source: 49 CFR 383.5]*

**RESOLUTION NO. 5:  
WHEELCHAIR WC-19  
DATA COLLECTION**

**2005**

**WHEREAS,** the 14<sup>th</sup> National Congress on School Transportation (NCST), the National Association of State Directors of Pupil Transportation Services (NASDPTS), the National Association for Pupil Transportation (NAPT) and the National School Transportation Association (NSTA) were instrumental in the development of the ANSI/RESNA WC-19 Standard on wheelchairs intended for use in motor vehicles; and

**WHEREAS,** transportation professionals are working for the safe transportation of individuals with disabilities that travel in wheelchairs and other wheeled mobility devices; and

**WHEREAS,** data collected on crash events could be used to compare WC-19 compliant wheelchairs to non-compliant wheelchairs; now

**THEREFORE, BE IT RESOLVED** that information be collected nationally regarding the impact of the ANSI/RESNA WC-19 Standard on wheelchairs intended for use in motor vehicles. This information would be collected through the cooperative efforts of the Committee on Wheelchairs and Transportation (COWMART), NASDPTS, NAPT and NSTA, as well as the Accident Data Writing Committee of the NCST.

**RESOLUTION NO. 6:  
UNDERRIDE ON SCHOOL BUSES**

**2005**

- WHEREAS,** large numbers of vehicles collide with the rear end of school buses each year, and many of these vehicles underride the school bus, resulting in serious injuries and deaths to occupants of other vehicles; and
- WHEREAS,** most Types A, B, and rear engine Type D school buses have rear bumpers with a ground clearance of approximately 20 inches, and most Type C and front engine Type D school buses have ground clearance up to 30 inches; and
- WHEREAS,** a recent increase in the installation of fuel tanks behind the rear axle between the frame rails on large school buses may increase the potential for a fire resulting from an underride crash; and
- WHEREAS,** currently the Federal government has recognized and legislated rear underride protection height of 22.4 inches for the trailer and semi-trailer industry; and
- WHEREAS,** school buses frequently stop in high-speed areas of the roadway, at railroad crossings, intersections, residential areas and other areas of the road system; and
- WHEREAS,** while underride crashes are not caused by the school bus driver, an industry focused on safety has an obligation to consider the safety of motorists that share roads with school buses; now
- THEREFORE, BE IT RESOLVED** that the 14<sup>th</sup> National Congress on School Transportation (NCST) request the National Highway Traffic Safety Administration (NHTSA) to study and recommend appropriate action to reduce injury and death associated with underride crashes involving collisions to the rear area of school buses.

**RESOLUTION NO. 7:  
ENCOURAGING AND CHRONICLING  
INNOVATION IN SCHOOL TRANSPORTATION**

**2005**

**WHEREAS,** the future improvements in the school transportation industry are highly dependent on innovative practices/procedures, innovative products and technological improvements; and

**WHEREAS,** no central clearinghouse for these innovations currently exists; and

**WHEREAS,** the National Congress on School Transportation (NCST) typically acts upon numerous innovative items; and

**WHEREAS,** the NCST encourages the use of innovative practices, procedures, products and technological improvements that improve the safety, effectiveness and/or efficiency of school transportation operations; now

**THEREFORE, BE IT RESOLVED** that a subcommittee of the NCST be established to chronicle these innovations to be included in the future NCST publication.

**RESOLUTION NO. 8:  
ENGINE COMPARTMENT FIRE PROTECTION  
2005**

**WHEREAS,** the potential exists for fires in the school bus engine compartment to disseminate smoke and flames into the passenger compartment; and

**WHEREAS,** there is a limited amount of time necessary to evacuate a school bus; now

**THEREFORE, BE IT RESOLVED** that the 14<sup>th</sup> National Congress on School Transportation (NCST) requests the School Bus Manufacturers Technical Council (SBMTC) study this concern and make appropriate recommendations to the NCST Steering Committee within twelve months from the date of adoption.

**RESOLUTION NO. 9:  
SCHOOL BUS SECURITY**

**2005**

**WHEREAS,** the school bus is an integral part of our way of life in America and in thousands of communities across our nation approximately 482,000 school buses carry 25 million school children safely to and from school each day; and

**WHEREAS,** in the school transportation industry, the school bus and its occupants are a potential high risk, and a high vulnerability target; and

**WHEREAS,** a foreign or domestic terrorist attack on a school bus would have a devastating effect; and

**WHEREAS,** improving school bus security is complicated because terrorist threats can come from varied sources; and

**WHEREAS,** there currently are limited security awareness training programs designed to address the unique needs of the school bus transportation industry; and

**WHEREAS,** the development of school bus-specific security training programs and the dissemination of those training materials within the industry and the deployment of existing security technology are limited by financial constraints; now

**THEREFORE, BE IT RESOLVED** that the 14<sup>th</sup> National Congress on School Transportation encourages the Congress of the United States to improve school bus security by providing financial assistance for the development of training programs, training of school bus employees and deployment of existing security technology for use in school bus operations; and

**BE IT FURTHER RESOLVED** that the Congress of the United States be requested to fund research to determine if other technology or school bus design considerations may further enhance school bus driver and passenger security. This research should consider technology and design changes for new school buses, as well as the potential for retrofitting existing school buses.

**RESOLUTION NO. 10:  
LAP/SHOULDER BELTS IN SCHOOL BUSES  
HAVING A GVWR OF 10,000 POUNDS OR LESS**

**2005**

**WHEREAS,** school buses having a GVWR of 10,000 pounds or less are an integral part of the school bus fleet in the United States of America; and

**WHEREAS,** small school buses are significantly used as vehicles to transport children having special needs; and

**WHEREAS,** the standard of care for transporting children safely in this type of school bus includes the use of an active passenger restraint/protection system; and

**WHEREAS,** it has been determined by the National Transportation Safety Board that lap belts are not a satisfactory or sufficient type of restraint system for children; now

**THEREFORE, BE IT RESOLVED** that the 14<sup>th</sup> National Congress on School Transportation encourages the National Highway Traffic Safety Administration to change the current federal regulation to allow only lap/shoulder belts for use as passenger restraints in school buses having a GVWR of 10,000 pounds or less.

**RESOLUTION NO. 11:  
HOURS OF SERVICE**

**2005**

**WHEREAS,** the 14<sup>th</sup> National Congress on School Transportation (NCST) has recognized that student safety depends on drivers being well-rested when driving; now

**THEREFORE, BE IT RESOLVED** that the 14<sup>th</sup> NCST recommends that states develop standards, policies and/or procedures that meet or exceed the Federal Motor Carrier Safety Administration's (FMCSA) provisions for hours of service; and

**BE IT FURTHER RESOLVED** that the 14<sup>th</sup> NCST also recommends utilization of the FMCSA's "Moving Kids Safely" program.



# **Committees**

---

## **14th National Congress on School Transportation**

### **Congress Committee List**



**14<sup>th</sup> National Congress on School Transportation**  
**Congress Committee List**  
**\*Chair**

**Steering Committee**

*Charlie Hood	Dennis Hammell
Leanna Depue	Bill Loshbough
Donald Fowler	D. Leeds Pickering
Don Carnahan	Carroll Pitts
Gary Catapano	Rod Nash
Derek Graham	Tom Turner
Ronald Love	Bruce Miles

**General Operations Writing Committee**

*Doug Snyder	George F. Horne
Rodney D. McKnight	Randy Millhollen
Bob Peters	Gary Catapano

**Body Writing Committee**

*Bill Schroyer	Mike Kenney
Chuck Stevenson	Mike Sykes
Danny Thede	Charles Hott
Marshall Casey	Rickey Stanley
Steve Mann	Lt. John Boster
Ron Marion	Rick Lecker
Ron Briggler	Joe Scesny

**Bus Chassis Writing Committee**

*Denny Coughlin	Joe Dominick
Carlisle Beasley	Kenny Allen
David Sluder	Len Hindsley
Herbert Mehnert	Ray Merial
Will Elliot	Steve Hall
Ron Goides	Roger Hanson

**Alternative Fuel Writing Committee**

*Brian Higginbotham	Dan Grohnke
Jay Adams	Bill Schroyer
Ron Goides	Lonnie Young
Vernon Wright	

**Special Needs Operations Writing Committee**

*Alexandra Robinson	Peggy Burns
Robert Cronowirth	Peter J. Grandolfo
Douglas Abbey	Jack Martin
Kathy Furneaux	Mike Roscoe

Jayne Fahle  
Joanne Ivory  
Pauline Gervais  
Rick Rothberg  
Matt Sanchez  
Shirley Francis

Pete Meslin  
Kathryn Cook  
Nick Sanders  
Sue Shutrump  
Launi Schmutz  
Kenneth Allen

**School Activity Writing Committee**

\* Maxine Mougeot  
Greg D. Beach  
John Fairchild  
Diana Hollander  
Allan J. Jones

Doug Kellie  
Vicki Barnett  
Larry Revier  
Debora Romine  
Matt Schultz

**Terms and Definitions Writing Committee**

\*Robin L. Leeds  
Percy L. Abbott  
Vernon Wright

Timothy E. Flood  
Peter J. Grandolfo

**Resolutions Writing Committee**

\*Bill Loshbough  
Jerry Milliken  
Ron Kinney

Nancy Schulz  
George E. Donn

**Appendices Coordination Writing Committee**

\*Nikki Hughes  
Vernon Wright

Barbara Pringle

**Crash Data Writing Committee**

\*Charley Kennington  
Mike Connors  
Dave McDonald  
Theodore S. Finlayson-Schueler

John Dozier  
Robert Pape  
Debora L. Romine

**Infants, Toddlers and Pre-Schoolers Writing Committee**

\*Linda Bluth  
Kathleen A. Furneaux  
Charley Kennington  
Alexandra Robinson  
Susan Englert Shutrump  
Jean Zimmerman

Leonard J. Bernstein  
Jerry Milliken  
Nancy Netherland  
Launi Schmutz  
Doug Geller

**Editing Committee**

\*Dr. Barbara V. Goodman  
Vernon Wright  
Charlie Gauthier  
Charlie Hood

George F. Horne  
June F. Eanes  
Donald N. Tudor

**School Bus Inspection Writing Committee**

*Bruce Little	James A. Brunet II
Tom Chaffin	Steve Mann
Mark Marino	Robert K. Petersen
Marshall Casey	Verlan Vos
Owen Freese	Kenny Allen
Joseph V. Scesny	John Boster
Chuck Stevenson	William Tousley

**Transportation Security & Emergency Preparedness Writing Committee**

*Pete Baxter	John Green
Bob Pudlewski	Patty Waites
Jim Ellis	Paul Overbaugh

**Technical Review Committee**

*Donald Fowler	Bob Douglas
Gary VanderMolen	Kelly Jenal-Stainbrook
Dan Trexler	Thomas E. McBride

**Special Needs Bus Writing Committee**

*Michael W. Wagner	Jean Zimmerman
Derrick S. Berlin	Barbara A. Hackel
Bette Cotzin	Thomas L. Bever
Janet Kerr	Bruce Barr
Lawrence W. Schneider	Robert Hach
Nancy Ranquist	Jayne Fahle
Kristine Smith	Joanne Ivory
Judy Marks	Linda Hauser
Phillip Stanley Paige	Phillip Beckham
Mark W. Snyder	David Peterson
Peter J. Grandolfo	



# **Roster**

**14th National Congress  
on School Transportation**

**Delegate and Alternate  
List**





**14<sup>th</sup> National Congress on School Transportation**  
**Official Delegate and Alternate List**  
**\*Delegation Chair**

**Alabama (D6)(Alt 0)**

\*Joe Lightsey  
Greg Ray  
Dennis Johnson  
Terry Price  
Robert Turner  
Preston Ferrell

**Alaska (D6)(Alt 0)**

\*Eddy Jeans  
Danny Allen  
Steven Kalmes  
Scott Schwald  
Virgil Adams  
Dennis Cook

**Arizona (D6)(Alt 0)**

\*Art Eagar  
Jay Morris  
Keith Bee  
Gabe Cachora Sr.  
Debbie Lattimore  
Kathy Roadlander

**Arkansas (D5)(Alt 0)**

\*Mike Simmons  
Rick Bane  
Mike Hennessee  
Tom Farmer  
Tommy Davenport

**California (D5)(Alt 0)**

\*John Green  
Dano Rybar  
Anna P. Borges  
Robert Wigginton  
Mike Chaffee

**Colorado (D5)(Alt 0)**

\*Bruce Little  
Shelly Galloway  
Pauline Gervais  
Bob Robbins  
Larry Estrada

**Connecticut (D2)(Alt 0)**

\*David Maestrini  
Anthony Verillo

**Delaware (D7)(Alt 0)**

\*Ronald Love  
Bob Laws  
Don Hartwig  
Mark Wilson  
Lee Dean  
George Middleton  
Wendell Davis

**Florida (D6)(Alt 0)**

\*Charlie Hood  
Karen Strickland  
Mike Connors, CDPT  
Linda Fultz  
Jerry Klein  
Bill Schroyer

**Georgia (D7)(Alt 0)**

\*Bill Simpson  
George Davis  
Carroll Pitts  
Carlton Allen  
Doug Ayers  
Slade Helmly  
Rick Wheeler

**Hawaii (D4)(Alt 0)**

\*Lee Gomes  
David Gomes  
Scott Iwamoto  
Pauline Rivera

**Idaho (D7)(Alt 0)**

\*Rodney D. McKnight  
Ray Mercial  
Rick Vertrees  
Kelly Hill  
Lon Blades  
Brad Jensen  
William R. Dyas

**Illinois (D7)(Alt 0)**

\*Cinda Meneghetti  
Karen Rolofson  
Barbara Rizzo  
Tony Klasing  
Joanne Ivory  
Michael Wagner  
Raymond J. Gawron

**Indiana (D7)(Alt 2)**

\*Pete Baxter  
Chris Barr  
Patty Waites  
Cathy Phillip  
Doug Cauble  
Terri Roesler  
Tobi Gummer  
Alternates  
Monica Coburn  
Susan Henderson

**Iowa (D7)(Alt 0)**

\*Max C. Christensen  
Owen Freese  
Verlan Vos  
Danny Schultz  
Danny Thede  
Ken Dokter  
Julia Thorius

**Kansas (D7)(Alt 1)**

\*Larry E. Bluthardt  
Debora L. Romine  
Sid Cooley  
Barbara Pringle  
Richard Fairchild  
Katie Ruthi  
Nancy Schulz  
Alternate  
Jack Woolf, CDPT

**Kentucky (D7)(Alt 2)**

\*Kyna Koch  
Bobby Galloway  
Dave Mangum  
Larry Fohl  
Gary Skees  
Tom Bach  
Glenn Powell  
Alternates  
Joe Brashear  
Jim Stewart

**Louisiana (D3)(Alt 0)**

\*George Horne  
Laurence P. Ourso  
W. R. "Buster" Flowers

**Maine (D5)(Alt 0)**

\*Harvey Boatman  
George P. Jones III  
David Leavitt  
Robert Metivier  
Timothy Gallant

**Maryland (D7)(Alt 0)**

\*Edward Beck  
H. Winship Wheatley  
Glenn Johnson  
Linda Fitchett  
Jay Walbert  
Santy Disabatino  
Linda Bluth

**Massachusetts (D7)(Alt 0)**

\*Judith A. Dupille  
 Michael Devaney  
 Margaret Rohanna  
 Clifton Johnson  
 Richard Jacobs  
 Mark LaFrance  
 Peter Crossan

**Michigan (D6)(Alt 0)**

\*William Tousley  
 Vincent Weiler  
 Matthew Losch  
 Dale Goby  
 Kellie Dean  
 Kim Hooper

**Minnesota (D7)(Alt 0)**

\*Duane Bartels  
 Mike Moran  
 Jan Dittbrenner  
 Denny Coughlin  
 Bob Fischer  
 Robert Duncan  
 Tom Hey

**Mississippi (D6)(Alt 0)**

\*Leonard C. Swilley, Sr.  
 William C. Carter  
 Lonnie Cox  
 Benjamin L. Mills  
 Samuel Bailey  
 Randall Livingston

**Missouri (D7)(Alt 3)**

\*Tom Quinn  
 Debra Clink  
 Jerry Schwartz  
 Nick Boren  
 Stephanie Brooks  
 David Perkins, Lt.  
 Jerry Sides

## Alternates

Donald Fowler  
 David Wilson  
 Jeff Reitz

**Montana (D7)(Alt 0)**

\*Maxine Mougeot  
 Steve Klippenes  
 Roger Lunde  
 Patrick Sanders  
 Nick Clawson  
 Jerry Fleege  
 Robert Evans

**Nebraska (D7)(Alt 1)**

\*Arthur Keller  
 Russ Inbody  
 Janice Eret  
 Scott Summers  
 David Wolfe  
 Bill McCoy  
 Larry Schweitzer

## Alternate

Fred Craigie

**Nevada (D2)(Alt 0)**

\*Kevin Curnes  
 Steve Clifford

**New Jersey (D7)(Alt 1)**

\*Mark Marino  
 William Reed  
 Dennis Hammell  
 Glenn Barry  
 Timothy Wallace  
 Jerry Ford  
 Ingrid Reitano

## Alternate

Patricia A. Bye

**New Mexico (D5)(Alt 0)**

\*Gilbert A. Perea  
 Carlos Santiago  
 Geoff Rodgers  
 Billy Huish  
 Mike Whitehead

**New York (D7)(Alt 3)**

\*Marion Edick  
Joseph Scesny  
Patricia Bailey  
Timothy Flood  
Carolyn Neder  
Kathy Furneaux  
Michael Nuber

Alternates

James Minihan  
Gary Catapano  
Pete James

**North Carolina (D7)(Alt 0)**

\*Derek Graham  
Harold Laflin  
Phillip Benton  
Charles Ball  
Toni Parlier  
William (Chip) Smith  
Jerry Wynne

**North Dakota (D2)(Alt 0)**

\*Barry Brooks  
Jason Hageness

**Ohio (D7)(Alt 0)**

\*Pete Japikse  
George Sontag  
Barb Wallace  
Darrell Cook  
Phil Rutledge  
John Boster, Lt.  
Shirley Leonard

**Oklahoma (D6)(Alt 0)**

\*Randy McLerran  
Dianna Calvert  
Casey Blackford  
Jim Taylor  
Chuck Lawson  
Billy Whittenburg

**Oregon (D7)(Alt 0)**

\*Deborah Lincoln  
Craig Pruitt  
Steven Huillet  
George Ehmer  
Steve Hendrickson  
Chuck Beck  
David Farley

**Pennsylvania (D7)(Alt 0)**

\*Chris Miller  
Selina Pittenger  
Gail Wolfel  
Wayne Johnston  
Carl Palmeri  
Toni Pulcini  
Huston Lewis

**Rhode Island (D1)(Alt 0)**

\*Walter D. Kettelle

**South Carolina (D7)(Alt 1)**

\*Donald Tudor  
Marshall Casey  
Doug Hamrick  
John Dozier  
June Weaver  
Ginny Burden  
Jeanette Skinner

Alternate

Richard Podmore

**South Dakota (D4)(Alt 0)**

\*Rick Meyer  
Tim Steichen  
Val Nardini  
Ron Block

**Tennessee (D6)(Alt 0)**

\*Larry Riggsbee  
Carlisle Beasley  
Sam Cameron  
Ray Robinson, Lt.  
Mike Simpson  
Keith Phillip

**Texas (D7)(Alt 2)**

\*Charley Kennington  
Carl Kirst  
Mike Cano  
Jim Norman  
Marisa Weisinger  
Willie Tarleton  
Don Davenport

Alternates

Sam Davila  
Sharon Spears

**Utah (D7)(Alt 0)**

\*Brent Huffman  
Bill Lundin  
Wayne Reese  
Zane Woolstenhulme  
Tom Given  
Howard Madsen  
Jean Cannon

**Virginia (D5)(Alt 0)**

\*Barbara V. Goodman  
Harold Grimes  
Tom Williams  
John W. Hazelette  
Kermit Shaffer

**Washington (D7)(Alt 2)**

\*Allan J. Jones  
Mike Kinney  
Skip Enes  
Randy Millhollen  
Robert Petersen  
Ron Lee  
Rick Lecker

Alternates

Dan Cools  
G. Reg Clarke

**West Virginia (D5)(Alt 0)**

\*Benjamin Shew  
Patty Pauley  
Steve Bradley  
Woodrow Wilson  
Robert Summerfield

**Wisconsin (D5)(Alt 0)**

\*Robert W. Christian  
Tom Westlund  
Dan Kobussen  
Peter Grandolfo  
Gerry Sonnabend

**Wyoming (D7)(Alt 0)**

\*D. Leeds Pickering  
Knowles B. Smith  
Kirk Schmidt  
Doug Runyan  
Randy Jensen  
George Dickerson  
Dennis Wegner



# **Roster**

---

**14th National Congress  
on School Transportation**

**Attendance List**





**14<sup>th</sup> National Congress on School Transportation**  
**Official Delegate and Alternate List**  
**\*Delegation Chair**

Douglas K. Abbey  
Sales Manager  
Bus Parts Warehouse  
PO Box 441, 1 Thermold Dr.  
Manlius, NY 13104

Percy Abbott  
Vice-President for Safety  
First Student, Inc.  
705 Central Ave., Suite 300  
Cincinnati, OH 45202

Virgil Adams  
Supervisor of Vehicle Maintenance  
Anchorage School District  
3580 E Tudor Road  
Anchorage, AK 99507

Carlton Allen  
Consultant, Pupil Transportation  
Georgia Department of Education  
1654 Twin Towers East  
Atlanta, GA 30334

Danny Allen  
Alaska State School Bus Inspector  
HC 03 Box 8442C  
Palmer, AK 99645

Devie D. Allen  
Guest/Inspector  
Resurrection Auto/State Inspector  
HC03 Box 8442-C  
Palmer, AK 99645

Kenny Allen  
Specifications Coordinator  
Blue Bird Body Company  
P.O. Box 937  
Fort Valley, GA 31030

Captain Doug Ayers  
Georgia Dept. of Motor Vehicle Safety  
2206 East View Parkway  
Conyers, GA 30013

Tom Bach  
Transportation Director  
Kenton County Schools  
11094 Madison Pike  
Independence, KY 41051

Patricia Bailey  
Transportation Director  
Syracuse City Schools  
369 6th North Street  
Syracuse, NY 13208

Samuel Bailey  
Transportation Director  
Biloxi Public Schools  
341 Agincourt Avenue  
Biloxi, MS 39531

Charles Ball  
Transportation Consultant  
North Carolina Department of Public Instruction  
2570 West Mountain Street  
Kernersville, NC 27284

Rick Bane  
Transportation Director  
Conway School District  
1203 Davis Street  
Conway, AR 72032

Chris Barr  
Trooper  
Indiana State Police  
5252 Decatur Blvd., Suite J  
Indianapolis, IN 46241

Glenn Barry  
Supervisor of Transportation  
Hunterdon Central Regional High School  
84 Route 31  
Flemington, NJ 08822

\*Duane Bartels  
Commercial Vehicle Inspector  
Minnesota State Patrol  
1110 Centre Pointe Curve, Suite 410  
Mendota Heights, MN 55120

\*Pete Baxter  
Director, Division of School Traffic Safety  
& Emergency Planning  
Indiana Department of Education  
Room 229 State House  
Indianapolis, IN 46204

Carlisle Beasley  
Retired Director of Transportation  
Metro Nashville Schools System  
4723 Benton Smith Road  
Nashville, TN 37215

Chuck Beck  
Transportation Maintenance Supervisor  
Beaverton School District  
10420 SW Allen Blvd.  
Beaverton, OR 97005

\*Edward Beck  
Director of Pupil Transportation  
Maryland State Department of Education  
200 West Baltimore Street  
Baltimore, MD 21201

Keith Bee  
Owner  
Bee Line Bus Transportation L.L.C.  
P.O. Box 19342  
Phoenix, AZ 85005

Phillip Benton  
Director of Transportation  
Stokes County Schools  
3160 NC 75 Hwy. W  
Germanton, NC 27019

Brandon Billingsley  
Vice President  
Heavy Duty Bus Parts  
17850 I-45  
Willis, TX 77318

Casey Blackford  
CDL Coordinator  
Oklahoma Department of Public Safety  
P.O. Box 11415  
Oklahoma City, OK 73136

Lon Blades  
Transportation Supervisor  
Joint School District No. 171  
1125 Ahsahka Road  
Orofino, ID 83544

Ron Block  
Office Manager  
Harlow's School Bus Service Inc.  
P.O. Box 419  
Webster, SD 57274

Linda Bluth  
Director, Office of Quality Assurance and  
Monitoring  
Maryland State Department of Education  
Division of Special Education/Early  
Intervention Services  
200 West Baltimore Street  
Baltimore, MD 21201

\*Larry E. Bluthardt  
Transportation Director  
Kansas State Department of Education  
120 SE 10th Ave.  
Topeka, KS 66612

\*Harvey Boatman  
State Director  
Department of Education  
23 State House  
Augusta, ME 04333

Nick Boren  
Superintendent  
South Callaway Schools  
10135 State Road C  
Mokane, MO 65059

Anna P. Borges  
CASTO State President  
California Association of School  
Transportation Officials  
P.O. Box 71165  
Bakersfield, CA 93307

John Boster, Lt.  
Ohio State Highway Patrol  
Motor Vehicle Inspection Unit  
1970 West Broad Street, 4th Floor  
Columbus, OH 43223

Steve Bradley  
Executive Director  
Boone County Schools  
69 Avenue B  
Madison, WV 25130

Joe Brashear  
Transportation Director  
Perry County Schools  
315 Park Avenue  
Hazard, KY 41701

Ron Briggler  
Specifications Analyst  
IC Corporation  
751 South Harkrider  
Conway, AR 72034

\*Barry Brooks  
Director of Purchasing/Transportation  
Minot Public Schools  
215 Second Street SE  
Minot, ND 58701

Stephanie Brooks  
Supervisor Administrative Services  
State Schools for Severely Handicapped  
P.O. Box 480  
Jefferson City, MO 65102

Ginny Burden  
Transportation Supervisor  
Dillon School District III  
205 King Street  
Latta, SC 29565

Patricia Bye  
Transportation Supervisor  
Piscataway Twp. Schools  
1515 Stelton Road  
Piscataway, NJ 08854

Corkey Bynum  
Director  
Safety Systems & Controls  
1201 Upland C1  
Houston, TX 77043

Gabe Cachora Sr.  
Transportation Director  
Indian Oasis Baboquivari Unified School Dist  
#40  
P.O. Box 248  
Sells, AZ 85634

Dianna Calvert  
Director of Transportation  
Mustang Public Schools  
906 S Heights Drive  
Mustang, OK 73064

Sam Cameron  
State Director  
Tennessee DPT Education  
710 James Robertson Parkway  
Nashville, TN 37243

Jean Cannon  
Transportation Supervisor  
Box Elden School District  
1675 No. 2000 West  
Brigham City, UT 84302

Mike Cano  
Transportation Director  
Pharr San Juan Alamo ISD  
P.O. Box 49  
San Juan, TX 78216

Dwight Carlson  
Conference Chair  
4217 Mary Lynn Drive  
Urbandale, IA 50322

Don M. Carnahan  
Vice President, Business Development,  
Pupil Transportation  
Zonar Systems, LLC  
19518 International Blvd.  
Seattle, WA 98188

William C. Carter  
Supervisor of Pupil Transportation  
Mississippi Department of Education  
359 N. West Street, Suite 182  
Jackson, MS 39201

Marshall Casey  
Director of Maintenance  
South Carolina Department of Education  
1429 Senate Street - Rm. 209  
Columbia, SC 29201

Gary Catapano  
National Trainer  
First Student Inc.  
22 Greeley Street  
Merrimack, NH 3054

Doug Cauble  
Director of Transportation and Facilities  
Brown County School Corporation  
357 Main Street  
P.O. Box 38  
Nashville, IN 47448

Mike Chaffee  
MCSI  
California Highway Patrol  
444 North 3rd Street, #310  
Sacramento, CA 95814

\*Max C. Christensen  
Director of Transportation  
Iowa Department of Education  
East 14th & Grand Avenue  
Des Moines, IA 50319

\*Robert W. Christian  
Executive Director & State Director  
Wisconsin School Bus Association  
P.O. Box 168  
Sheboygan, WI 53082

G. Reg Clarke  
Director of Pupil Transportation  
Edmonds School District  
3009 Alderwood Mall Blvd.  
Lynnwood, WA 98036

Nick Clawson  
Driver trainer/delivery  
I state truck/MAPT  
827 2nd Ave. N.  
Billings, MT 59103

Steve Clifford  
District Transportation Supervisor  
Lyon County School District  
25 E. Goldfield Avenue  
Yerington, NV 89447

Debra Clink  
School Transportation Consultant  
Missouri Department of Elementary &  
Secondary Education  
P.O. Box 480  
Jefferson City, MO 65102

Monica Coburn  
Director of Transportation  
Bartholomew Consolidated School  
Corporation  
1260 North Marr Road  
Columbus, IN 47201

Mike Connors, CDPT  
Director of Transportation  
Brevard County School District  
2091 West King Street  
Cocoa, FL 32926

Darrell Cook  
Transportation Director  
Washington Nile Local Schools  
15332 US Hwy 52  
West Portsmouth, OH 45663

Dennis Cook  
Pupil Transportation Coordinator  
Fairbanks North Star Borough School Dist.  
520 5th Avenue  
Fairbanks, AK 99701

Sid Cooley  
Education Program Consultant  
Kansas State Department of Education  
120 SE 10th Ave.  
Topeka, KS 66612

Dan Cools  
Transportation Supervisor  
Medical Lake School District  
P.O. Box 128  
Medical Lake, WA 99022

Denny Coughlin  
Manager, Fleet Operations  
Minneapolis Public Schools  
1001 2nd Avenue North  
Minneapolis, MN 55405

Lonnie Cox  
Transportation Director  
South Pike County School  
994 North Cherry Street  
Magnolia, MS 39652

Fred Craigie  
Assistant Supervisor  
Lincoln Public Schools  
2200 Park Ave.  
Lincoln, NE 68502

Peter Crossan  
Manager-Fleet Maintenance & Contract  
Compliance  
Boston Public Schools  
26 Court Street  
Boston, MA 02108

\*Kevin Curnes  
Transportation Director  
Carson City School District  
352 Sutro Springs Road  
Dayton, NV 89403

Don Davenport  
Transportation Director  
Corpus Christi ISD  
6530 Ranger Ave.  
Corpus Christi, TX 78415

Tommy Davenport  
Transportation Director  
Fayetteville School District  
P.O. Box 849  
Fayetteville, AR 72702

Sam Davila  
Transportation Director  
Conroe ISD  
108 Gladstell  
Conroe, TX 77301

George Davis  
Shop Supervisor  
Fayette County Board of Education  
P.O. Box 879  
210 Stonewall Avenue  
Fayetteville, GA 30214

Wendell Davis  
Region Operations Manager  
First Student, Inc.  
750 Stanton-Christiana Road  
Newark, DE 19713

Kellie Dean  
President  
Dean Transportation, Inc.  
4812 Aurelius Road  
Lansing, MI 48910

Lee Dean  
Transportation Supervisor  
Capital School District  
945 Forest Street  
Dover, DE 19901

Leanna Depue  
Director  
Missouri Safety Center  
CMSU Humphreys 201  
Warrensburg, MO 64093

Jonathan Despres  
Standards and Regulations Technician  
Girardin Minibus Inc.  
Trans-Canada Highway  
Canada, Drummondville, Quebec J2BGV4

Michael Devaney  
Assistant Director of Vehicle Safety &  
Compliance Services  
Registry of Motor Vehicles  
P.O. Box 55892  
Boston, MA 02205

George Dickerson  
Fleet Maintenance Supervisor  
Public School Transportation  
Uinta County School District #1  
537 Tenth Street  
Evanston, WY 82931

Santy Disabatino  
Director of Transportation  
Charles County Public Schools  
P.O. Box 2770  
La Plata, MD 20646

Jan Dittbrenner  
Transportation Director  
A C Enzone  
10709 Whalen Ave. Sout  
Bloomington, MN 55437

Ken Dodson  
Vice President, Engineering  
Thomas Built Buses, Inc.  
1408 Courtesy Road  
High Point, NC 27260

Ken Dokter  
Transportation Supervisor  
Sioux Center Schools  
550 9th Street NE  
Sioux Center, IA 51250

Joe Dominick  
Project Engineer  
Thomas Built Buses, Inc.  
1408 Courtesy Road  
High Point, NC 27260

Ed Donn  
Consultant to Zonar & Busvision  
Donn Associates  
1138 Lovebridge Road NE  
Calhoun, GA 30701

Bob Douglas  
Director of Product Integrity  
IC Corporation  
751 South Harkrider  
Conway, AR 72034

John Dozier  
Director of Training & Safety  
South Carolina Department of Education  
1429 Senate Street, Room 211B  
Columbia, SC 29201

Robert Duncan  
Director of Transportation  
Windom Area Schools  
1400-17th Street  
Windom, MN 56101

\*Judith A. Dupille  
Director of Vehicle Safety & Compliance  
Registry of Motor Vehicles  
P.O. Box 55892  
Boston, MA 02205

William R. Dyas  
Transportation Supervisor  
Melba School District #136J  
611 Randolph  
Melba, ID 83641

\*Art Eagar  
Director of Transportation  
Round Valley Unified School Dist. No. 10  
P.O. Box 610  
Springerville, AZ 85938

\*Marion Edick  
State Director  
New York State Department of Education  
NYSED, 89 Washington Ave., 876 EBA  
Albany, NY 12234

George Ehmer  
Senior Technician-Shop Forman  
City of Milton-Freewater  
722 S Main  
Milton-Freewater, OR 97862

Gray Ellison  
General Manager  
Specialty Mfg.  
10200 Pineville Road  
Pineville, NC 28134

Skip Enes  
Regional Coordinator  
ESD 112  
2500 NE 65th Avenue  
Vancouver, WA 98661

Janice Eret  
Program Specialist  
Nebraska Department of Education  
301 Centennial Mall South  
Lincoln, NE 68509

Larry Estrada  
Transportation Director  
Roaring Fork School District Re-1  
504A 27th Street  
Glenwood Springs, CO 81601

Robert Evans  
Supervisor of Pupil Transportation  
Belgrade Public Schools  
312 N. Weaver  
Belgrade, MT 59714

Jayne Fahle  
Specifications Analyst  
IC Corporation  
751 South Harkrider  
Conway, AR 72034

Richard Fairchild  
Transportation Supervisor  
USD 495 - Fort Larned  
521 Edwards  
Larned, KS 67550

David Farley  
Head Mechanic  
Salem-Kelzer Public Schools  
998 Hawthorne Ave NE  
Salem, OR 97301

Tom Farmer  
Transportation Director  
Bryant School District  
200 Northwest 4th Street  
Bryant, AR 72022

Preston Ferrell  
Baldwin County Assistant Transportation  
Supervisor  
2600-A N. Hand Avenue  
Bay Minette, AL 36507

Theodore S. Finlayson-Schueler  
President  
Safety Rules!  
118 Shirley Rd.  
Syracuse, NY 13224

Bob Fischer  
Pupil Transportation Specialist  
Minneapolis Department of Education  
1500 Hwy 36 West  
Roseville, MN 55113

Richard Fischer  
Owner  
Trans-Consult  
11465 Dallas Road  
Peyton, CO 80831

Linda Fitchett  
Director of Transportation  
Baltimore County Public Schools  
1940-G Greenspring Drive  
Timonium, MD 21093

Jerry Fleege  
Contractor/Transportation Manager  
Harlow's School Bus Service  
75 Yellowstone Road  
Whitehall, MT 59759

Timothy Flood  
Executive Vice President  
The Trans Group, L.L.C.  
56 W. Church Street  
Spring Valley, NY 10977

W. R. "Buster" Flowers  
Supervisor of Transportation and School  
Security  
Webster Parish Schools  
1440 Sheppard Street  
Minden, LA 71055



Larry Fohl  
Transportation Director  
Hardin County Schools  
65 W. A. Jenkins Road  
Elizabethtown, KY 42701

Jerry Ford  
President  
School Transportation Supervisors  
of New Jersey  
P.O. Box 66  
Raritan, NJ 08869

Donald Fowler  
President  
Fowler Bus Company, Inc.  
1213 E. Main St.  
Richmond, MO 64085

Owen Freese  
State School Bus Inspector  
Iowa Department of Education  
East 14th & Grand Avenue  
Des Moines, IA 50319

Linda Fultz  
Director of Transportation  
Hernando County School District  
3339 California Street  
Brooksville, FL 34604

Kathy Furneaux  
Executive Director  
PTSI  
443 South Warren Street  
Syracuse, NY 13202

Timothy Gallant  
Director Buildings, Grounds & Transportation  
M.S.A.D. #43  
3 Recreation Drive  
Mexico, ME 04257

Bobby Galloway  
Transportation Director  
Graves County Schools  
2290 State Route 121 North  
Mayfield, KY 42066

Shelly Galloway  
Transportation Consultant  
Colorado Department of Education  
201 East Colfax  
Denver, CO 80203

Charles Gauthier  
Executive Director  
National Association of State Directors of Pupil  
Transportation Services  
6298 Rock #11 Road  
The Plains, VA 20198

Raymond J. Gawron  
Director of Transportation  
High School District 211  
1750 S. Roselle Road  
Palatine, IL 60067

Raymond J. Gawron  
Director of Transportation  
Township High School District 211  
1750 South Roselle Road  
Palatine, IL 60067

Pauline Gervais  
Transportation Director  
Adams 12 Five Star School Dist.  
444 East 144th Avenue  
Broomfield, CO 80020

Tom Given  
Director of Transportation  
Granite School District  
3000 W Parkway Blvd.  
West Valley, UT 84119

Dale Goby  
Executive Director/Office of Student  
Detroit Public Schools  
8145 Greenfield  
Detroit, MI 48228

David Gomes  
Owner  
Gomes School Bus Service, LTD  
47-114 Wailehua Road  
Kaneohe, HI 96744

\*Lee Gomes  
President  
Hawaii School Bus Association  
47-114 Wailehua Road  
Kaneohe, HI 96744

\*Barbara V. Goodman  
Assistant Director of Pupil Transportation  
Chesterfield County Public Schools  
P.O. Box 10  
Chesterfield, VA 23832

John Goss  
Sales Representative  
Q'Straint  
5553 Ravenswood Road, Bldg. 110  
Ft. Lauderdale, FL 33312

\*Derek Graham  
Section Chief, Transportation  
North Carolina Department of Public  
Instruction  
6319 Mail Service Center  
Raleigh, NC 27699

Peter Grandolfo  
Transportation Director  
Northside Learning Center H.S.  
3730 W. Bryn Mawr Ave.  
Chicago, IL 60659

Ryan Gray  
Senior Editor  
School Transportation News  
700 Torrance Blvd., Suite C  
Redondo Beach, CA 90277

\*John Green  
Supervisor, Office of School Transportation  
California Department of Education  
3500 Reed Avenue  
West Sacramento, CA 95605

Harold Grimes  
Director of Pupil Transportation  
Henrico County Public Schools  
3820 Nine Mile Road  
Richmond, VA 23223

Tobi Gummer  
Administrative Assistant  
Indiana Department of Education  
Room 229 State House  
Indianapolis, IN 46204

Jason Hageness  
Manager  
Harlow's Bus Service, Inc.  
3800 East Century Ave.  
Bismarck, ND 58503

Jason Hageness  
Manager  
Harlows Bus Service  
3800 East Century Ave.  
Bismarck, ND 58503

Jim Haigh  
Vice President, Technical Specifications and  
Application Development  
Transpec Worlwide  
7205 Sterling Ponds Ct.  
Sterling Heights, MI 48312

Steve Hall  
District Sales Manager  
Maxon Lift Corp.  
2620 Crestfield Place  
Round Rock, TX 78681

Dennis Hammell  
Operations Manager  
First Student, Inc.  
P.O. Box 442  
Sparta, NJ 07871

Doug Hamrick  
Director of District Services  
South Carolina Department of Education  
1429 Senate Street - Rm. 210  
Columbia, SC 29201

Don Hartwig  
Transportation Supervisor  
Colonial School District  
1617 Matassino Road  
New Castle, DE 19720

John W. Hazelette  
Director of Transportation  
Norfolk Public Schools  
5555 Raby Road  
Norfolk, VA 23502

Ken Hedgecock  
Vice President-Sales, Marketing & Service  
Thomas Built Buses, Inc.  
1408 Courtesy Road  
High Point, NC 27260

Slade Helmly  
Transportation Director  
Effingham County Board of Education  
P.O. Box 34b  
405 North Ash Street  
Springfield, GA 31329

Susan Henderson  
Director of Transportation  
Franklin Community School Corporation  
750 East State Road 44  
Franklin, IN 46131

Steve Hendrickson  
Vice President of Maintenance Services  
Mid Columbia Bus Co. Inc.  
73458 Bus Barn Lane  
Pendleton, OR 97801

Mike Hennessee  
Transportation Director  
Shirley School District  
154 School Drive  
Shirley, AR 72153

Tom Hey  
President  
Southwest Coaches Inc.  
2660 State Hwy 23  
Marshall, MN 56258

Brian Higginbotham  
General Manager  
Durham School Services  
2911 California Street  
Everett, WA 98201

Kelly Hill  
Transportation Supervisor  
Oneida School District #351  
175 Jenkins Avenue  
Malad City, ID 83252

Len Hindsley  
Application Engineer  
International Truck and Engine Corp.  
PO Box 1109  
Fort Wayne, IN 46801

Steve Hirano  
Editor  
School Bus Fleet Magazine  
3520 Challenger St.  
Torrance, CA 90503

\*Charlie Hood  
Director, Student Transportation  
Florida Department of Education  
325 West Gaines Street, #1144  
Tallahassee, FL 32399

Kim Hooper  
Transportation Consultant  
Wayne County Regional Education  
Services Agency  
33500 Van Born  
Wayne, MI 48161

\*George Horne  
President  
Horne Enterprises  
5017 Bissonet Drive  
Metairie, LA 70003

\*Brent Huffman  
Pupil Transportation Specialist  
Utah State Office of Education  
P.O. Box 144200  
Salt Lake City, UT 84114

Nikki Hughes  
Director of Transportation  
Appendixes Writing Chair  
3050 Orange Grove Avenue  
North Highlands, CA 95660

Steven Huillet  
Consultant  
Oregon Department of Education  
255 Capitol Street NE  
Salem, OR 97310

Billy Huish  
Transportation Supervisor  
Farmington Schools  
3101 Southside River Road  
Farmington, NM 87401

Russ Inbody  
State Transportation Director  
Nebraska Department of Education  
301 Centennial Mall South  
Lincoln, NE 68509

Joanne Ivory  
Director of Safety and Training  
Alltown Bus Service, Inc.  
7300 N. St. Louis  
Skokie, IL 60076

Scott Iwamoto  
Contractor  
Roberts Hawaii School Bus  
680 Iwilei Road, Suite 700  
Honolulu, HI 96817

Richard Jacobs  
Director of Transportation  
Boston Public Schools  
26 Court Street  
Boston, MA 02108

Pete James  
President  
Chautauqua Transportation Services, Inc.  
P.O. Box 1100  
Chautauqua, NY 14722

\*Pete Japikse  
Director of Pupil Transportation  
Ohio Department of Education  
25 South Front Street, Mail Stop 710  
Columbus, OH 43215

\*Eddy Jeans  
Director, Division of School Finance  
Alaska Dept. of Education & Early  
Development  
801 W 10th Street, Suite 200  
Juneau, AK 99801

Kelly Jenal-Stainbrook  
State Certified School Bus Instructor  
Paso Robles Joint Unified School District  
800 niblick Road  
Paso Robles, CA 93446

Brad Jensen  
Transportation Supervisor  
Idaho Falls School District #91  
690 John Adams Parkway  
Idaho Falls, ID 83401

Randy Jensen  
Transportation Director  
School Transportation  
Lincoln County School District #2  
222 E 4th Avenue  
Afton, WY 83110

Clifton Johnson  
Director of Business Development  
Laidlaw Education Services  
39 West Stafford Road  
Stafford Springs, CT 06076

Dennis Johnson  
State School Bus Inspector  
50 N Ripley Street, Room 5303  
Montgomery, AL 36104

Glenn Johnson  
Director of Pupil Transportation  
Howard County Public School System  
10190 Route 108  
Ellicott City, MD 21043

Wayne Johnston  
Director of Transportation  
School District of Springfield Township  
1901 East Paper Mill Road  
Oreland, PA 19075

\*Allan J. Jones  
Director of Pupil Transportation  
OSPI Pupil Transportation  
P.O. Box 47200  
Olympia, WA 98504

George P. Jones III  
President  
Pupil Transportation Consultants, LLC  
P.O. Box 49  
North Salem, NH 03073

Steven Kalmes  
Pupil Transportation Director  
Anchorage School District  
3580 E Tudor Road  
Anchorage, AK 99507

\*Arthur Keller  
Transportation Director  
York Public Schools  
2918 N. Delaware Avenue  
York, NE 68467

\*Charley Kennington  
State Director  
Texas Department of Public Safety  
1617 East Crest Drive  
Waco, TX 76705

\*Walter D. Kettelle  
Transportation Director  
Transportation Consultant  
594 Lafayette Road  
North Kingstown, RI 02852

Mike Kinney  
Regional Coordinator  
ESD 101  
4202 S Regal  
Spokane, WA 99223

Ron Kinney  
Director, Government and Industry Relations  
Laidlaw Education Services  
400 Capitol Mall, Suite 900  
Sacramento, CA 95814

Carl Kirst  
Transportation Director  
Eanes ISD  
601 Camp Craft Road  
Austin, TX 78746

Tony Klasing  
Manager, Vehicle Inspection Unit  
Illinois Department of Transportation  
3215 Executive Park Drive  
Springfield, IL 62794

Jerry Klein  
Administrative Director, Transportation  
Miami-Dade County School District  
15401 Southwest 117th Avenue  
Miami, FL 33177

Steve Klippenes  
Transportation Director  
Lewistown Public Schools  
215 7th Street South  
Lewistown, MT 59457

Dan Kobussen  
Owner  
Kobussen Buses Ltd.  
W. 914 Cth. CE  
Kaukauna, WI 54130

\*Kyna Koch  
Transportation Director  
Kentucky Department of Education  
500 Mero Street  
Frankfort, KY 40601

Dale N. Krapf  
Chairman of the Board  
Krapf Bus Companies  
495 thomas Jones Way, Suite 300  
Exton, PA 19341

Harold Laflin  
Director of Transportation  
Buncombe County Schools  
74 Washington Ave.  
Asheville, NC 28804

Mark LaFrance  
Project Manager  
Massachusetts Registry of Motor Vehicles  
P.O. Box 55892  
Boston, MA 02205

Debbie Lattimore  
Director of Transportation  
Cottonwood-Oak Creek School Dist.  
One North Willard Street  
Cottonwood, AZ 86326

Bob Laws  
Transportation Supervisor  
Christina School District  
400 Wyoming Road  
Newark, DE 19711

Chuck Lawson  
Director of Transportation  
Mustang Public Schools  
P.O. Box 188  
Geary, OK 73040

David Leavitt  
Director of Transportation  
M.S.A.D. #9  
108 Learning City  
Farmington, ME 04938

Rick Lecker  
Transportation Manager  
Longview School District  
2080 38th Avenue  
Longview, WA 98632

Ron Lee  
Transportation Director  
North Kitsap School District  
9916 NE West Kingston Road  
Kingston, WA 98346

Robin L. Leeds  
Industry Specialist  
National School Transportation Association  
133 Jerome Avenue  
Burlington, CT 06013

Shirley Leonard  
Transportation Director  
Lake County MRDD  
8121 Deepwood Boulevard  
Mentor, OH 44060

Huston Lewis  
Coordinator of Driver Training & Certification  
School District of Philadelphia  
734 Schuylkill Avenue  
Philadelphia, PA 19146

\*Joe Lightsey  
Administrator  
P.O. Box 302101  
Montgomery, AL 36130

\*Deborah Lincoln  
Director of Pupil Transportation  
Oregon Department of Education  
255 Capitol Street NE  
Salem, OR 97310

\*Bruce Little  
Sr. Transportation Consultant  
Colorado Department of Education  
201 East Colfax  
Denver, CO 80203

Randall Livingston  
Transportation Director  
Louisville Public School  
P.O. Box 909  
Louisville, MS 39339

Matthew Losch  
Executive Director of Operations  
Grand Ledge Public Schools  
220 Lamson Street  
Grand Ledge, MI 48837

Bill Loshbough  
Owner  
ExecuWest Consultants  
P.O. Box 53340 Albuquerque, NM 87153

\*Ronald Love  
State Supervisor  
Delaware Department of Education  
P.O. Box 1402  
Dover, DE 19903

Roger Lunde  
Driver Trainer  
Harlows Bus Service  
P.O. Box 903  
Three Forks, MT 59752

Greg Lundell  
Sergeant  
Utah Highway Patrol  
5500 West Amelia Earhart Drive, Suite 360  
Salt Lake City, UT 84116

Bill Lundin  
Fleet Supervisor  
Washington County School District  
855 E Brigham Road  
St. George, UT 84790

Howard Madsen  
Program Manager Safety Inspection  
Utah Highway Patrol  
5500 West Amelia Earhart Dr., Suite 360  
Salt Lake City, UT 84116

\*David Maestrini  
Lieutenant  
Connecticut Department of Motor Vehicles  
60 State Street  
Wethersfield, CT 06109

Dave Mangum  
Program Consultant  
Kentucky Department of Education  
500 Mero Street  
Frankfort, KY 40601

Steve Mann  
Specifications Coordinator  
Blue Bird Body Company  
P.O. Box 937  
Fort Valley, GA 31030

\*Mark Marino  
Manager  
New Jersey Motor Vehicle Commission  
225 E. State Street  
Trenton, NJ 08066

Ron Marion  
Sales Manager  
Rifled Air Condition  
6116 Old Mendenhall Road  
Archdale, NC 27263

Mike Martin  
Executive Director  
NAPT  
1840 Western Ave.  
Albany, NY 12203

Thomas E. McBride  
Vice President of Operations  
Durham School Services, Inc.  
1957 Country Estates Ct.  
Foristell, MO 63348

Bill McCoy  
Director of Operations  
Lincoln Public Schools  
2200 Park Ave.  
Lincoln, NE 68502

Dave McDonald  
Specifications/Technical Sales Manager  
Rosco Mirror Systems, Inc.  
P.O. Box 213  
Fredericktown, OH 43019

\*Rodney D. McKnight  
Supervisor, Bureau of Finance & Transportation  
Services  
Idaho State Department of Education  
650 W State Street, 2nd Floor  
Boise, ID 83720

\*Randy McLerran  
State Director  
Oklahoma Department of Education  
2500 Lincoln Blvd.  
Oklahoma City, OK 73105



Herbert Mehnert  
Engineering  
Freightliner Custom Chassis  
552 Hyatt Street  
Gaffney, SC 29341

\*Cinda Meneghetti  
Director of Pupil Transportation  
Illinois State Board of Education  
100 North First Street - E320  
Springfield, IL 62777

Ray Merial  
Coordinator, Pupil Transportation  
Idaho State Department of Education  
650 W State Street, LBJ Bldg. 2nd Floor  
Boise, ID 83720

Robert Metivier  
Director of Support Services  
M.S.A.D. #59  
55 Weston Avenue  
Madison, ME 04950

\*Rick Meyer  
President  
B-J School Buses Inc.  
Box 507  
Scotland, SD 57059

George Middleton  
Transportation Supervisor  
Red Clay Consolidated School Dist.  
479 Old Airport Road  
New Castle, DE 19720

Bruce Miles  
Manager, Validation & Policy (Engineering)  
Blue Bird Body Company  
P.O. Box 937  
Fort Valley, GA 31030

\*Chris Miller  
State Director  
Pennsylvania Department of Transportation  
1101 South Front Street  
Harrisburg, PA 17106

Randy Millhollen  
Regional Transportation Manager  
PSESD  
3601-20th Street East  
Fife, WA 98424

Jerry B. Milliken  
Director  
Roane County Schools  
813 Capitol Street  
Spencer, WV 25276

Benjamin L. Mills  
Transportation Director  
West Point Schools  
P.O. Box 656  
West Point, MS 39773

James Minihan  
Transportation Supervisor  
Katonah-Lewisboro School District  
P.O. Box 387  
Katonah, NY 10536

Rusty Mitchell  
Manager, Product Development  
Blue Bird Body Company  
P.O. Box 937  
Fort Valley, GA 31030

William D. Moore  
Executive Director  
Connecticut School Transportation Association  
135 Day Street  
Newington, CT 06111

Mike Moran  
CEO  
Reichert Bus  
8342 Industrial Park Road  
Baxter, MN 56425

Jay Morris  
Director of Transportation  
Gilbert Public Schools  
140 S. Gilbert Road  
Gilbert, AZ 85296

\*Maxine Mougeot  
State Director  
OPI-Montana  
P.O. Box 202501  
Helena, MT 59620

Val Nardini  
Safety Director  
School Bus Inc.  
5100 W 8th Street  
Sioux Falls, SD 57017

Rod Nash  
Vice President of Engineering  
Collins Industries, Inc.  
15 Compound Drive  
Hutchinson, KS 67502

Carolyn Neder  
President  
G&G Bus Service Inc.  
P.O. Box 626  
Florida, NY 10921

Jim Norman  
Transportation Director  
Bowie County Schools  
P.O. Box 607  
New Boston, TX 75570

Michael Nuber  
Supervisor of Motor Vehicle Insp.  
New York State Department of Transportation  
333 E. Washington Street  
Syracuse, NY 13202

Laurence P. Ourso  
Education Program Consultant  
Louisiana Department of Education  
1201 North Third Street  
Baton Rouge, LA 70802

Carl Palmeri  
President  
Palmeri Transportation  
6887 S. Delaware Drive  
Martins Creek, PA 18063

Toni Parlier  
Director of Transportation  
Watauga County Schools  
P.O. Box 1790  
Boone, NC 28607

Patty Pauley  
Director of Transportation  
Cabell County Schools  
1400 College Ave.  
Barboursville, WV 25504

\*Gilbert A. Perea  
Assistant Secretary  
Public Education Department  
300 Don Gaspar  
Santa Fe, NM 87501

David Perkins, Lt.  
Director, Motor Vehicle Inspection Division  
Missouri State Highway Patrol  
General Headquarters, 1510 E. Elm St.  
Jefferson City, MO 65102

Robert Peters  
Director of Transportation  
Liverpool Central Schools  
4101 Longbranch Road  
Liverpool, NY 13090

Robert Petersen  
CVEO 4  
Washington State Patrol  
P.O. Box 42614  
Olympia, WA 98504

Cathy Phillip  
Operations Manager  
Lakeland School Corporation  
200 South Cherry Street  
LaGrange, IN 46761

Keith Phillips  
Director of Transportation  
Metropolitan Nashville Public Schools  
336 Woodycrest Ave.  
Nashville, TN 37210

\*D. Leeds Pickering  
Program Manager-Pupil Transportation  
Wyoming Department of Education  
2300 Capitol Avenue  
Cheyenne, WY 82002

Corinne Pierce  
N/A  
First Student, Inc.  
177 Route 94  
Lafayette, NJ 07848

Selina Pittenger  
Executive Director  
Pennsylvania School Bus Association  
355 N. 21st Street, Suite 200  
Camp Hill, PA 17011

Carroll Pitts  
Executive Director of Transportation  
Cobb County School District  
620 South Cobb Drive  
Marietta, GA 30060

Richard Podmore  
Transportation Supervisor  
York School District One  
1475 E. Liberty Street  
York, SC 29745

Glenn Powell  
Vehicle Maintenance Manager  
Henderson County Schools  
1805 Second Street  
Henderson, KY 42420

Terry Price  
Blount County Operations Manager  
P.O. Box 147  
Cleveland, AL 35049

Barbara Pringle  
Transportation Director  
USD253, Emporia  
P.O. Box 1504  
Emporia, KS 66801

Craig Pruitt  
Consultant  
Oregon Department of Education  
255 Capitol Street NE  
Salem, OR 97310

Toni Pulcini  
Coordinator of Transportation  
Colonial 1U #20  
6 Danforth Drive  
Easton, PA 18045

\*Tom Quinn  
Director of School Governance  
Missouri Department of Elementary &  
Secondary Education  
P.O. Box 480  
Jefferson City, MO 65102

Greg Ray  
State School Bus Inspector  
50 N Ripley Street, Room 5303  
Montgomery, AL 36104

William Reed  
Supervisor SB Operations  
New Jersey Motor Vehicle  
225 E. State Street  
Trenton, NJ 08625

Wayne Reese  
Transportation Supervisor  
Cache County School District  
2063 N. 1200 E.  
North Logan, UT 84321

Ingrid Reitano  
Vice-President  
School Transportation Supervisors  
of New Jersey  
423 Buckelew Ave.  
Monroe, NJ 08831

Jeff Reitz  
Director of Bus Sales  
Central Bus Sales, Inc.  
2450 Cassens Drive  
St. Louis, MO 63026

\*Larry Riggsbee  
Director of Transportation  
Sumner County Schools  
850 Industrial Blvd.  
Gallatin, TN 37066

Pauline Rivera  
School Bus Manager  
Robert's Hawaii School Bus  
680 Iwilei Road, Suite 700  
Honolulu, HI 96817

Barbara Rizzo  
Director of Transportation  
Peotone CUSD 207U  
212 West Wilson Street  
Peotone, IL 60468

Kathy Roadlander  
Director of Transportation  
Stanfield Elementary School  
515 South Stanfield Road  
Stanfield, AZ 85272

Bob Robbins  
Transportation Director  
Peyton School District 23JT  
13990 Bradshaw Road  
Peyton, CO 80831

Alexandra Robinson  
Director, Transportation Services Department  
San Diego Unified School District  
4710 Cardin Street  
San Diego, CA 92111

Ray Robinson, Lt.  
Tennessee highway Patrol  
Pupil Transportation Division  
1148 Foster Ave.  
Nashville, TN 37210

Geoff Rodgers  
Transportation Supervisor  
Los Alamos Public Schools  
PO Drawer 90  
Los Alamos, NM 87544

Terri Roesler  
Director of Transportation  
North Knox School Corporation  
11110 N. SR 159  
Bicknell, IN 47512

Margaret Rohanna  
Transportation Inspector  
DTE-Transportation Division  
One South Station  
Boston, MA 02110

Karen Rolofson  
Transportation Director  
Rolofson Bus Service, Inc.  
301 Rt. 48 NE  
Argenta, IL 62501

Debora L. Romine  
School Transportation Safety Consultant  
Kansas State Department of Education  
120 Southeast Tenth Street  
Topeka, KS 66612

Mike Roscoe  
Director of School Bus Products  
C.E. White Co.  
407 Wells Lane  
Vesailles, KY 40383

Doug Runyan  
Transportation Director  
School Transportation  
Platte County School District #1  
1350 Oak Street  
Wheatland, WY 82201

Katie Ruthi  
Transportation Director  
USD443, Dodge City  
P.O. Box 460  
Dodge City, KS 67801

Phil Rutledge  
Transportation Supervisor  
Carrollton Schools  
529 12th Street Northwest  
Carrollton, OH 44615

Dano Rybar  
Instructor/Coordinator  
California Department of Education  
3500 Reed Avenue  
West Sacramento, CA 95605

Patrick Sanders  
Program Manager/Planner  
Montana DOT  
2701 Prospect Avenue  
Helena, MT 59620

Carlos Santiago  
Transportation Director  
Santa Fe Public Schools  
610 Alta Vista Street  
Santa Fe, NM 87501

Joseph Scesny  
Supervisor of Motor Vehicle Insp. New York  
State Department of Transportation  
4 Burnett Blvd.  
Poughkeepsie, NY 12603

Kirk Schmidt  
Assistant Superintendent  
Fremont County School District #1  
400 Baldwin Creek Road  
Lander, WY 82520

Bill Schroyer  
Director, Fleet Management  
Florida Department of Education  
325 West Gaines Street, #1144  
Tallahassee, FL 32399

Danny Schultz  
Transportation Supervisor  
Spencer Schools  
800 3rd Street  
Spencer, IA 51301

Nancy Schulz  
Training Center Coordinator  
Laidlaw Transportation  
9554 Lackman Road  
Lenexa, KS 66219

Scott Schwald  
Director of Transportation  
Mat-Su Borough School District  
3901 'B' East Bogart  
Wasilla, AK 99654

Jerry Schwartz  
President  
Schwartz Bus Service Inc.  
405 W. Booneslick  
Jonesburg, MO 63351

Larry Schweitzer  
Transportation Supervisor  
Ord Public Schools  
320 N 19th Street  
Ord, NE 68862

Kermit Shaffer  
Director of Transportation  
Spotsylvania County Schools  
8020 River Stone Drive  
Fredericksburg, VA 22407

\*Benjamin Shew  
Executive Director of School Transportation  
West Virginia Department of Education  
1900 Kanawha Blvd. East  
Charleston, WV 25305

Jerry Sides  
General Manager  
Motor Vehicle Student Transportation, Inc.  
11 Judith Ln.  
East St. Louis, IL 62206

\*Mike Simmons  
State Coordinator  
Arkansas Department of Education  
#4 Capitol Mall, Room 105-C  
Little Rock, AR 72201

\*Bill Simpson  
Interim Director, Pupil Transportation  
Georgia Department of Education  
1654 Twin Towers East  
Atlanta, GA 30334

Mike Simpson  
Director of Transportation  
Shelby County Schools  
160 South Hollywood  
Memphis, TN 38002

Gary Skees  
Vehicle Maintenance Section Manager  
Jefferson County Public Schools  
8613 Eula Road  
Louisville, KY 40219

Jeanette Skinner  
Transportation Director  
Chester County School District  
109 Hinton Street  
Chester, SC 29706

Knowles B. Smith  
Director of Transportation  
Teton County School District #1  
P.O. Box 568  
Jackson, WY 83001

William (Chip) Smith  
Driver Education Specialist  
NCDMV-School Bus & Traffic Safety  
Union County Transportation  
201 Venus Street  
Monroe, NC 28112

Doug Snyder  
Vice President  
TransTraks  
1570 Via Capri #2  
Laguna Beach, CA 92651

Mark Snyder  
Sr. Design Engineer  
Thomas Built Buses, Inc.  
1408 Courtesy Road  
High Point, NC 27260

Gerry Sonnabend  
Owner  
Sonnabend Busses Inc.  
125 Francis Street  
Brillion, WI 54110

George Sontag  
Transportation Director  
Centerville Schools  
9605 Normandy  
Centerville, OH 45458

Sharon Spears  
Transportation Director  
Fort Worth ISD  
100 N. University Drive  
Fort Worth, TX 76107

Ricky Stanley  
Technical Sales Manager-Specifications  
Thomas Built Buses, Inc.  
1408 Courtesy Road  
High Point, NC 27265

Tim Steichen  
Transportation Supervisor  
Watertown School District 14-4  
P.O. Box 730  
Watertown, SD 57201

Jim Stewart  
Assistant Transportation Director  
Oldham County Schools  
P.O. Box 294  
Buckner, KY 40010

Karen Strickland  
General Director of Transportation  
Hillsborough County School District  
9455 Harney Road  
Thonotosassa, FL 33592

Robert Summerfield  
Bus Inspector  
West Virginia Department of Education  
1900 Kananha Blvd. East  
Charleston, WV 25305

Scott Summers  
Legal Counsel  
Nebraska Department of Education  
301 Centennial Mall South  
Lincoln, NE 68509

\*Leonard C. Swilley, Sr.  
State Director  
Mississippi Department of Education  
359 N. West Street, Suite 182  
Jackson, MS 39201

Michael Sykes  
Director, Product & Business Development  
U.S. Bus Corporation  
3927 Elizabeth Street  
Richmond, IN 47374

Willie Tarleton  
Transportation Director  
Midland ISD  
P.O. Box 2298  
Midland, TX 79702

Jim Taylor  
In-House Supervisor  
Tulsa Public Schools  
1815 North 77th East Avenue  
Tulsa, OK 74115

Danny Thede  
Transportation Director  
Indianola Community School District  
1304 E 2nd Avenue  
Indianola, IA 50125

Jeff Thomas  
Technical Sales-Specifications  
Thomas Built Buses, Inc.  
1408 Courtesy Road  
High Point, NC 27260

Linda S. Thompson  
Transportation Director  
Fort Osage R1 School District  
2101 N. Twyman Road  
Independence, MO 64058

Julia Thorius  
Bureau Chief  
Department of Education  
East 14th & Grand Avenue  
Des Moines, IA 50319

\*William Tousley  
Transportation Supervisor  
Farmington Public Schools  
32500 Shiawassee Road  
Farmington, MI 48763

Dan Trexler  
Engineering Manager  
Thomas Built Buses, Inc.  
1408 Courtesy Road  
High Point, NC 27260

\*Donald Tudor  
Director of Transportation  
South Carolina Department of Education  
1429 Senate Street - Rm. 209-A  
Columbia, SC 29201

Robert Turner  
Lamar County Transportation Supervisor  
P.O. Box 1379  
Vernon, AL 35592

Gary Vandermolen  
Director Bus Product Center  
International Truck and Engine Corp.  
PO Box 1109  
Fort Wayne, IN 46801

Anthony Verillo  
Sergeant  
Connecticut Department of Motor Vehicles  
60 State Street  
Wethersfield, CT 06109

Rick Vertrees  
President  
Caldwell Transportation Co. Inc.  
3503 S 10th  
Caldwell, ID 83705

Verlan Vos  
State School Bus Inspector  
Iowa Department of Education  
East 14th & Grand Avenue  
Des Moines, IA 50319

Michael Wagner  
President  
Illinois Central School Bus  
802 N. Street  
Mazon, IL 60444



Patty Waites  
Maintenance Supervisor  
Hamilton Southeastern School Corporation  
13337 Cumberland Road  
Fishers, IN 46038

Jay Walbert  
Supervisor of Transportation  
Allegany County Public Schools  
108 Washington Street  
Cumberland, MD 21502

Barb Wallace  
Transportation Director  
Green Schools  
P.O. Box 218  
Green, OH 44232

Timothy Wallace  
President  
Rahway Bus Company  
445 Inman Avenue  
Colonia, NJ 07067

June Weaver  
Safety Officer  
Berkeley County Schools  
107 East Main Street  
Moncks Corner, SC 29461

Dennis Wegner  
Transportation Supervisor  
Public School Transportation  
Park County School District #1  
160 N Evarts  
Powell, WY 82435

Vincent Weiler  
Transportation Director  
Iosco R.E.S.A  
27 N. Rempert Road  
Tawas, MI 48763

Brian Weisinger  
Transportation Director  
Spring ISD  
24037 Hardy Road  
Spring, TX 77373

Marisa Weisinger  
Transportation Director  
Columbia-Brazoria ISD  
P.O. Box 158  
West Columbia, TX 77486

Tom Westlund  
Owner  
Westlund Bus  
P.O. Box 691  
Marinette, WI 54143

H. Winship Wheatley  
Supervisor of Transportation  
Anne Avundel County Public Schools  
188 Green Street  
Annapolis, MD 21401

Rick Wheeler  
Fleet Manager  
Dougherty County Schools  
1730 Rodgers Street  
Albany, GA 31705

Mike Whitehead  
President  
B&G Transportation, Inc.  
P.O. Box 247  
Hobbs, NM 88241

Billy Whittenburg  
Director of Transportation  
Durant Public Schools  
PO Drawer 1160  
Durant, OK 74702

Robert Wigginton  
Director of Transportation  
Rowland Unified School District  
1010 Otterbein Street  
Rowland Heights, CA 91748

Gail Wolfel  
Supervisor for Transportation Services  
Unionville-Chadds Ford School District  
740 Unionville Road  
Kennett Square, PA 19348

Tom Williams  
Transportation Manager  
Washington County School Bd.  
812 Thompson Drive  
Abingdon, VA 24210

Jack Woolf, CDPT  
Sales Representative  
Midwest Bus Sales, Inc.  
313 E. Front Street  
Bonner Springs, KS 66012

David Wilson  
Regional Sales Manager  
Midwest Transit Equipment, Inc.  
9 Courtney Place  
Warrenton, MO 63383

Zane Woolstenhulme  
Business Administrator  
South Summit School District  
375 E. 300 South  
Kamas, UT 84036

David Wilson  
Regional Sales Manager  
Midwest Transit Equipment, Inc.  
P.O. Box 582  
Kankakee, IL 60901

Vernon Wright  
Staff Engineer  
Blue Bird Body Company  
P.O. Box 937  
Fort Valley, GA 31030

Mark Wilson  
Transportation Supervisor  
New Castle Vo-Tech School  
1417 Newport Road  
Wilmington, DE 19804

Jerry Wynne  
Director of Transportation  
Beaufort County Schools  
321 Smaw Road  
Washington, NC 27889

Woodrow Wilson  
Director of Transportation & Safety  
Roane County Schools  
P.O. Box 609  
Spencer, WV 25276

Jean M. Zimmerman  
Supervisor PT/OT  
School District of Palm Beach County  
31 Chestnut Trail  
Tequesta, FL 33469

David Wolfe  
Director of Transportation  
Omaha Public Schools  
3833 North 72nd Street  
Omaha, NE 68134